



Federal Ministry of Health, Nigeria

# National Family Planning/ Reproductive Health

## Service Protocols

Revised edition



**USAID**  
FROM THE AMERICAN PEOPLE







**Federal Ministry of Health, Nigeria**

# **National Family Planning/ Reproductive Health**

## **Service Protocols**

**Revised edition**

This publication may be freely reviewed, quoted, reproduced, or translated, in full or in part, provided the source is acknowledged. The mention of specific organizations or products does not imply endorsement and does not suggest that they are recommended by the Federal Ministry of Health over others of a similar nature that are not mentioned.

© 2010 Federal Ministry of Health Nigeria

First published in 2004 by the Federal Ministry of Health Nigeria with support from USAID-Vision Project.

Reprinted 2005

Revised in 2010 by the Federal Ministry of Health Nigeria with support from Family Health International/Global HIV/AIDS Initiative Nigeria (GHAIN) project.

**ISBN: 978 062 229-3**

**Citation:** Federal Ministry of Health, Nigeria. 2010. National Family Planning/Reproductive Health Service Protocols. xxii + 302 pp.

Updates to the family planning method sections of this service protocol were supported in part by the US Agency for International Development (USAID). Family Health International (FHI) provided assistance to the Nigeria Federal Ministry of Health in the updates. However, the contents of this publication do not necessarily reflect the views of FHI, USAID or the United States Government. Financial assistance was provided by USAID under the terms of the Cooperative Agreement GPO-A-00-05-00022-0, the Contraceptive and Reproductive Health Technologies and Utilization (CRTU) program.

# Contributors

## 2010 review task team

### Technical lead

Prof. Adeyemi Adekunle

### Federal Ministry of Health

Abosedede R. Adeniran

Oluyemisi A. Akinkunmi

Remi M. Bajomo

Nneka N. Oteka

Felicia F. Osobu

Adebusola A. Salako

Hajara B. Yaki

### Family Health International/GHAIN

Christoph Hamelmann

Otto Chabikuli

Mohammed Ibrahim

Solomon Odafe

Rabiatu Abdul-Hadi

Zubaida Abubakar

Crystal Dreisbach

James Falaiye

Halima Mukaddas

Godwin Ondoma

Mariya Saleh

Yelwa Usman

Irina Yacobson

### Centre for Development and Population Activities (CEDPA)

Austine Olufemi Adeyemo

### JHPIEGO

Lydia Airede

## **Nigerian Urban Reproductive Health initiative (NURHI)**

Fatima Bunza

## **Pathfinder International**

Dije Gimba

## **Planned Parenthood Federation of Nigeria (PPFN)**

Damilola Toki

## **Secretariat Support**

Fatima Adebanjo

Biola Akinwande

Helen Boardman

Jacob Emereole

## **2004 review task force members**

Mrs Racheal Adediji

Mrs Abimbola Adegbulugbe

Prof Adeyemi O. Adekunle

Dr Peju Adenusi

Dr A. A. Adetunji

Dr Nike Adeyemi

Dr (Mrs) Bisi Aisien

Mrs Yemisi Akinkunmi

Mrs Stella Akinso

Dr M.S. Amaeshi

Mrs Cecilia Nnonyelum Anumba

Mrs Irebe Anyaji

Mrs Yemisi Ayoola

Dr Magaji Dachi

Dr Akinremi Dada

Dr Bunmi Dosunmu

Mrs O.A. Fatile

Dr Adesegun Fatusi

Mrs M.O. Hanidu

Mrs Mary Hassan  
Mrs Mary Jolaoso  
Dr Susan Kanu  
Mrs Kofo Kolawole  
Dr Josiah Mutahir  
Mrs Beatrice C. Nwibechukwu  
Chimere Nwugo  
Dr Moji Odeku  
Prof O.A. Ojengbede  
Mrs Grace Oluwatoye  
Dr Linus Onoh  
Mrs Bimpe Owolabi  
Mrs Salome Sambo  
Dr Babtunde Segun  
Mrs Julie Thompson  
Mrs Bisi Tugbobo

**Development partners**

John Hopkins University Health Communications Project  
Engender Health  
IntraHealth  
Population Services International (PSI)  
Centre for Development and Population Activities (CEDPA)  
United Nations Population Fund (UNFPA)

**Secretarial and logistic staff**

Mr Babatunde Ahmed  
Mrs Adesola Adesanwo

# Contents

<i>Contributors</i>	<i>iii</i>
<i>Foreword</i>	<i>xii</i>
<i>Acronyms</i>	<i>xiii</i>
<i>Introduction</i>	<i>xvi</i>
<b>Chapter 1: Behaviour change communication and counselling</b>	<b>1</b>
Description	1
Objectives of BCC and counselling	1
Types of counselling	2
Good counselling skills	2
Rights of the client	2
Indications for counselling	3
Counselling groups with special needs	3
Steps for BCC and counselling	8
<b>Chapter 2: History taking and physical examination</b>	<b>27</b>
History taking	27
Follow-up visit	30
Physical examination	31
Systemic examination	35
Pelvic examination	41
Bimanual examination	42
Speculum examination	45
<b>Chapter 3: Basic laboratory tests for family planning</b>	<b>47</b>
Description	47
Objectives	47
Test types	47
Equipment and materials	47
Procedures	49



<b>Chapter 4: Fertility awareness-based methods (natural family planning)</b>	<b>55</b>
Description	55
Objectives	55
Types of fertility-awareness based methods	55
Specific counselling issues	56
Equipment and materials	57
Procedure	57
Instructions to client	57
<b>Chapter 5: Barrier methods of contraception</b>	<b>64</b>
Description	64
Objectives	64
Types of barrier methods	64
Chemical barrier methods	64
Mechanical barrier methods	71
<b>Chapter 6: Oral contraceptive pills</b>	<b>88</b>
Description	88
Objectives	88
Types of oral contraceptive pills	88
Combined pills	89
Progestin only pills	106
Emergency contraception	115
<b>Chapter 7: Injectables</b>	<b>122</b>
Description	122
Objectives	122
Types of injectables	122
Specific counselling issues for progestin only injectable contraceptives	123
Specific counselling issues for combined injectable contraceptives	126
Equipment and materials	128
Procedure	128

<b>Chapter 8: Contraceptive implants</b>	<b>141</b>
Description	141
Objectives	141
Types of contraceptive implants	141
Specific counselling issues	142
Equipment and materials	145
Procedure	146
Follow-up counselling	148
Removing contraceptive implant capsules	148
<b>Chapter 9: Intrauterine devices</b>	<b>159</b>
Description	159
Objectives	159
Types of IUD	159
Specific counselling issues	160
Equipment and materials	164
Time of insertion	164
Procedure	165
Post-insertion procedure	170
Follow-up	174
Removal of IUDs	174
Difficulty in the removal of IUDs	176
<b>Chapter 10: Voluntary surgical contraception</b>	<b>184</b>
Description	184
Objectives	184
Types of VSC	184
Specific counselling issues	186
Eligibility criteria for sterilization (see introduction)	188
Equipment and materials	192
Procedure	192
Client monitoring	193
Post-operative instructions	194
Follow-up visits	194
Complications	197
Clients who fail to show up for surgery	197

<b>Chapter 11: Post-abortion care</b>	<b>198</b>
Description	198
Objectives	198
Equipment and materials	198
Procedure	199
Counselling tips	202
Management of post-abortion complications	203
<b>Chapter 12: Sexually transmitted infections and HIV/AIDS</b>	<b>206</b>
Description	206
Objectives	206
Types of STIs	206
Equipment and materials	207
Procedure for managing STI patients	208
Some common sexually transmitted infections	209
HIV and AIDS	236
Management of a client suspected to have AIDS	236
Assessment of client	236
HIV/AIDS counselling	237
Mother-to-child transmission of HIV	241
<b>Chapter 13: Infertility</b>	<b>245</b>
Description	245
Objectives	245
Types of infertility	245
Equipment and materials	245
Procedure	246
Important issues for counselling infertile couples	247
Assisted reproductive techniques	248
Adoption	248

<b>Chapter 14: Sexual dysfunction</b>	<b>250</b>
Description	250
Objectives	250
Types of sexual dysfunction	250
Equipment and materials	251
Procedure	251
<b>Chapter 15: Cancers of the reproductive organs</b>	<b>253</b>
Description	253
Objectives	253
Types of malignant tumours of the reproductive organs	253
Equipment and materials	254
Procedure	254
Management	255
Prevention	257
<b>Chapter 16: Menopause and andropause</b>	<b>258</b>
Description	258
Objectives	258
Changes that occur in menopause and andropause	258
Equipment and materials	259
History taking and physical examination	259
Signs and symptoms	259
<b>Chapter 17: Management information system</b>	<b>264</b>
Description	264
Objectives	264
Types of information in MIS	264
Types of forms	264
The role of the health provider in MIS	265

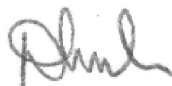
<b>Chapter 18: Clinic management</b>	<b>268</b>
Description	268
Objectives	268
Clinic requirements	268
Setting up a clinic	272
Client flow	273
Clinic hours	273
Staffing and staff management	274
Record keeping	274
Supervision, monitoring and evaluation	274
Defaulter tracing	275
Commodity supply, re-supply and storage	275
Equipment maintenance	276
General	276
<b>Chapter 19: Infection prevention in family planning services</b>	<b>277</b>
Description	277
Objectives	277
Aseptic techniques	277
Processing used instruments and other items	285
Housekeeping	289
Waste disposal	293
Building a simple drum incinerator for waste disposal	296
Making and using a burying site for waste disposal	297
<b>Appendix: Medical eligibility criteria wheel for contraceptive use</b>	<b>298</b>

## Foreword to the 2010 edition

In response to the new global trends in family planning and reproductive health practice, the Nigerian Federal Ministry of Health in collaboration with Family Health International reviewed the *2004 National Family Planning/Reproductive Health Service Protocols*.

The Federal Ministry of Health commissioned a task team to review this document aimed to provide guidance to the delivery of quality reproductive health services in Nigeria. The team updated the document in line with the global best practice in family planning services vis-à-vis the 2008 WHO medical eligibility criteria (MEC).

We hope that the revised 2010 edition of the *National Family Planning/Reproductive Health Service Protocols* will improve technical competence and confidence of service providers, and, ultimately, increase quality and access to family planning services.



**Dr P. N. Momah**

Director, Family Health Division  
Federal Ministry of Health, Abuja

# Acronyms

AI	Artificial insemination
AIDS	Acquired immune deficiency syndrome
ANC	Antenatal clinic/antenatal care
ART	Antiretroviral therapy
BBT	Basal body temperature
BCC	Behaviour change communication
BP	Blood pressure
CEDPA	Centre for Development and Population Activities
CHEWs	Community health extension workers
CIN	Cervical intraepithelial neoplasia/cervical carcinoma in situ
CMM	Cervical mucus method
COCs	Combined oral contraceptives
CRR	Cost recovery record
DCR	Daily consumption record
DMPA	Depot-medroxy-progesterone acetate (Depo-Provera)
DVT	Deep vein thrombosis
EC	Emergency contraception
ECPs	Emergency contraceptive pills
ECS	Endocervical swab
FAB	Fertility awareness based
FEFO	First expiry first out
FGN	Federal Government of Nigeria
FHI	Family Health International
FMOH	Federal Ministry of Health
FP	Family planning
GHAIN	Global HIV/AIDS Initiative Nigeria
GTD	Gestational trophoblastic disease
HAART	Highly active antiretroviral therapy

Hb	Haemoglobin
HIV	Human immuno-deficiency virus
HLD	High-level disinfection
HPV	Human papilloma virus
HSG	Hystero- salpingogram
HVS	High vaginal swab
ICDC	Intracellular diplococci
ICPD	International Conference on Population and Development
IDU	Intravenous drug use
IEC	Information, education and communication
IPC	Interpersonal communication
IUCD	Intrauterine contraceptive device
IUD	Intrauterine device
IVF	In-vitro fertilization
LAM	Lactational amenorrhoea method
LGV	Lymphogranuloma venereum
MCS	Microscopy culture and sensitive
MEC	Medical eligibility criteria
MIS	Management information systems
MTCT	Mother-to-child transmission
MVA	Manual vacuum aspiration
NHMIS	National health management information system
NSAIDS	Non-steroidal anti-inflammatory drugs
NURHI	Nigerian Urban Reproductive Health initiative
PAC	Post-abortion care
PCV	Packed-cell volume
PE	Pulmonary embolism
PHCs	Primary health centres
PID	Pelvic inflammatory disease
PMN	Polymorphonuclear leukocytes
PMTCT	Prevention of mother-to-child transmission
POPs	Progestin-only pills (mini pills)



POC	Products of conception
POP	Progestin only pills
PPFN	Planned Parenthood Federation of Nigeria
PPIUD	Postpartum IUD
PSA	Prostate specific antigen
PSI	Population Services International
RH	Reproductive health
RIRF	Requisition, issue and report form
STIs	Sexually transmitted infections
STM	Sympto-thermal method
TB	Tuberculosis
TBAs	Traditional birth attendants
USAID	United States Agency for International Development
UNFPA	United National Population Fund
VIA	Visual inspection with acetic acid
VHWs	Voluntary health workers
VSC	Voluntary surgical contraception

# Introduction

Reproductive health (RH) received global recognition following the International Conference on Population and Development (ICPD) held in Cairo in 1994. A significant landmark at the ICPD set the shift from family planning to reproductive health with emphasis on improved quality of life. This new paradigm emphasizes integration of reproductive health programs/activities for increased access to services and quality management, thereby enabling clients to receive various health services at a single point or “one-stop-shop”. This further facilitates a multi-sectoral approach to client management and referral linkages, thus improving the quality of care.

In response to the challenges of the ICPD, the Federal Government of Nigeria (FGN) developed the reproductive health policy to address all reproductive health concerns and develop strategies, which respond to the reproductive health needs of the people.

This national family planning/reproductive health service protocol has been reviewed to facilitate the provision of reproductive health services in Nigeria. It aims to improve the quality of care at service delivery points.

## **How to use this manual**

This service protocol is a comprehensive, highly simplified manual, which covers all areas of family planning practice and related reproductive health issues prevalent in Nigeria. It contains 19 chapters and an appendix, which cover all available methods of family planning, sexually transmitted infections (STIs), HIV/AIDS, infertility, routine screening and care for reproductive health cancers, post-abortion care (PAC), and infection prevention techniques. Other related issues discussed in the service protocol are menopause/andropause,

management information systems (MIS), drug interaction, and clinic management.

Each chapter highlights the description, advantages, disadvantages, indications and contraindications to the use, and steps for each procedure. For each family planning method discussed: counselling and screening for medical eligibility, specific counselling issues, contraceptive mechanisms and techniques, management of side effects, complications, and conditions for referral are highlighted.

To use this service protocol, first identify your professional cadre and the procedures you can perform. To perform a particular family planning procedure, look at the table of contents and identify the page where the procedure you require begins. Turn to that page and read the description and objectives (in a box) of the procedure. If the procedure provides a guideline in more than one approach, as in the counselling section, identify the approach that applies to what you are about to do. For example, if you are counselling a couple together, you should follow the guidelines under the column designated as “couple”.

The manual provides you with step by step instructions to perform family planning/reproductive health procedures. Read the procedure you are about to perform before hand to acquaint yourself with the steps. Review it after you have finished performing the procedures, therefore strengthening your skills, confirming the accuracy of performed steps, and ensuring quality of service. Do this until you are comfortable and confident. A few chapters are presented in form of tables and algorithms (decision trees) which should be read downwards, generally from left to right.

Whenever you provide any service to clients let them know that you understand what you are doing and that you care.

Therefore, do not limit the use of this manual to the time you are performing a procedure, but take time to go through the manual whenever you are less busy.

Trainers of family planning/reproductive health providers (pre-service or in-service) can use this manual to assist trainees in acquiring skills in family planning/reproductive health procedures. Consulting this manual will reinforce their learning and help them provide high quality services. In this regard, this National Family Planning/Reproductive Health Service Protocols is a useful reference material for training family planning/reproductive health service providers/trainers.

### **Who is this service protocol for?**

This manual is designed as a systematic instructional document for all cadres of health care providers who have been trained and are working at family planning/reproductive health service points. Users should refer to the standards of practice for family planning/reproductive health services in Nigeria to check the scope of services that can be rendered by different cadres of service providers. The different cadres of service providers are as follows:

Group A: Providers of all methods, including surgical and implant methods — medical doctors.

Group B: Providers of all methods except surgical and implant methods — nurse-midwives, nurses, registered midwives, community health officers, public health nurses, and community midwives health visitors.

Group C: Providers of all methods except surgical methods, implants and IUCD insertion — senior community health extension workers and rural health superintendents.

Group D: Providers of re-supply of oral contraceptives, condoms and foaming tablets — pharmacists, pharmacy assistants, pharmacy technicians, pharmacy attendants, dispensary attendants, patent medicine dealers, nursing aides, nursing assistants, junior community health extension workers, volunteers, community-based distribution agents, village health workers, traditional birth attendants, traditional healers, etc.

### **How to select contraceptive method using WHO medical eligibility criteria (MEC)**

Medical eligibility criteria for each contraceptive method, with the exception of female and male surgical sterilization, were classified using four categories:

1. A condition for which there is no restriction for the use of the contraceptive method
2. A condition where the advantages of using the method generally outweighs the theoretical or proven risks
3. A condition where the theoretical or proven risks usually outweigh the advantages of using the method.
4. A condition which represents an unacceptable health risk if the contraceptive method is used

Category	Description	When clinical judgment is available
1	No restriction to use	Use the method under any circumstance
2	Benefit generally outweigh risk	Generally use the method
3	Risk generally outweigh benefit	Use of the method not usually recommended except if other methods are unavailable/unacceptable
4	Unacceptable Health risk	Method not to be used

Categories for temporary methods		
Category	With clinical judgment	With limited clinical judgment
1	Use method in any circumstances	Yes (Use the method)
2	Generally use method	
3	Use of method not usually recommended unless other more appropriate methods are not available or not acceptable	No (Do not use the method)
4	Method not to be used	

**Recommendation for surgical sterilization are defined according to the following four categories;**

- A (accept) = there is no medical reason to deny sterilization to a person with this condition;
- C (caution) = the procedure is normally conducted in a routine setting, but with extra preparation and precaution;
- D (delay) = the procedure is delayed until the condition is evaluated and/or corrected. Alternative temporary methods of contraception should be provided;
- S (special) = the procedure should be undertaken in a setting with an experienced surgeon and staff, equipment needed to provide general anaesthesia and to back-up medical support. For these conditions the capacity to decide on the most appropriate procedure and anaesthesia regimen is also needed. Alternative temporary method of contraception should be provided, if referral is required or there is otherwise any delay.





# Behavior change communication and counselling

## Description

Behaviour change communication (BCC) is the process of educating, persuading and disseminating information to people, to positively influence their behavioural patterns about a particular (health) issue.

Family planning counselling is a process by which a family planning provider uses appropriate communication skills to provide correct, adequate and unbiased information on available options to an individual, couple or group to help them understand family planning/child spacing. The information provided will enable the client to voluntarily accept family planning and adopt a method of their choice.

## Objectives of BCC and counselling

- To increase awareness about family planning/child spacing methods
- To provide appropriate and clear information about family planning/child spacing to clients
- To promote client-provider interaction in discussing family planning/child spacing
- To assist clients in choosing and adopting a family planning/child spacing method
- To counsel groups that have special needs

## Types of counselling

- Individual counselling – involves the provider and a client
- Couple counselling – involves the provider and a couple
- Group counselling – involves the provider and three or more persons

## Good counselling skills

A good counsellor:

- listens attentively
- is non-judgmental
- respects the client's feelings and values
- ensures confidentiality of client information
- relates to clients in simple and clear language
- provides a good counselling environment

## Rights of the client

The provider should inform every family planning client about his or her right to:

- *Information* – to learn about family planning and the benefits
- *Access* – to obtain services regardless of age, sex, creed, colour, marital status, or location
- *Choice* – to decide freely whether to adopt family planning and which method to use
- *Safety* – to be able to use safe and effective family planning methods
- *Privacy* – to have a private environment during counselling and service provision
- *Confidentiality* – to make any information provided by the client remain confidential
- *Dignity* – to be treated with courtesy, consideration and attention
- *Comfort* – to feel comfortable when receiving services

- *Continuity* – to receive contraceptive services and supplies for as long as required
- *Opinion* – to express their views about the services offered

## Indications for counselling

Family planning counselling is necessary when:

- there is a need to increase awareness and demand for family planning services to improve the quality of life
- there are opportunities for behavioural change communication
  - during client visit to health facilities
  - during health worker's visit to institutions, communities and organizations
  - other opportunities relevant to the local situation.

## Counselling groups with special needs

Counselling may also be required for certain groups of people who have special needs, e.g. menopausal women, andropausal men, adolescents, people who have suffered one form of sexual abuse or the other, and physically or mentally challenged individuals.

### Adolescents

Adolescents include those aged 10–19 years. They undergo physical, emotional and hormonal changes that influence their sexuality and often this makes them take emotional risks as well as risks related to pregnancy, sexually transmitted infections (STIs) and HIV/AIDS. Because they are often subjected to peer pressure and influence, they engage in indiscriminate sexual activities. It is therefore very important to inform and educate adolescents on positive sexual behaviours.

### *Counselling tips*

- Be friendly and accommodating
- Be non-judgmental
- Ensure confidentiality
- Discuss career and life goals and the importance of finishing school in order to achieve these goals
- Encourage discussion about their feelings and beliefs
- Provide comprehensive information on sexual and reproductive health, especially:
  - risks and means of transmission of STIs/HIV and
  - risks of early childbearing and abortion
- Use visual aids
- Arrange clinic sessions in the evenings, at weekends or at periods that are convenient for adolescents (youth-friendly clinic)
- Use peer educators to motivate and educate adolescents

### **Male involvement in reproductive health**

Men are sometimes considered a neglected group in reproductive health/family planning. In the past, they were not regarded as relevant in most programs because reproduction and family planning were not seen as having direct consequences on the health and wellbeing of men and some of the programs were to give women control over their fertility. Men are heads and major decision makers in the family and they exert a lot of influence on women's decisions. Their support and participation can therefore make a big difference in the success of women's effort to adopt family planning. Male participation will improve men's knowledge of family planning and enhance their reproductive health status.

### *Counselling tips*

- Make men feel welcome at the clinic
- Use visual aids that show male examples

- Find out the concerns of men and emphasise the benefit of Reproductive Health in dealing with these concerns, e.g. symptoms of prostatic enlargement, STIs, economic status, children's education, wife's health, etc
- Dispel myths and misconceptions
- Emphasise how men can be supportive of their partner's use of family planning. For example, reminding her to take the pill or helping to insert diaphragm
- Use men as outreach workers to motivate and educate other men
- Encourage men to use family planning methods, such as condoms, abstinence, vasectomy and other reproductive health services
- Arrange clinic sessions in the evenings or at weekends, at a time convenient for men
- Encourage male friendly services

## **Sexual violence**

Sexual violence refers to any form of sexual gesture/activity that is not consented to by the victim, e.g. sexual harassment or rape. Rape victims may present with physical and psychological trauma such as emotional shock, bleeding, swelling and lacerations or medical conditions such as STIs including HIV.

### *Counselling tips*

- Show empathy
- Assist the victim to regain confidence
- Do not be judgmental
- Encourage the victim to report to a law enforcement agency
- Provide opportunities for victim to tell stories of their experience
- Mention the consequences of sexual violence and how to deal with them

- Highlight risk reduction strategies (for example, advise clients to avoid walking alone in dark alleys, etc)
- Provide emergency contraception (refer to Chapter 6)
- Attend promptly to victim and give immediate treatment and counselling
- Liaise with or refer to other NGOs dealing with human rights abuse

### **Mentally and physically challenged clients**

These are people who have mental or physical disabilities and have sexual needs that may not be accommodated by regular services. They may also be subjected to sexual assault. The severity of disability as well as, how much sexual activity is occurring, determine the method of family planning that will best suite client needs and abilities. A client with minor disability can learn about family planning if it is explained patiently and clearly using visual aids.

#### *Counselling tips*

- Re-assure client that their disability does not have to interfere with their sexual life
- Counsel client whose injury or condition might be aggravated by sexual relations, e.g. clients that have spinal injuries may have to use alternatives to traditional sexual intercourse
- Encourage and support the use of a family planning method by clients for whom childbearing will be difficult or pose a further threat to their health
- Refer if necessary

## **Menopause/andropause**

(refer to Chapter 16)

Menopause/andropause can be managed with appropriate medication and counselling.

### *Counselling tips*

- Re-assure client that it is the normal physiological change that takes place in the body
- Dispel myths and misconceptions about andropause and menopause
- Counsel client to have adequate rest and sleep
- Recommend adequate dietary intake with increased fiber and fluid
- Encourage client to take part in spiritual and community activities
- Encourage client to express affection to spouse
- Recommend physical exercises that can alleviate symptoms

## Steps for BCC and counselling

Step	Individual/couple	Group
<b>Preparation</b>		
	<ul style="list-style-type: none"> <li>• Choose a quiet environment that will ensure privacy for the client</li> <li>• A corner of the clinic where another person cannot listen to your conversation with the client/couple or interrupt you</li> <li>• Ensure sitting for the client/ couple</li> <li>• Gather visual aids that are relevant to the culture of the area. Such visual aids may include:               <ul style="list-style-type: none"> <li>• Wall charts on modern family planning methods</li> <li>• Anatomy of male and female reproductive system</li> <li>• Pamphlets developed in the local language</li> <li>• Wall charts on traditional family planning methods</li> <li>• Cue cards</li> </ul> </li> <li>• Place samples of available family planning methods in the counselling rooms</li> </ul>	<ul style="list-style-type: none"> <li>• Inform leaders and authorities within the group and communities and solicit their support</li> <li>• Select appropriate date</li> <li>• Ensure adequate sitting space for all persons expected.</li> <li>• Recognize group or community leaders (male and female)</li> <li>• Gather samples of available contraceptive methods to take to venue</li> </ul>



Step	Individual/couple	Group
<b>Preparation</b>		
	<ul style="list-style-type: none"> <li>• Place a list of common taboos and myths about family planning in the area should be near you for reference</li> </ul>	<ul style="list-style-type: none"> <li>• A list of common taboos and myths about family planning in the area should be near you for reference</li> </ul>
<b>Introduction</b>		
	<ul style="list-style-type: none"> <li>• Greet client and introduce yourself. Use the acceptable local language, e.g. Igbo, Yoruba, Hausa or Pidgin English</li> <li>• English: Good morning. How is everyone at home? Please sit down. I am Mrs. Adeola Ngozi Hassan. How can we be of help to you today?</li> <li>• Create a friendly atmosphere by showing personal interest in comments made by the client/couple</li> <li>• Allow client to speak first. Inform client that whatever they discuss with you will not be disclosed to any other person</li> <li>• Explain to client the process in the clinic, include description of</li> </ul>	<ul style="list-style-type: none"> <li>• Greet group and introduce yourself. If group is less than twelve, encourage self introduction of the group members</li> <li>• Start with a family planning song in the local language</li> <li>• Create a friendly atmosphere by showing personal interest in comments made by group members</li> <li>• Inform clients that whatever they discuss with you will not be disclosed to any other person</li> <li>• Explain to group the process in the clinic,</li> </ul>

Step	Individual/couple	Group
<b>Introduction</b>		
	<p>physical examination and laboratory test</p> <ul style="list-style-type: none"> <li>• Let client tell you how much they know about family planning and modern methods</li> <li>• Briefly describe family planning as a way of having children by choice and of assisting sub-fertile and infertile couples to have children</li> </ul>	<p>include description of physical examination and laboratory test</p> <ul style="list-style-type: none"> <li>• Ask volunteers from the group to say what they know or have heard about family planning methods</li> <li>• Briefly describe family planning as a way of having children by choice and of assisting sub-fertile and infertile couples to have children</li> </ul>
<b>Motivational information</b>		
	<ul style="list-style-type: none"> <li>• Discuss health benefits of family planning. Mention at least five benefits: <ul style="list-style-type: none"> <li>• Reduces maternal and infant death</li> <li>• Allows mother's body to recuperate from previous birth</li> <li>• Promotes health of the children</li> <li>• Promotes family unity and good health</li> <li>• Allows mother to make adequate economic and social contributions to her family</li> <li>• Promotes the health of the community</li> </ul> </li> </ul>	<ul style="list-style-type: none"> <li>• Discuss health benefits of family planning. Mention at least five benefits: <ul style="list-style-type: none"> <li>• Reduces maternal and infant death</li> <li>• Allows mother's body to recuperate from previous birth</li> <li>• Promotes health of the children</li> <li>• Promotes family unity and good health</li> <li>• Allows mother to make adequate economic and social contributions to her family</li> <li>• Promotes the health of the community</li> </ul> </li> </ul>

Step	Individual/couple	Group
<b>Motivational information</b>		
	<ul style="list-style-type: none"> <li>• Helps men provide better life for their families</li> <li>• Explain reproductive tract anatomy and contraceptive methods (display charts). Make short sentences and speak clearly in simple language that the client will understand</li> <li>• Review family planning methods in relation to reproductive tract anatomy and conception</li> <li>• Mention what each method is, how it works, its effectiveness, advantages and disadvantages. Proceed as follows:               <ul style="list-style-type: none"> <li>• Fertility Awareness Based (FAB) method (natural family planning method)</li> <li>• Barrier (chemical or mechanical)</li> <li>• Hormonal</li> <li>• IUD</li> </ul> </li> <li>• If a client already has a method in mind, counsel properly on the method and only briefly mention others</li> </ul>	<ul style="list-style-type: none"> <li>• Helps men provide better life for their families</li> <li>• Explain reproductive tract anatomy and contraceptive methods (display charts). Make short sentences and speak clearly in simple language that the client will understand</li> <li>• Describe in brief the family planning methods available (avoid too much details)</li> <li>• Mention what each method is, how it works, its effectiveness, advantages and disadvantages. Proceed as follows:               <ul style="list-style-type: none"> <li>• FAB method (natural family planning method)</li> <li>• Barrier (chemical or mechanical)</li> <li>• Hormonal</li> <li>• IUD</li> </ul> </li> <li>• Show group all available contraceptive methods and encourage them to visit the nearest family planning clinic for more information and counselling</li> </ul>

Step	Individual/couple	Group
<b>Motivational information</b>		
		<ul style="list-style-type: none"> <li>• Spend more time on the advantages of family planning to mother, father, child, family, community and country. Mention at least 3 each.</li> </ul>
<b>Advantages of family planning</b>		
	<p><i>Mother</i></p> <ul style="list-style-type: none"> <li>• Allows mother's body to rest from last birth thus promoting good health</li> <li>• Allows mother to plan and utilize her time productively</li> <li>• Removes the fear of unintended pregnancy</li> <li>• Promotes mother's nutritional status</li> <li>• Reduces maternal ill health and death</li> </ul> <p><i>Father</i></p> <ul style="list-style-type: none"> <li>• Eliminates the fear of unwanted pregnancy and more mouths to feed</li> <li>• Promotes father's social well being</li> <li>• Allows father to plan for the future of the children</li> </ul>	<p><i>Mother</i></p> <ul style="list-style-type: none"> <li>• Allows mother's body to rest from last birth, thus promoting good health</li> <li>• Allows mother to plan and utilize her time productively</li> <li>• Removes the fear of unintended pregnancy</li> <li>• Promotes mother's nutritional status</li> <li>• Reduces maternal ill health</li> <li>• Enhances appropriate use of resources</li> </ul> <p><i>Father</i></p> <ul style="list-style-type: none"> <li>• Eliminates the fear of unwanted pregnancy and more mouths to feed</li> <li>• Promotes father's social well being</li> <li>• Allows father to plan for the future of the children</li> </ul>

Step	Individual/couple	Group
<b>Advantages of family planning</b>		
	<p><i>Child</i></p> <ul style="list-style-type: none"> <li>• Reduces infant illness and death</li> <li>• Promotes bonding with family</li> <li>• Enjoys opportunity for better life</li> </ul> <p><i>Family</i></p> <ul style="list-style-type: none"> <li>• Enhances the family's nutrition</li> <li>• Promotes economic growth</li> <li>• Promotes education of children</li> </ul> <p><i>Community</i></p> <ul style="list-style-type: none"> <li>• Allows community to plan and manage its resources effectively</li> <li>• Discourages social delinquencies</li> <li>• Promotes community unity</li> <li>• Enhances appropriate use of resources</li> <li>• Reduces infant and maternal illness and death</li> <li>• Reduces teenage pregnancy and abortion</li> <li>• Enables longer breastfeeding period</li> </ul>	<p><i>Child</i></p> <ul style="list-style-type: none"> <li>• Reduces infant illness and death</li> <li>• Promotes bonding with family</li> <li>• Enjoys opportunity for better life</li> </ul> <p><i>Family</i></p> <ul style="list-style-type: none"> <li>• Enhances the family's nutrition</li> <li>• Promotes economic growth</li> <li>• Promotes education of children</li> </ul> <p><i>Community</i></p> <ul style="list-style-type: none"> <li>• Allows community to plan and manage its resources effectively</li> <li>• Discourages social delinquencies</li> <li>• Promotes community unity</li> <li>• Reduces infant and maternal illness and death</li> <li>• Reduces teenage pregnancy and abortion</li> <li>• Enables longer breastfeeding period</li> </ul>

Step	Individual/couple	Group
<b>Advantages of family planning</b>		
	<p><i>Country</i></p> <ul style="list-style-type: none"> <li>• Promotes socio-economic development</li> <li>• Improves quality of life</li> </ul>	<p><i>Country</i></p> <ul style="list-style-type: none"> <li>• Promotes socio-economic development</li> <li>• Improves quality of life</li> </ul>
<b>Specific methods</b>		
	<p><b>Intrauterine contraceptive device (IUD)</b></p> <p><i>What is it?</i> A small flexible plastic frame inserted into the womb to prevent pregnancy</p> <p><i>How does it work?</i> It makes the womb unfavourable to the sperm or egg hence there can be no pregnancy</p> <p><i>Advantage/disadvantages</i> (Refer to Chapter 9)</p> <p><b>Hormonals</b></p> <p><b>Oral contraceptives (pills)</b></p> <p><i>What are they?</i> They are tablets taken orally to prevent pregnancy</p>	<p><b>Intrauterine contraceptive device (IUD)</b></p> <p><i>What is it?</i> A small flexible plastic frame inserted into the womb to prevent pregnancy</p> <p><i>How does it work?</i> It makes the womb unfavourable to the sperm or egg hence there can be no pregnancy</p> <p><i>Advantage/disadvantages</i> (Refer to Chapter 9)</p> <p><b>Hormonals</b></p> <p><b>Oral contraceptives (pills)</b></p> <p><i>What are they?</i> They are tablets taken orally to prevent pregnancy</p>

Step	Individual/couple	Group
<b>Specific methods</b>		
	<p><i>How do they work?</i> When taken regularly as prescribed, oral contraceptives will temporarily prevent the woman's body from releasing eggs from the ovaries. Also thickens cervical mucus making it difficult for sperm to pass through</p> <p><i>Advantages/disadvantages</i> (Refer to Chapter 6)</p> <p><b>Injectables</b></p> <p><i>What are they?</i> Injectables stop ovulation and thicken cervical mucus, making it difficult for sperm to pass through</p> <p><i>Advantages/Disadvantages</i> (Refer to Chapter 7)</p> <p><b>Implants</b></p> <p><i>What are they?</i> Implants are silicon tubes (capsules) containing synthetic hormones inserted under the skin of the upper arm</p>	<p><i>How do they work?</i> When taken regularly as prescribed, oral contraceptives will temporarily prevent the woman's body from releasing eggs from the ovaries. Also thickens cervical mucus making it difficult for sperm to pass through</p> <p><i>Advantages/disadvantages</i> (Refer to Chapter 6)</p> <p><b>Injectables</b></p> <p><i>What are they?</i> Injectables stop ovulation and thicken cervical mucus, making it difficult for sperm to pass through</p> <p><i>Advantages/Disadvantages</i> (Refer to Chapter 7)</p> <p><b>Implants</b></p> <p><i>What are they?</i> Implants are silicon tubes (capsules) containing synthetic hormones inserted under the skin of the upper arm</p>

Step	Individual/couple	Group
<b>Specific methods</b>		
	<p><i>How do they work?</i></p> <ul style="list-style-type: none"> <li>• The contraceptive hormone is released continuously into the body of the woman.</li> <li>• The implant mainly thickens cervical mucus, making it difficult for sperm to pass through pass through it and also prevent the body from producing eggs on a temporary basis</li> </ul> <p><i>Advantages and disadvantages</i> (Refer to Chapter 8)</p> <p><b>Barrier methods</b> (Physical/Mechanical)</p> <p><b>Male condom</b></p> <p><i>What is it?</i> It is a rubber sheath worn on an erect penis before and during sexual intercourse</p> <p><i>How does it work?</i> It prevents the man's sperm from getting into the vagina, hence there can</p>	<p><i>How do they work?</i></p> <ul style="list-style-type: none"> <li>• The contraceptive hormone is released continuously into the body of the woman.</li> <li>• The implant mainly thickens cervical mucus, making it difficult for sperm to pass through pass through it and also prevent the body from producing eggs on a temporary basis</li> </ul> <p><i>Advantages and disadvantages</i> (Refer to Chapter 8)</p> <p><b>Barrier methods</b> (Physical/Mechanical)</p> <p><b>Male condom</b></p> <p><i>What is it?</i> It is a rubber sheath worn on an erect penis before and during sexual intercourse</p> <p><i>How does it work?</i> It prevents the man's sperm from getting into the vagina, hence there can</p>



Step	Individual/couple	Group
<b>Specific methods</b>		
	<p>be no pregnancy when used as instructed. It also prevents sexually transmitted infections</p> <p><b>Female condom</b></p> <p><i>What is it?</i> It is a plastic sheath that is inserted into the vagina before sexual intercourse</p> <p><i>How does it work?</i> It prevents sperm from getting into the womb and prevents sexually transmitted infections</p> <p><i>Advantages and disadvantages</i> (Refer to Chapter 5)</p> <p><b>Diaphragm</b></p> <p><i>What is it?</i> It is a flexible cup-shaped object made of rubber and is inserted into the vagina to cover the neck of the womb</p> <p><i>How does it work?</i> It prevents sperm from</p>	<p>be no pregnancy when used as instructed. It also prevents sexually transmitted infections</p> <p><b>Female condom</b></p> <p><i>What is it?</i> It is a plastic sheath that is inserted into the vagina before sexual intercourse</p> <p><i>How does it work?</i> It prevents sperm from getting into the womb and prevents sexually transmitted infections</p> <p><i>Advantages and disadvantages</i> (Refer to Chapter 5)</p> <p><b>Diaphragm</b></p> <p><i>What is it?</i> It is a flexible cup-shaped object made of rubber and is inserted into the vagina to cover the neck of the womb</p> <p><i>How does it work?</i> It prevents sperm from</p>

Step	Individual/couple	Group
<b>Specific methods</b>		
	<p>entering the womb so that there can be no pregnancy</p> <p><i>Advantages and disadvantages</i> (Refer to Chapter 5)</p> <p><b>Chemical spermicides</b></p> <p>These are foaming tablets, suppositories, cream and jelly</p> <p><i>What are they?</i> They are chemical agents that kill the sperm</p> <p><i>How do they work?</i> When a spermicide is inserted into the vagina before sex, it blocks the entrance of the womb and kills the sperm on contact. The tablet usually produces foam.</p> <p><i>Advantages and disadvantages</i> (Refer to Chapter 5)</p> <p>Voluntary surgical contraception</p>	<p>entering the womb so that there can be no pregnancy</p> <p><i>Advantages and disadvantages</i> (Refer to Chapter 5)</p> <p><b>Chemical spermicides</b></p> <p>These are foaming tablets, suppositories, cream and jelly</p> <p><i>What are they?</i> They are chemical agents that kill the sperm</p> <p><i>How do they work?</i> When a spermicide is inserted into the vagina before sex, it blocks the entrance of the womb and kills the sperm on contact. The tablet usually produces foam.</p> <p><i>Advantages and disadvantages</i> (Refer to Chapter 5)</p> <p>Voluntary surgical contraception</p>

Step	Individual/couple	Group
<b>Specific methods</b>		
	<p><i>What is it?</i> Surgical contraception is a non-reversible permanent method of family planning. It involves a minor operation on either of the partners.</p> <p><i>How does it work?</i> Tubal occlusion – the tubes that carry the woman’s egg into the womb are blocked (show the client the tubal ligation chart). The woman will continue to menstruate till she reaches menopause</p> <p><b>Vasectomy</b> – the tubes that carry the sperm from the man’s testes to the penis are blocked (show client the vasectomy chart). After the operation, the man will not be able to make a woman pregnant, but will continue to be sexually active and produce semen but without spermatozoa. <b><i>The man is not castrated</i></b></p> <p><i>Advantages and disadvantages</i> (Refer to Chapter 10)</p>	<p><i>What is it?</i> Surgical contraception is a non-reversible permanent method of family planning. It involves a minor operation on either of the partners.</p> <p><i>How does it work?</i> Tubal occlusion – the tubes that carry the woman’s egg into the womb are blocked (show the client the tubal ligation chart). The woman will continue to menstruate till she reaches menopause</p> <p><b>Vasectomy</b> – the tubes that carry the sperm from the man’s testes to the penis are blocked (show client the vasectomy chart). After the operation, the man will not be able to make a woman pregnant, but will continue to be sexually active and produce semen but without spermatozoa. <b><i>The man is not castrated</i></b></p> <p><i>Advantages and disadvantages</i> (Refer to Chapter 10)</p>

Step	Individual/couple	Group
<b>Specific methods</b>		
	<p><i>Additional information</i> Surgical contraception is available in selected health facilities around the country. Consult the one nearest to you</p> <p><b>Fertility awareness-based methods</b></p> <p><b>Abstinence</b> Abstinence is the complete avoidance of sexual intercourse</p> <p><b>Calendar/rhythm method</b> With the calendar/rhythm, the couple decides not to have sexual intercourse when the woman is most likely to get pregnant. They count calendar days to identify the start and end of the fertile period. The number of days depends on the length of the previous menstrual cycles</p> <p><i>Advantages and disadvantages</i> (Refer to Chapter 4)</p>	<p><i>Additional information</i> Surgical contraception is available in selected health facilities around the country. Consult the one nearest to you</p> <p><b>Fertility awareness-based methods</b></p> <p><b>Abstinence</b> Abstinence is the complete avoidance of sexual intercourse</p> <p><b>Calendar/rhythm method</b> With the calendar/rhythm, the couple decides not to have sexual intercourse when the woman is most likely to get pregnant. They count calendar days to identify the start and end of the fertile period. The number of days depends on the length of the previous menstrual cycles</p> <p><i>Advantages and disadvantages</i> (Refer to Chapter 4)</p>

Step	Individual/couple	Group
<b>Specific methods</b>		
	<p><b>Billings (cervical mucus) method</b>  The Billings method involves the use of predictable changes in the pattern of cervical mucus to identify when a woman is likely to get pregnant. When a woman sees or feels cervical secretions, she may be fertile and couples using this method must avoid sexual intercourse during this period</p> <p><i>Advantages and disadvantages</i>  (Refer to Chapter 4)</p> <p><b>Basal body temperature (BBT)</b>  A woman's resting temperature increases slightly around the time of ovulation, when she could become pregnant</p> <p><b>Sympto-thermal</b>  Sympto-thermal method is the combination of calendar, temperature and mucus methods to determine when a woman is likely to get</p>	<p><b>Billings (cervical mucus) method</b>  The Billings method involves the use of predictable changes in the pattern of cervical mucus to identify when a woman is likely to get pregnant. When a woman sees or feels cervical secretions, she may be fertile and couples using this method must avoid sexual intercourse during this period</p> <p><i>Advantages and disadvantages</i>  (Refer to Chapter 4)</p> <p><b>Basal body temperature (BBT)</b>  A woman's resting temperature increases slightly around the time of ovulation, when she could become pregnant</p> <p><b>Sympto-thermal</b>  Sympto-thermal method is the combination of calendar, temperature and mucus methods to determine when a woman is likely to get</p>

Step	Individual/couple	Group
<b>Specific methods</b>		
	<p>pregnant. When intercourse is avoided during this period, pregnancy is not likely to occur</p> <p><i>Advantages and disadvantages</i> (Refer to Chapter 4)</p> <p><b>Lactational amenorrhoea method (LAM)</b> When a woman breastfeeds a child exclusively (day and night) she may not ovulate. Therefore, she may not get pregnant</p> <p><i>Advantages and disadvantages</i> (Refer to Chapter)</p> <p><b>Withdrawal method</b></p> <p><i>How does it work?</i> It works by the deposition of sperm into the vagina thus preventing sperm from getting into the womb</p> <p><i>Advantages/disadvantages of all natural family planning methods</i> (Refer to Chapter 4)</p>	<p>pregnant. When intercourse is avoided during this period, pregnancy is not likely to occur</p> <p><i>Advantages and disadvantages</i> (Refer to Chapter 4)</p> <p><b>Lactational amenorrhoea method (LAM)</b> When a woman breastfeeds a child exclusively (day and night) she may not ovulate. Therefore, she may not get pregnant</p> <p><i>Advantages and disadvantages</i> (Refer to Chapter)</p> <p><b>Withdrawal method</b></p> <p><i>How does it work?</i> It works by the deposition of sperm into the vagina thus preventing sperm from getting into the womb</p> <p><i>Advantages/disadvantages of all natural family planning methods</i> (Refer to Chapter 4)</p>

Step	Individual/couple	Group
<b>Interpersonal communication (IPC) skills</b>		
	<ul style="list-style-type: none"> <li>• Encourage client to talk, but avoid making judgmental statements and do not complete statements for the client</li> <li>• Listen to your client carefully instead of thinking of what you have to say</li> <li>• Provide summary of what you have heard periodically</li> <li>• Avoid nervous behaviour, e.g. tapping the table, shaking your head and chewing gum</li> </ul>	<ul style="list-style-type: none"> <li>• Encourage group members to ask questions</li> <li>• Avoid finding faults</li> </ul>
<b>Effective questioning technique</b>		
	<ul style="list-style-type: none"> <li>• Avoid starting a question with “why” at a time.</li> <li>• Wait for an answer</li> <li>• Do not ask client a question that can be answered with Yes or No (it does not help client to talk any further). For example, what does your wife think about family planning?</li> </ul>	<ul style="list-style-type: none"> <li>• Avoid confrontational questions</li> <li>• Deal with confrontational or religious questions in a neutral manner</li> </ul>

Step	Individual/couple	Group
<b>Dealing with untrue information and rumours</b>		
	<ul style="list-style-type: none"> <li>• Encourage client to say more: using words that are appropriate in the client's culture. Use encouragers, e.g. "mm hm", I see, go on, etc.</li> <li>• If the question does not seem to be understood, repeat it in another way</li> <li>• Dispel myths and misconceptions</li> </ul>	<ul style="list-style-type: none"> <li>• Ask audience where they heard these rumours</li> <li>• Discourage them from repeating the false information and rumours</li> </ul>
<b>How to help clients make a choice</b>		
	<ul style="list-style-type: none"> <li>• Find out from client why they want to know more about family planning and about any particular method</li> <li>• Do not try to change client's decision regarding choice of family planning method. Simply inform them about other methods</li> <li>• Politely explain to client that the choice is theirs. However (for IUD, hormonal and surgical contraception), physical examination should be done to ensure that the method is safe for the client</li> </ul>	<ul style="list-style-type: none"> <li>• Give out referral slips to group members so that they can visit family planning clinic convenient for them</li> </ul>



Step	Individual/couple	Group
<b>How to help follow-up clients</b>		
	<ul style="list-style-type: none"> <li>• Welcome client in a friendly manner</li> <li>• Ask after their health and family</li> <li>• Ask the client how you can help</li> <li>• Listen to what the client has to say</li> <li>• Most returning clients may not have problems. However, there are some guidelines on responding to the problems returning clients may have</li> <li>• For all clients making a second visit after initial circle of pills or an insertion of IUD, inform them that the side effects some of them are experiencing may probably stop after the first three months</li> <li>• If client is unable to tolerate the side effects, help choose another method</li> <li>• If a client wants to stop a family planning method, encourage discussion on reasons for stopping</li> <li>• Politely ask what client wants to do, e.g. to use another method or not to use any method.</li> </ul>	<ul style="list-style-type: none"> <li>• Not applicable</li> </ul>

Step	Individual/couple	Group
<b>How to help follow-up clients</b>		
	<ul style="list-style-type: none"> <li>• And if not, ensure that client understands that pregnancy may occur.</li> <li>• If they want to stop the method to have a baby, express interest</li> <li>• Encourage them to talk about their home situation and other children</li> <li>• Encourage them to come back after the birth of their baby to discuss family planning and immunization of the baby</li> </ul>	

# History taking and physical examination

## History taking

### Description

History taking and physical examination involves collecting information from clients on social, medical, gynaecological, obstetric, sexual and contraceptive history during their first visit.

### Objectives

- To foster a positive relationship between the client and provider
- To obtain adequate information for the assessment of physical and psychological status of the client
- To detect personal and family history that may place a client at high risk of using a particular family planning method
- To identify medical disorders that require management

### Types of history taking and physical examination

- At first visit
- At follow-up

### Equipment and materials

- Client record card
- Pen/pencil

## Procedure

### Preparation of materials, equipment and setting

- Make the atmosphere friendly and ensure privacy in the interview area, out of hearing range of other clients and staff (Figure 2.1)
- Get client record card and writing materials ready
- Greet client cordially and introduce self
- Offer client a seat to make them comfortable
- Explain why the questions you're asking are important, particularly those questions the patient may consider private



*Figure 2.1: Physical setting for history taking*

## Social history

- Collect and record client history using the outline provided in the client record card
- Ask about smoking (number of cigarette sticks smoked per day) and drinking (amount of alcohol consumed per day)
- Record the answer in the space next to “smoker”

## **Medical history (past and present)**

Collect information on the following from the client and record:

- Detail of any disease(s), medical/surgical condition, or allergies
- Medication being taken now
- Diabetes mellitus
- Hypertension
- Active tuberculosis
- Surgical operations, which left a scar in the uterus
- Significant weight loss (ask if it bothers the client)
- Sexually transmitted infections
- Recurrent headache
- Thrombosis (blood clot)
- Pain in the calf muscles
- Liver disease or jaundice
- Epilepsy
- Mental illness
- Allergies to drugs

## **Gynaecological/obstetric history**

### **Menstrual history**

Ask questions on the following and record the responses:

- Age at menarche
- Date of last menstrual period
- Amount of flow – heavy, moderate, light
- Duration of menstrual flow
- Interval between two menstrual periods
- Any pain during menstrual period

### **Sexual history**

Ask the following questions and record the responses:

- Age at first sexual intercourse
- How often do you have sexual intercourse?

- How many sexual partners do you have?
- Do you feel pain during sexual intercourse?
- If yes, is it superficial or deep?
- Do you have post-coital bleeding?
- Do you have any vaginal discharge that itches?

### **Obstetric history**

Ask questions on the following and record the responses:

- Number of times pregnant and duration of each pregnancy
- Pregnancy outcome – live births, stillbirths, abortions
- Complications of pregnancy or delivery

### **Contraceptive history**

Ask questions on the following and record the responses:

- Type(s) of method
- Satisfaction with method(s)
- Duration of usage
- Side effects experienced (specify)
- Reasons for discontinuing or changing method

## **Follow-up visit**

### **Objectives**

- To verify and update data collected during the first visit
- To detect any side effects arising from client's chosen contraceptive method
- To review client's medical status since the first visit

### **Procedure**

Preparation of physical setting, equipment and materials: pen/pencil/client record card

Client preparation: same as the first visit

## Steps

- Re-check the name and address of the client

## Medical history

Ask questions on the following and record the responses:

- Any medical problem since client's last visit
- If yes, what was the problem? Has client received any treatment?
- What treatment, where and by whom?

## Gynaecological and contraceptive history

Ask questions on the following and record the responses:

- First day and duration of client's last menstrual period
- Painful or heavy menstruation since last visit
- Regularity of periods

## Physical examination

### Description

Physical examination is the process of assessing the client's health status

### Objectives

- To obtain baseline information on clients
- To identify health condition that may contra-indicate a specific contraceptive method
- To discover any abnormality that may require treatment and manage appropriately
- To detect gynaecological conditions and sexually transmitted infections
- To refer for management where necessary

## **Equipment and materials**

- Blood pressure apparatus (sphygmomanometer)
- Stethoscope
- Weighing scale
- Torch/angle-poised lamp
- Laboratory/pathology/MIS forms
- Pedal bin for soiled dressings
- Trolley
- Bowl for lotion/water
- Bowl for cotton wool/gauze
- Sims/Cusco's speculum (bivalve)
- Gallipot for lubricant
- Sponge holding forceps
- Kidney dish
- Glass slide
- Wooden spatula for cervical smear
- 95% alcohol
- Acetic acid

## **Preparation of client**

- Ensure client's comfort and privacy
- Explain every procedure to the client
- Ask client to empty bladder
- Wash hand with soap and water before and after examining the client (or after having any direct contact)

## **General examination**

This includes inspection and palpation. Observe the following as the client walks into the examination room:

- Gait (walking) – shuffling, limping with or without pain
- Facial expressions
- Pronounced disability or obvious ill-health
- Pallor, jaundice and pedal oedema



*Check temperature, pulse, respiration rate, weight and record*

- Check blood pressure at every visit and record findings
- If there are any abnormalities such as hypertension or hypotension refer for management

## **Procedure for checking blood pressure**

### *Equipment*

- Sphygmomanometer
- Aneroid type
- Mercury type
- Stethoscope

### *Steps*

- Tell the client what you are about to do
- Get the client comfortably seated with arm supported and relaxed, palm surface of arm uppermost
- Position yourself so that the column of mercury can read at eye level and not more than one meter away
- Place the cuff so that the inflatable bag is centred over the brachial artery and lower edge of the cuff is 2 cm above the elbow joint
- Wrap the cuff smoothly around the arm and tuck end of cuff securely under preceding wrap
- Use finger to feel for strong pulsation of brachial artery at the level of the elbow joint
- Place the stethoscope over the brachial artery to listen for the Korotkoff sounds (pulsation)
- Pump the bulb of the manometer until the mercury rises approximately 20-30mm above the point at which the brachial pulse is no longer heard
- Using the valve on the bulb releases air slowly. Note on the manometer, the point at which the *first* sound is heard. This figure is the *systolic pressure*
- Continue to release air in the cuff evenly and gradually

- The last figure on the manometer at which the quality of sound *changes* to a less distinct sound is the *diastolic pressure*
- Allow the remaining air to escape quickly. Remove the cuff
- Record immediate

*Note:* If blood pressure apparatus does not have any mercury, read from the dial (aneroid). Each provider should be familiar with the use of the blood pressure apparatus.

### **Procedure for checking weight**

#### *Equipment*

There are two types of weighing machines:

- Bathroom scale
- Standing scale

*Note:* Each provider should be familiar with the operating manual accompanying the scale in the facility.

#### *Steps*

- Balance the scale at zero
- Ask client to remove shoes, head tie/cap, and other heavy materials such as trinkets
- Ask client to stand on the scale without holding onto anything
- Balance scale weight or read the scale if it is the bathroom type
- Record the client's weight immediately and compare with the weight at last visit

*Note:* Take note of any detected abnormality in the client's card.

## Examination for pallor, jaundice, and pedal oedema

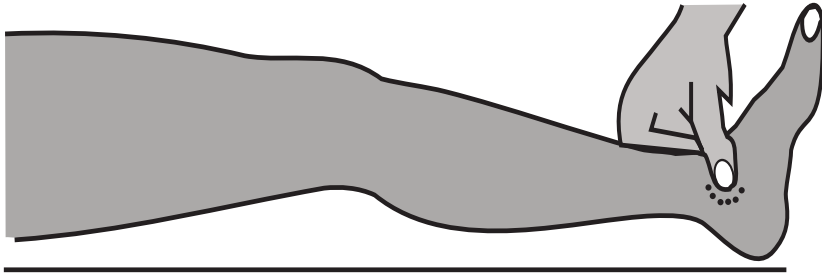


Figure 2.2: Test for pedal oedema

## Systemic examination

Place client in the position most appropriate for examination and check the following:

### Head and neck: *Tinea capitis* (ring worm)

- Face — pimples
- Eyes — jaundice and anaemia
- Mouth — colour of tongue and mucous membrane, ulcers and fissures
- Neck — lumps, including thyroid enlargement and engorged vein

### Breast examination

There are two positions for breast examination: sitting/standing and lying down.

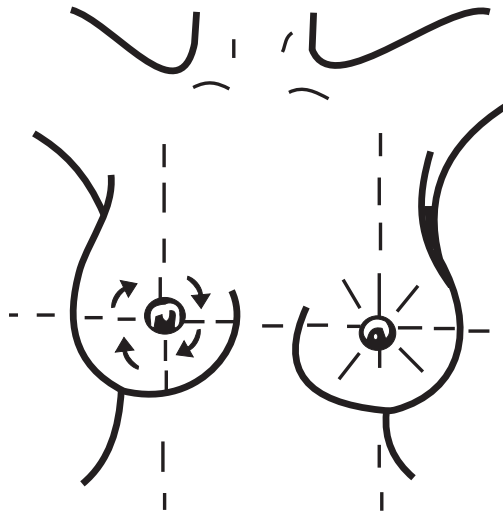
*Sitting/standing:* Preferably before a mirror with client sitting/standing up and with breasts exposed. Inspect:

- the breast for size, shape, symmetry, scars, thickening of the skin, visible lumps, “peau d’orange” (skin looking like orange peel with dimples);
- engorgement, redness, colour of nipples, ulceration;

- dimpling and drawing in of the nipples by asking client to:
  - lift both arms over the head and check if both breasts rise equally
  - lean forward, letting the breasts hang loosely from the chest
  - place hands on hips and press

*Lying down:* flat on the back with head on one pillow:

- Assist client to lie on her back
- Position client's left arm over her head, make imaginary lines dividing the breast into four quadrants and go through the steps (see Figures 2b to 6)
- Hold fingers flat and move gently over each part of breast in a clockwise direction
- Beginning from the outer edge of the quadrant to be examined, palpate towards the nipple with the other hand supporting the breast



*Figure 2.3: Breast examination (breast divided into imaginary quadrants)*

- Next, feel large areas of the breast against the chest wall, checking for any lump, hard knots or thickening
- Bring the client's arm down to her side and feel against the side of the chest the armpit for any lymph node (lump)



*Figure 2.4: Breast examination*

- Repeat with the other breast and armpit
- If lump is present, ask client if she is aware of it
- Ask if the lump is increasing in size or whether it hurts
- Instruct client on self examination of breast, have her perform the examination while you observe and correct
- Encourage the client to examine the breast every month 2-3 days after her menstrual period and report to the provider if there are any changes



*Figure 2.5: Breast examination*



*Figure 2.6: Nipple examination for discharge*



*Figure 2.7: Breast examination for lump*

### **Abdominal examination**

Abdominal examination is conducted to identify deep tenderness and enlargement of organs and obtain information on the size, consistency, tenderness and mobility of a mass and the positions of organs such as the liver and spleen.

#### *Steps*

- Position client on her back with arms at the side and the knees straight
- Cover the client properly and expose only the area for examination
- Inspect for scar of previous operation or traditional marks, distension, lumps and hernias
- Palpate for lumps and hernias

### *Light palpation*

- Using palmer surface of fingers, palpate lightly the entire abdominal wall
- Observe the client's facial expression, which may indicate pain

### *Deep palpation (see Figure 2.8)*

- With one hand behind the lower right chest region, place the other hand on the right lower abdomen with fingers pointed upward
- With each deep breath, move the hand on the abdomen towards the edge of the rib to feel the edge of the liver and the spleen
- Refer to the doctor if liver and spleen are enlarged



*Figure 2.8: Abdominal palpation*

### **Percussion**

If any enlargement is detected, this should be percussed for resonance or dullness (Figure 2.9).



### Steps

- Place the left hand on the client's abdomen with the palm flat and fingers together
- With the first two fingers of the right hand tap on the fingers of the left hand
- Watch client's reaction for expression of pain
- Listen for any sound

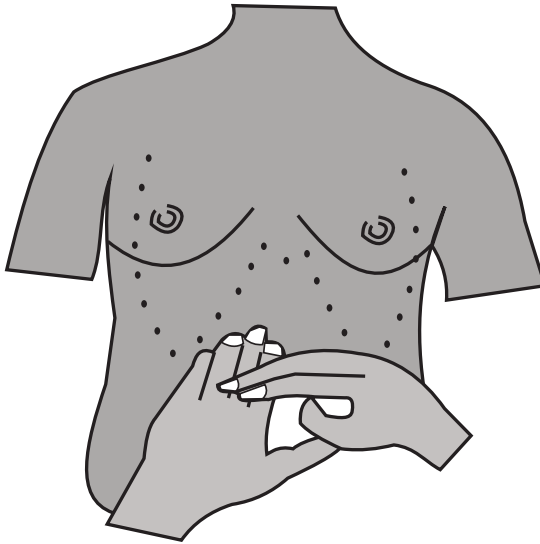


Figure 2.9: Percussion of the abdomen

## Pelvic examination

### Client preparation

- Inform client that you wish to conduct a vaginal examination, and ask for her consent
- Instruct client to lie on her back with the knees bent
- Position the source of light (angle poised lamp or torch)
- Wash hand with soap and water and dry

- Wear clean gloves
- Place kidney dish containing Cusco's or Sim's speculum, sponge holding forceps, lubricant, spatula and swab on a trolley

## Bimanual examination

Inspect external genitalia and note the following:

- Distribution of pubic hair
- Presence of scars, lice, varicose veins, excoriation, bleeding, vaginal discharge, abrasions, rashes, warts and swellings.
- Separate labia majora from labia minora and note evidence of circumcision.
- Observe urethral opening for discharge and signs of inflammation.
- Instruct client to cough and observe closely urine leakage and bulging of vaginal wall indicating urethrocele, cystocoele and/or rectocoele.
- Insert two fingers of examining hand well inside the vagina and feel the vagina walls.
- Using upward pressure, instruct client to cough and observe for bulge in the posterior vagina wall, which might indicate rectocoele.
- With the palm up, using the fingers in the vagina, follow the anterior vaginal wall until you reach the end of it and locate the cervix.
- Feel the cervix with the vaginal fingers, noting the position and consistency of the cervix. Also, determine whether the os is open or closed. Feel the shape of the external os, recognise any old laceration and presence of cyst or polyp seen on speculum examination.
- Steady pelvic organs by placing the abdominal hand

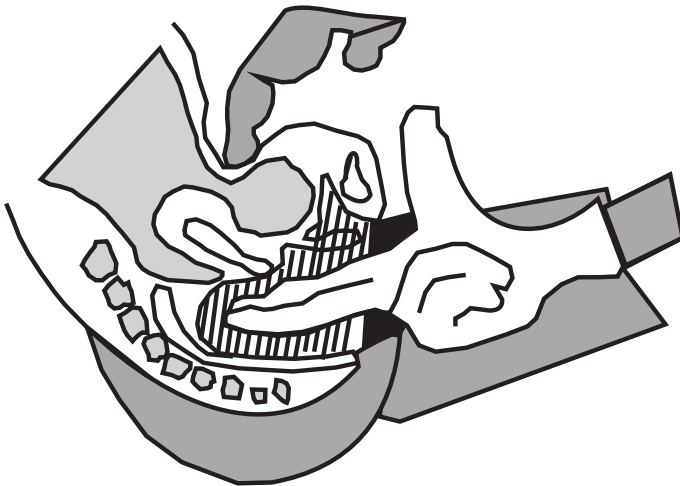
gently over the lower abdomen above the symphysis and exert steady downward pressure.

- With the fingers in front of the cervix, gently lift the fingers inside the vagina towards the abdominal hand to discover if the uterus can be felt in-between the two hands, indicating anterior position of the uterus (anteverted uterus) (Figure 2.10).
- If the uterus is not palpated in front, then place the vaginal fingers behind the cervix and gently lift the cervix and the uterus towards the abdominal hand.
- The mid position situation of the uterus may be determined by this movement (Figure 2.11).
- If the uterus is not felt between the two hands, it may be behind the cervix at the end of the posterior wall of the vagina.

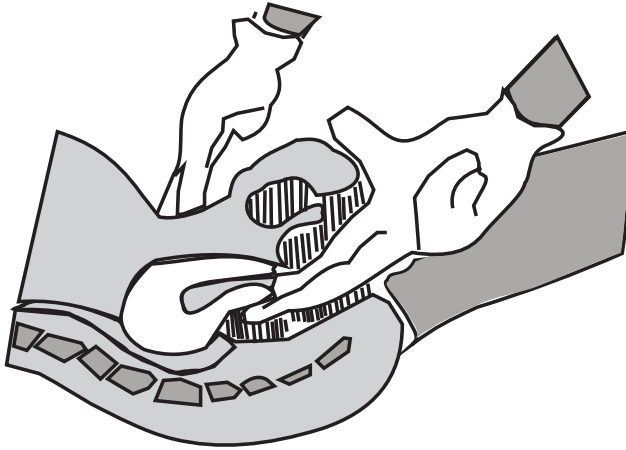


*Figure 2.10: Bimanual examination for anterior position of the uterus*

- Feel the uterus with the tip of your vaginal fingers pointing downwards and backwards. The posterior position of the uterus may be determined by this movement (Figure 2.12).
- Immediately after the position of the uterus is identified, divide the vaginal fingers into a V-shape and with these fingers on either side of the cervix, outline the uterus, noting the size, shape, consistency and mobility of the uterus.
- Move the vaginal fingers into the lateral fornix (the side of the cervix) and simultaneously move the abdominal hand to the same side. While the abdominal hand presses towards the vaginal fingers, identify the presence of swelling, tenderness and thickening.
- Repeat for the other side of cervix.
- Gently remove fingers from the vagina.



*Figure 2.11: Bimanual examination for mid position of the uterus*



*Figure 2.12: Bimanual examination for the posterior position of the uterus*

## Speculum examination

- Inform the client that a speculum will be inserted.
- Lubricate Cusco's or Grave's speculum (use NaCl 0.9% or any other physiologic solution, if specimen for cytology or culture is to be taken).
- Insert the lubricated speculum into the vagina.
- Hold the speculum closed in the right hand and open the labia using the middle and index fingers of the left hand.
- Obliquely insert the blades of the speculum into the vaginal canal. Avoid pressure on the urethra and clitoris. Do not catch skin and hair between the blades and hinges of the speculum.
- Half way into the vaginal canal, turn the blades in the horizontal plane and slowly introduce the speculum further towards the cervix.
- Put a little downward pressure on the floor of the vagina and gently open the blades of the speculum and visualize the cervix

- Inspect the following:
  - cervix for colour, laceration, polyp, erosion, cyst, discharge or bleeding
  - vaginal mucosa for colour, ulcerations (types, consistency and colour)
  - if there is need for cervical acetic test, paint the cervix with acetic acid and observe any change in colour.

*Obtain laboratory specimen (if required)*

*Pap smear*

- Label the cytology slide (name and identification number).
- Insert the pointed edge of the spatula into the cervical canal and gently rotate, scrapping with wooded spatula for a full 360 degree.
- Lightly and evenly spread the material on the labelled slides.
- Fix the material immediately in a fixative (95% alcohol) before it dries up.
  - Avoid taking smear during menstrual flow. However, if a client consults during an abnormal bleeding episode, obtain smear as this may aid diagnosis.
  - Do not use lubrication.
- Use a sterile swab stick to take culture material from endocervical canal. Insert sterile swab stick into the cervical os and gently rotate to obtain specimen and place swab stick into the container.
- Remove the speculum by loosening the screw and using slight downward traction.
- Send specimen to the laboratory immediately as gonorrhoea organisms are sensitive.
- Where laboratory is far away from the health centre, place the specimen in a transport medium and transport to the laboratory.

## Basic laboratory tests for family planning

### Description

Some basic laboratory tests should be available in family planning clinics to exclude or confirm particular situations such as pregnancy and sexually transmitted infections.

### Objectives

- To detect any abnormality in the specimen taken
- To report and treat any abnormality
- To exclude pregnancy
- To screen for cervical pathology

### Test types

- Urinalysis (hot and cold) – albumin, sugar and acetone
- Blood for haemoglobin (Hb), packed-cell volume (PCV), malaria parasites, sickling, HIV, hepatitis B virus
- Pregnancy test
- Other tests such as Papanicolaou (pap) smear, visual inspection with acetic acid (VIA), microscopy, culture and sensitivity for high vaginal swab (HVS), endocervical swab (ECS) and urine

### Equipment and materials

#### General

- Methylated spirit lamp
- Blue/red litmus paper
- Urinometer
- 20% salicyl sulphonic acid

- Acetic acid
- Clinitest tablets
- Acetest reagent tablets
- Sterile swab stick
- Sterile urine container
- Transport medium
- Test tubes
- Test tube holder
- Test tube rack
- Waste bin
- Blood sample bottles
- HIV rapid screening test kits
- HBV rapid test kits

## **Specific**

### *Urinalysis*

- Urine
- Urine Dip sticks (Multisticks/Combi -9 or other test sticks)

### *Blood test*

- Taliquist paper
- Cotton wool swab
- Needle or lancet
- Tourniquet
- Plaster

### *Pregnancy test*

- Pregnancy test kits

### *Pap smear and VIA*

- Speculum
- Sterile swab sticks
- Glass slides
- Wooden spatula



- 95% alcohol
- Acetic acid 3-5%
- Clean gloves

## Procedures

### Urinalysis (detailed examination of urine)

*Note:* Use fresh urine specimen for all tests except pregnancy test, which requires early morning urine. If the client has fever, allow urine to cool to room temperature before the reading is done.

#### *Client preparation*

Instruct client to collect mid-stream sample of urine by passing initial urine out before collecting some into the specimen bottle.

#### *Steps*

Observe the following:

#### *Colour*

- Normal colour is amber
- Abnormal colours:
  - Wine or red indicates blood
  - Orange-brown indicates bile pigments
  - Various colours – as a result of drugs and other substances which have been ingested

#### *Turbidity*

- Normal urine should be clear
- Haziness indicates presence of protein, mucus or pus (suspect urinary tract infection)

#### *Odour*

- Normal: it is aromatic
- Sweet smell indicates presence of acetone
- Fishy odour indicates infection

### *Specific gravity*

- Normal range is 1.010–1.025
- Place the urinometer into a cylinder containing urine
- Allow the urinometer to float freely in the urine without touching the sides or bottom of the cylinder. If there is insufficient urine to allow the urinometer to float freely, then add an equal quantity of water and double the last two figures of the reading obtained.
- Perform this after all other tests have been completed
- Read the number on urinometer at the lower level of the meniscus of urine

### *pH*

Normal urine (pH) is acidic

- Dip litmus paper in the urine for 10–15 seconds (depends on manufacturer's instruction), remove and observe colour change
- Blue litmus paper changed to red indicates acidic reactions
- Red litmus paper changed to blue indicates alkaline reaction
- Purplish colour change in both indicates neutral reaction (other indicator test papers show various pH ranges)

### *Albumin*

- Dip test end of albutix in urine
- Remove immediately
- Compare colour of dipped test end with colour scale on the container (this depends on the manufacturer's instruction)

### **Alternative urine test for protein/albumin**

#### *Salicyl sulphonic acid test*

- Make the test tube three-quarter full with urine
- Add 10–20 drops of 20% salicyl sulphonic acid

- If the solution is cloudy, albumin is present. The degree of cloudiness varies with the amount of albumin present.

#### *Hot test for albumin*

- Make test tube three-quarter full with urine
- Hold the tube at the bottom
- Heat the top over a methylated spirit lamp and shake continuously
- Add a few drops of acetic acid when boiling
- Remove from the flame and read the results
- Cloudiness indicates the presence of albumin

#### *Sugar*

Use either of the following tests:

##### *a. Clinistix (Ames test)*

- Dip the test end into the urine and withdraw
- Observe colour change and compare colour with scale on the container for the presence of glucose

##### *b. Clinitest tablets test*

- Place 5 drops of urine in test tube
- Add 10 drops of water
- Add one clinitest tablet
- Do not shake the mixture while it is bubbling
- Wait for 15 seconds after bubbling stops
- Shake and compare with the colour chart

*Note:* Use the same dropper for urine and water

#### **Blood test**

- Set up the tray
- Ensure that client is positioned comfortably
- Explain the procedure to the client
- With your thumb and index finger, hold the client's thumb firmly

- Clean the tip of the finger with cotton wool swab dipped in methylated spirit and discard swab after use
- Prick the finger tip once sharply with needle or lancet
- Squeeze out the blood
- Clean the first drop of blood
- Blot the next drop of blood on a piece of taliquist paper
- Compare the colour with the one on the taliquist scale

### **Pregnancy test**

Follow the manufacturer's instructions for the kit you have

### **Other tests**

- Routine pap smear (refer to chapter 2)
- Microscopy culture and sensitive (MCS) for abnormal vaginal discharge

#### *Vaginal discharge for culture and sensitivity*

Procedure for obtaining specimen for culture and sensitivity is as follows:

- Insert vaginal speculum (avoid using lubricant except water) and visualize the cervix
- Using a sterile swab, collect a sample of discharge from the cervical opening
- Stick the swab into the transport medium and break off the stick at the level of the bottle
- Screw on the cap immediately
- Label and send to the laboratory

*Note:* Culture and sensitivity should be done where laboratory facilities are available

#### *Urine culture and sensitivity*

Procedure for urine culture and sensitivity is as follows:

- Give a sterile container to the client

- Instruct the client to collect mid-stream urine in the sterile container
- Label and send to the laboratory immediately

### **Visual inspection of the cervix**

- The procedure and reason for inspection should be carefully explained to the woman to be examined and she should be made as comfortable as possible
- Put patient in lithotomy position (if possible) or supine with legs bent at knees
- Good visualization is essential. Direct the light source to the genital area.
- Observe and record any abnormal findings in the external genitalia
- Lubricate the speculum with warm water and insert into the vagina with the speculum closed
- Open the speculum and adjust the light source so as to get a clear view of the cervix
- If there is excess mucus or discharge, clean it with a cotton swab soaked in boiled water or normal saline solution
- Observe any abnormal findings
- Wash the cervix with acetic acid (3-5%) with the help of a syringe
- Wait for approximately one minute and inspect the cervix for acetowhite area(s)

### *Note*

- i. Do not perform the examination if the woman is having her menstrual period or is using intravaginal medication. Advise her to come back when the menses or the treatment is over.
- ii. Do not apply acetic acid if there is a gross lesion suspicious of malignancy, refer patient directly to oncology/tertiary care facility

### **Rapid screening test for HIV**

- Counsel client on HIV test
- If client consents take appropriate sample (blood) for rapid screening test for HIV (follow manufacturer's instruction for the kit available in your facility)

# Fertility awareness-based methods (natural family planning)

## Description

The success of fertility awareness-based methods depends on the ability to recognize certain physiologic changes associated with ovulation. Couples recognize the fertile and infertile phases of the menstrual cycle and then plan when to have sexual intercourse in order to achieve or prevent pregnancy.

## Objectives

- To inform the client about fertility awareness-based methods
- To assist the client to use fertility awareness-based methods
- To discuss the limitations of fertility awareness-based methods

## Types of fertility-awareness based methods

- Basal body temperature (BBT) method
- Calendar/rhythm method
- Cervical mucus method (CMM) or Billings method
- Sympto-thermal method (STM)
- Lactational amenorrhea method (LAM)
- Coitus interrupts (withdrawal method)
- Periodic Abstinence

## Specific counselling issues

### **Advantages of fertility awareness-based methods**

- They enable male involvement in family planning
- No physical side effects
- No effect on breastfeeding or breast milk
- They are safe
- They are helpful for planning or preventing pregnancy
- They are acceptable to many religious groups that oppose conventional methods
- They encourage couples to communicate about family planning and sexuality
- They educate people about women's fertility cycles

### **Disadvantages of fertility awareness-based methods**

- They require high motivation for success
- They require partner cooperation
- They limit sexual spontaneity
- They are not suitable for women with irregular menses
- They may require a lot of practice in order to use correctly
- They offer no protection against HIV/AIDS, STIs
- They are difficult to use after childbirth until menstrual cycle becomes regular again
- Fever, vaginal infection and bleeding may affect their effectiveness

### **When can fertility awareness-based methods be used?**

- When a client's choice is influenced by religious or other personal reasons
- When other methods are contraindicated
- When medical care is inaccessible
- When an inexpensive method is required



## **When can fertility awareness-based methods not be used?**

Fertility awareness-based methods cannot be used if:

- there is no knowledgeable instructor to teach the client
- client is not motivated
- client is not comfortable touching her genitals
- client cannot understand how to use the methods
- client's menses are irregular (for calendar method)
- there is alteration of cervical mucus, e.g. infections
- immediate post-partum or post-abortion
- partner does not cooperate

## **Equipment and materials**

- Basal body thermometer
- Temperature chart
- Calendar
- Fertility regulation calculator

## **Procedure**

### **Client preparation**

- Obtain client history

## **Instructions to client**

### **Basal body temperature method**

Instruct client as follows:

- Take body temperature in the morning before getting out of bed and before eating or drinking anything or putting anything in the mouth
- Take body temperature at the same time every morning, in the same way, either orally, rectally or vaginally
  - Orally for 5 minutes
  - Vaginally for 3 minutes
  - Rectally for 2 minutes

- Record the temperature reading at the level the mercury stops
- If the mercury stops in-between two readings take the lower reading as your body temperature
- Record the temperature reading on a temperature chart and repeat for 3–6 consecutive months to determine the pattern of temperature rise
- Abstain from sexual intercourse from the first day of your period until after the third consecutive day of rise of body temperature by 0.2° to 0.5° C
- Do not use this method if you are breastfeeding because the body temperature may not rise during this period
- Request the client to repeat the instructions

### *Effectiveness*

Basal body temperature method is 99% effective with perfect use.

### **Calendar/rhythm method**

Instruct client as follows:

- Record the number of days in each menstrual cycle for 6–12 months. The first day of monthly bleeding is always counted as day 1
- Determine the beginning of the fertile period by subtracting 18 days from the length of the shortest recorded cycle
- Determine the end of the fertile period by subtracting 11 days from the length of the longest recorded cycle
- If your longest period is 31 days and the shortest is 23 days, your fertile period is from the fifth to the twentieth day of your cycle, i.e. 16 days
- Abstain from sexual intercourse during this period every month

- If your period is irregular do not use this method of contraception, use spermicides or other barrier methods as well
- Request client to repeat instruction

### *Effectiveness*

Calendar/rhythm method is 91% effective with perfect use.

### **Cervical mucus (Billings) method**

Explain the following to the client:

Billings's method is based on changes that take place in the quantity and quality of the cervical mucus during the menstrual cycle. Prior to ovulation the mucus is thick, but at ovulation it becomes thin, clear, plenty and slippery. It easily stretches out between the fingers like egg white. After ovulation, it becomes thick again and does not flow.

### *Instructions to client*

- Feel the vagina daily for mucus
- Record findings daily on appropriate chart
- Have sexual intercourse during the 'dry' days, when no mucus appears
- Abstain from intercourse once mucus appears and until four days after mucus has ceased to be felt
- Do not douche, as this alters the nature of the cervical mucus
- Abstain from intercourse whenever there is inter-menstrual bleeding
- Abstain on alternate days, during the learning phase, prior to onset of the feeling or observation of mucus. This is to reduce the confusion that may arise as a result of the presence of seminal fluid.

### *Effectiveness*

Cervical mucus (Billings) method is 97% effective with perfect use.

### **Sympto-thermal method**

This is a combination of the basal body temperature (BBT) and cervical mucus methods to determine time of ovulation. Other ovulation-associated signs and symptoms such as breast tenderness, feeling of bloatedness, mid-cycle pain, and vaginal spotting are also used in this method.

### *Instructions to client*

Ask the client to avoid sexual intercourse between the first day of monthly bleeding and either the fourth day after mucus has ceased to be felt or the third full day after the rise in BBT, whichever comes first.

### *Effectiveness*

Sympto-thermal method has 98% effectiveness with perfect use.

### **Cycle beads method**

Also called a standard day method. The couple uses cycle beads, a colour-coded string of beads that indicates fertile and non-fertile days of a cycle, as a memory aid.



*Figure 4.1: The cycle beads*

### *Effectiveness*

Cycle beads method is 95% effective with perfect use.

### **Lactational amenorrhea (LAM) method**

Exclusive breastfeeding can be used as a method of contraception because it causes lactational amenorrhea and suppresses ovulation. For the method to be effective, a client must be informed adequately as follows:

- Be sure that the client is willing to use LAM as her contraceptive method
- Explain how LAM works to prevent pregnancy
- Explain other available methods
- Ask her questions about her past and present breastfeeding practice
- Ask the client the following questions (and help her choose another method of family planning if she answer “yes” to any of them):
  - Has the client had a menstrual period since the baby’s birth?
  - Is the baby more than six months old?
  - Does the baby sleep all through the night?
  - Does the baby breastfeed less than eight times a day?
  - Has the baby started taking any other drink or food?
  - If the answer to all questions is No, client may use LAM as a contraceptive method
  - Find out how much client knows about the rules for using LAM as a contraceptive method

### *Instructions to client*

Instruct client as follows:

- Breastfeed exclusively for the first six months
- Breastfeed as often as the child demands

- Refrain from giving a pacifier (dummy)
- Allow baby to breastfeed for a long time each time (at least 15 minutes)
- Breastfeed both in the day (at least eight times, not more than 4 hours apart) and during the night (at least twice, not more than 6 hours apart from other feedings)
- Give no other food, drink or water before six months of age
- Use another method of contraception if for any reason the breast milk begins to fail or breastfeeding is interrupted or irregular, or if menses return.
- Return to the clinic if breastfeeding pattern changes or menses resumes or baby reaches six months of age (another method will be needed; counsel and provide accordingly)

### *Effectiveness*

With common (typical) use, this method is 98% effective and more than 99% effective with correct (perfect) use in the first six months after childbirth.

*Note:* Lactational amenorrhea method can be effective for women who remain amenorrheic and whose infants are less than six months. After six months, effectiveness is not certain.

### **Coitus interruptus**

Coitus interruptus (withdrawal method) is the withdrawal of the penis from the vagina just before ejaculation.

### *Instructions to client*

Instruct the client as follows:

- Wipe off any fluid at the tip of the penis before intercourse (pre-sexual emissions may contain sperm)
- Withdraw the penis from the vagina when ejaculation is about to occur and make sure ejaculation occurs away from the entrance to the vagina

- In case of an accident (failure to withdraw completely before ejaculation has taken place), use a quick acting spermicide such as foaming tablet or jelly immediately, and emergency contraceptive within 120 hours, the sooner the better.

### *Effectiveness*

With common use, 27 pregnancies per 100 women can occur over a year. Failure rate with perfect use is 4 pregnancies per 100 women over a year.

### *Note*

- Do not use this method if there is going to be repeated acts of intercourse
- Do not use this method if your partner is not in full control of ejaculation

### **Abstinence**

This means totally avoiding sexual intercourse.

- Adolescents/youths are encouraged to adopt this method
- Abstinence is morally and culturally acceptable
- It is 100% effective in preventing pregnancy, STIs, HIV and AIDS
- It bestows on young people a sense of self-worth

# Barrier methods of contraception

## Description

Barrier methods prevent the spermatozoa from entering the womb either by chemical action, e.g. spermicides, or mechanical obstruction, e.g. condoms and diaphragms.

## Objectives

- To provide the client with information on available barrier methods
- To assist client in choosing an appropriate barrier method
- To assist client in effectively using the chosen method

## Types of barrier methods

There are two common barrier methods:

1. Chemical methods: prevent the spermatozoa from entering the womb by chemical action, e.g. spermicides
2. Mechanical methods: keep sperms from entering the womb by physical obstruction, e.g. condoms and diaphragms

### Chemical barrier methods

#### ***Spermicides***

Spermicides are chemicals placed in the vagina to immobilize or destroy sperms. They can be used alone or in combination with mechanical barriers such as condoms and diaphragms.

Spermicides are available in the form of:

- creams
- jellies



- aerosol foam
- vaginal foaming tablets
- vaginal suppositories
- vaginal film

### *Specific counselling issues*

#### *Advantages*

- No prescription is required to use spermicides
- Spermicides can be used ahead of intercourse to avoid interruption
- Spermicides have very few side effects
- They are used only when needed
- They have no effect on breast milk
- They do not produce any systemic effects
- They can be provided by non-medical personnel
- Some clients find them convenient to use

#### *Disadvantages*

- They are less effective than any other method of contraception, even when used perfectly.
- Spermicides are not acceptable to those who are opposed to touching their genitalia
- They may produce burning sensation in the client or partner
- Sometimes may lead to urinary tract infection (if used 2 or more times a day)
- They can be difficult to hide from the partner
- They can be messy
- Some spermicides may melt in hot weather
- They may interrupt sex if not inserted beforehand
- They may irritate the client or partner

### *Women who can use spermicides*

Spermicides can be considered by women who:

- do not want to use systemic or other forms of contraceptives
- cannot use other methods because of non-suitability
- have intercourse infrequently
- need to enhance the effectiveness of the diaphragm
- are afraid that other methods may interfere with successful lactation
- require a back-up (as in missed pills or failed withdrawal)
- cannot access medical personnel to initiate other clinical methods

### *Women who cannot use spermicides*

Spermicides are not indicated for women who:

- allergic to the active ingredients in spermicides
- have cervical or vaginal lesions
- have high risk for HIV or have HIV/AIDS

*Note:* Repeated and high dose use of nonoxynol-9 (active ingredient in spermicides) is associated with the risk of genital lesions, which can increase the risk of acquiring HIV.

### *Equipment and materials*

- Spermicides (suppositories, tablets, aerosol foam)
- Appropriate instruction leaflets

### *Procedure*

#### *Client preparation*

- Instruct client about the use of spermicides

#### *Instructions to client on use of spermicide*

Emphasize the following to the client:

- Use method with each act of intercourse
- Use indicated amount of spermicides
- Place spermicide high in the vagina to cover cervical os
- Read and follow instructions for specific methods regarding:
  - time required after placement prior to intercourse
  - duration of effectiveness
- Douching is not recommended, but if done, should be delayed for at least 6 hours after intercourse

### *Effectiveness*

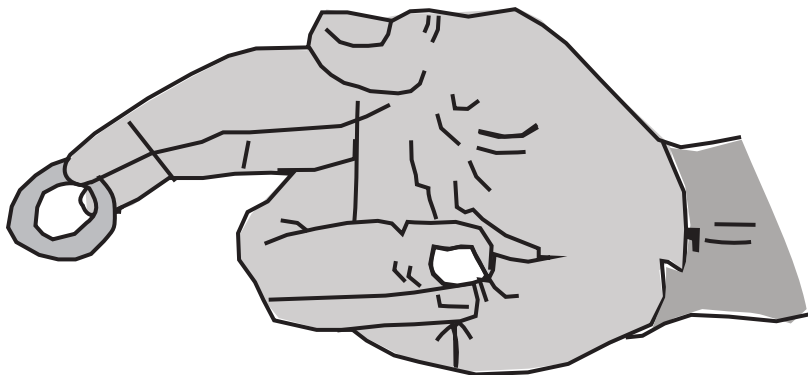
With common use, there could be 29 pregnancies per 100 women using spermicides over the first year. With perfect use, the failure rate is 18 pregnancies per 100 women in one year.

### **Aerosol foam**

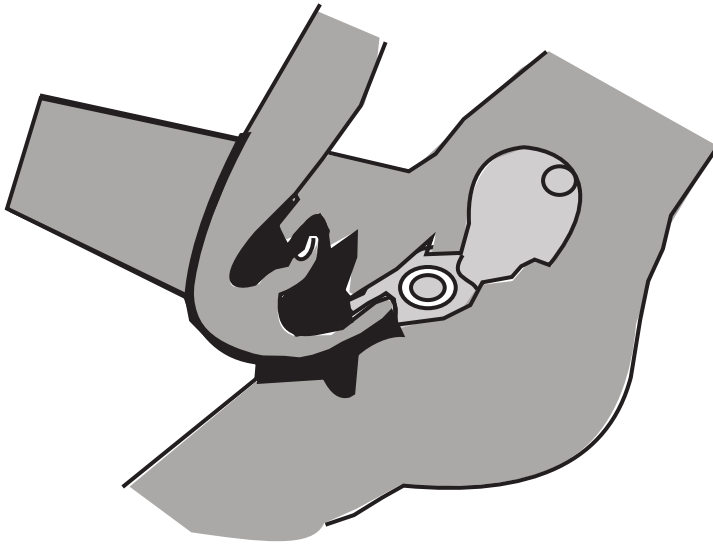
- Use the aerosol foam for every act of intercourse
- Where applicator is pre-loaded, insert the applicator deep into the vagina as far as possible. Withdraw it slightly, and then depress plunger to deposit the foam
- If the foam is in a separate container, shake the can vigorously (about 10 times) and then fill the applicator to the recommended mark as indicated on the package
- Insert the foam applicator as deeply as possible into the vagina and depress the plunger to deposit the foam in the posterior fornix and over the cervix (Figure 18)
- Remove the applicator carefully and wash it for re-use
- Use additional full application of foam before each subsequent act of intercourse
- To clean applicator, pull plunger from barrel and wash with soap and warm (not hot) water

### ***Foaming tablets and vaginal suppositories***

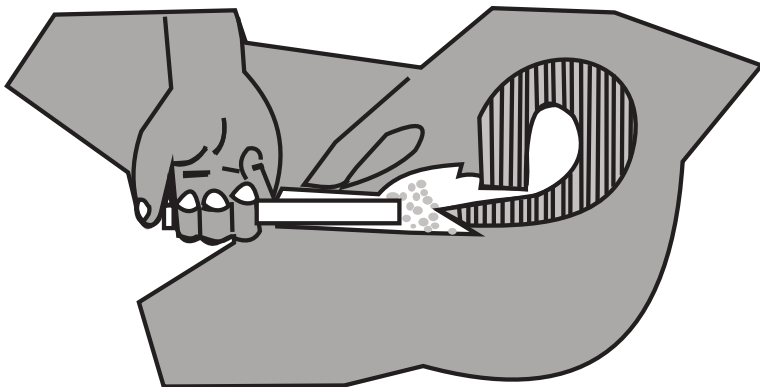
- Use the tablets or suppositories and foam for every act of intercourse
- Take foaming tablet or suppository between the index and middle finger
- Part the labia with the fingers of the other hand and insert the fingers holding the tablet/suppository into the vagina
- Withdraw the middle finger and with the index finger push the tablet/suppository deep into the vagina and up to the top of the vagina (Figures 5.1–5.4)
- Wait for 5–10 minutes for the tablet and 10–20 minutes for suppository) to dissolve before commencing intercourse
- If intercourse is to be repeated, insert another tablet/suppository
- Intercourse can then take place immediately after additional insertion



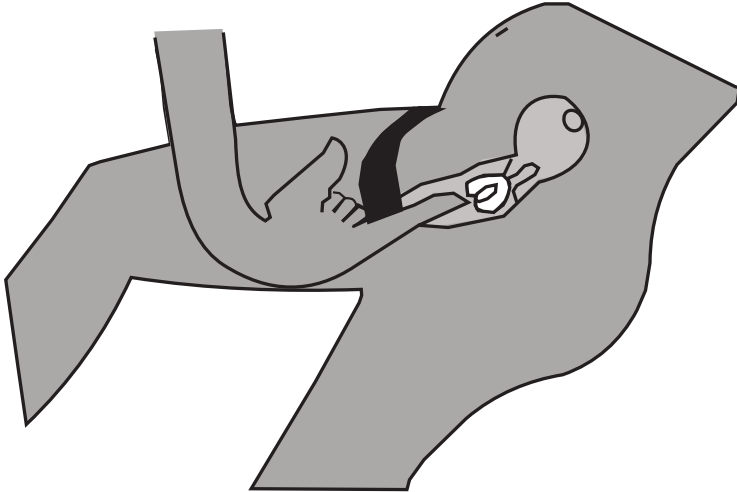
*Figure 5.1: How to use foaming tablet and vaginal suppositories I*  
(To insert, hold a tablet/suppository between the index and the middle finger)



*Figure 5.2: How to use foaming tablet and vaginal suppositories II*  
(Insert first two fingers into the vagina and then withdraw the middle finger)



*Figure 5.3: How to use foaming tablet/jelly/cream*  
(Correct placement of foaming tablet or jelly deep in the vagina)



*Figure 5.4: How to use foaming tablets and vaginal suppositories*  
(Complete the insertion by inserting the index finger deep into the vagina until the tablet/suppository is pushed on to the cervix. Wait for 5–10 minutes for the tablet and 10–20 minutes for the suppository before intercourse.)

### ***Vaginal creams and jellies***

These are commonly used in combination with diaphragms or condoms. When they are used as sole contraceptive, instruct client as follows:

- Screw applicator onto the can containing jelly or cream with the plunger pulled right up
- Squeeze cream/jelly into the applicator until the barrel of applicator is filled
- Detach applicator from the can
- Insert applicator into vagina (as for aerosol foam) and depress the plunger to deposit the cream/jelly into the posterior fornix
- Commence sexual intercourse almost immediately as the jelly/cream disperses quickly

- Use additional applicator of jelly/cream before each subsequent act of intercourse
- Withdraw the applicator carefully
- Clean and wash applicator and plunger as instructed under foam

### *Post-prescription instructions*

Ask client to return to the clinic for re-supply of spermicides and/or when she has any problems with the method.

## **Mechanical barrier methods**

### ***The diaphragm***

The diaphragm is a dome-shaped rubber cup with a flexible rim. It is inserted into the vagina before intercourse so that the posterior part of the rim rests in the posterior fornix and the anterior part of the rim fits snugly behind the pubic bone. The dome of the diaphragm covers the cervix. It is best used with a spermicidal cream, which is poured inside the dome so that it is in contact with the cervix when the diaphragm is in place.

### *Effectiveness*

With common use, about 16 pregnancies occur per 100 women using the diaphragm with spermicide over the first year. Failure rate is 6% with perfect use.

### *Types*

- Diaphragms come in different sizes (diameters from 50 mm to 105 mm). To select a right size, it should be fitted by trained provider.

### *Specific counselling issues*

### *Advantages*

- Diaphragms can be worn by the client without discomfort
- They protect to some degree against some sexually

transmitted diseases, but should not be relied on for STI prevention

- They may be fitted at any time (post-partum mothers must wait for 6 weeks after delivery or mid-trimester abortion)
- They have no systemic effect
- They can be inserted up to 6 hours before sex to avoid interruption
- They are controlled by the woman

### *Disadvantages*

- Diaphragms are not readily available in Nigeria
- They require pelvic examination
- They must be fitted by a provider
- They may be expensive for some users
- The user must remember to insert the diaphragm before intercourse and keep in place for at least 6 hours after sex (but not more than 24 hours)
- Diaphragms require special care and storage
- They can cause urinary tract infection
- A different size of diaphragm may be required after childbirth or if woman gains weight (more than 4 kilogram)
- They can be damaged by excessive use or poor storage
- Diaphragms are unsuitable until uterine involution is complete after delivery

### *Women who can use the diaphragm*

The diaphragm may be used by women who:

- Choose to use it as their preferred method of contraception and have no conditions which may preclude safe diaphragm use
- have infrequent intercourse
- require a temporary method (between pregnancies or to delay first pregnancy)



- to whom no other contraceptive method is available or acceptable
- have contraindications for other contraceptives

### *Women who cannot use the diaphragm*

The diaphragm is not advisable for women who:

- have history of allergy or sensitivity to latex rubber or spermicides
- have history of repeated urinary tract infection (cystitis, urethritis)
- have such abnormalities as cystocele, rectocele, uterine prolapse, retroversion of the uterus, vaginal fistula, or septum
- lack privacy for insertion or lack facilities (soap, water) for taking proper care of the diaphragm
- are at high risk of HIV, have HIV infection or AIDS

### *Equipment and materials*

- Couch
- Gloves
- Pelvic model
- Various sizes of fitting rings
- Various sizes of diaphragms
- Spermicidal jelly or cream and applicator
- Bowls of 75% alcohol
- Bowl of disinfectant for used fitting rings
- Boiled cooled water for sterilization

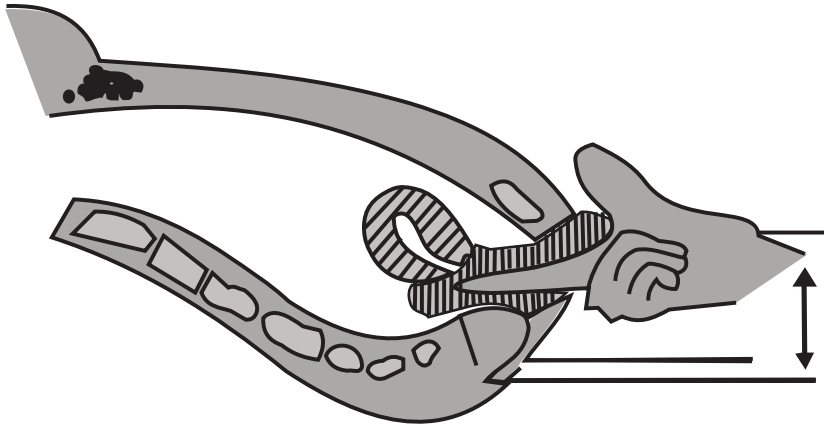
### *Procedure*

#### *Client preparation*

- Show the diaphragm to the client and describe it, pointing out the rim and dome
- Using a pelvic model, insert a diaphragm to demonstrate the relationship with other pelvic organs, especially the cervix, when in place
- Ask the client to empty her bladder

### *Determining the right size of diaphragm*

- Make the client lie down on the couch
- Carry out a vaginal examination to rule out any contraindications
- To determine the size of diaphragm to be fitted:
  - insert the index and middle fingers into the vagina until the posterior fornix is reached see *figure 5.5*



*Figure 5.5: Determining the diaphragm size*

(Proper diameter of diaphragm is determined by measuring the distance from the pubic bone to the posterior vaginal fornix)

- with your right thumb or left finger, mark the point of the index finger now lying under the pubic bone. The distance from this mark to the tip of the middle finger is the diameter of the size of diaphragm suitable for the client. (To be more accurate, ensure that the diameter of the diaphragm to be fitted matches the measurement on the fingers.) see *figure 5.6*
- since the vagina expands during sexual intercourse it is important to add 5mm to the measured size



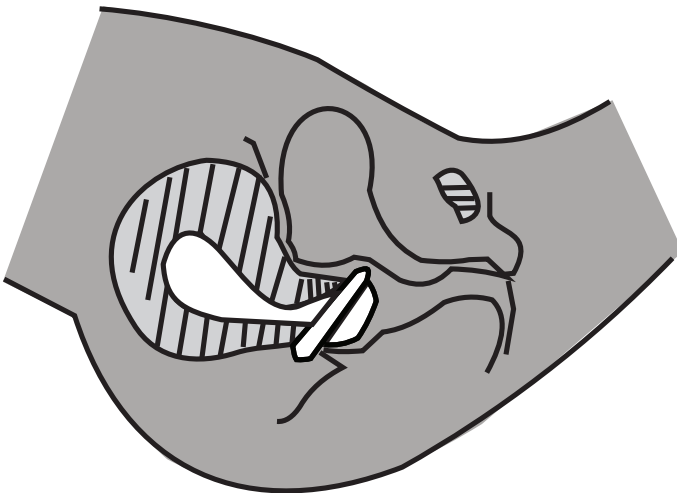
*Figure 5.6: Determining the correct size of the diaphragm*  
(Matching the approximate measurement with the diameter of the diaphragm)

### *Fitting the diaphragm*

With one hand, hold the diaphragm dome down and squeeze 5 ml (one teaspoonful) of spermicidal cream or jelly on both sides.

- Fold the diaphragm by pressing the opposite sides of the rim together
- Part the opening of the vagina with the other hand
- Insert the folded diaphragm into the vaginal canal and push it downward and backward along the posterior wall of the vagina as far as it can go
- Then tuck the front rim of the diaphragm under the pubic bone up unto the roof of the vagina
- Feel round the rim of the diaphragm to ensure that the finger cannot be slipped easily between it and the vaginal wall
- Ensure that the posterior rim lies well behind the cervix, which should be felt through the dome of the diaphragm (Figures 5.7 & 5.8).
- Now ask the client to feel the diaphragm inside her vagina. In particular ask her to feel for the cervix through the diaphragm.

- Ask client if she is aware of the presence of the diaphragm inside her and if there is any discomfort (e.g. pressure on the rectum). Discomfort may mean that diaphragm is too big for her
- Remove the diaphragm by hooking the index finger between the vagina and the anterior rim and pressing downward and outwards
- Ask the client to insert the diaphragm herself, going through all the steps listed above with or without your presence according to client's wish
- After client has fitted the diaphragm, check to be sure that it has been inserted properly
- Ask client to repeat the procedure until you are sure she can fit the diaphragm satisfactorily
- Supply client with diaphragm, spermicide and applicator
- Give follow-up appointment (one week) and ask client to come with the diaphragm fitted from home



*Figure 5.7: Proper placement of the diaphragm*

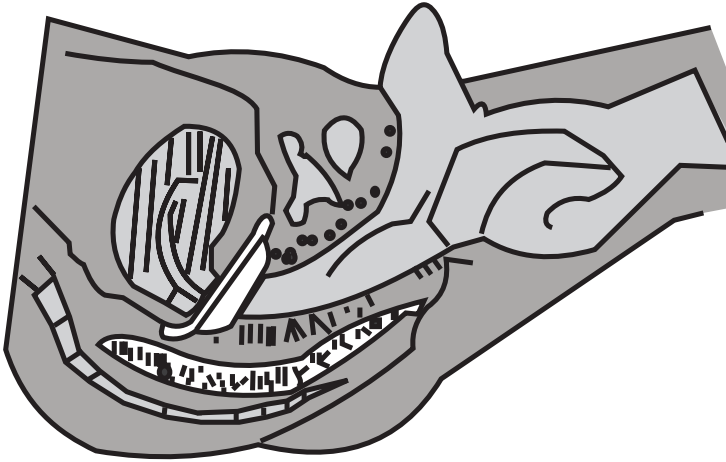


Figure 5.8: Feeling the diaphragm in place

#### *Post-prescription instructions*

Before the client leaves the clinic, give the following instructions clearly:

- Insert the diaphragm before initial act of intercourse
- The diaphragm may be inserted anytime within 5 hours before intercourse (however, if intercourse does not take place within two hours, apply additional spermicides into the vagina without removing the diaphragm)
- Cover the diaphragm with spermicide and place about one teaspoonful in the dome of the diaphragm before insertion
- Always check for proper placement (cervix should be felt at the center of the diaphragm, but the posterior rim should not be felt)
- Leave the diaphragm in place for at least 6 hours after sexual intercourse (do not exceed 24 hours)
- Use additional spermicides with each separate act of intercourse without removing the diaphragm

- After removal, wash diaphragm with clean water and unscented soap, then dry and dust with unscented powder (corn starch is best) and put it back in its container
- Check for hole by filling the diaphragm with water or holding it up against the light
- Always keep diaphragm away from areas of intense heat
- Re-check diaphragm size every year and after delivery, abortion, pelvic operations, or noticeable weight loss or gain
- Do not use any lubricants (like Vaseline or other petroleum product) other than the prescribed spermicide
- Return to the clinic if any problems (e.g. frequent, painful urination), or concerns, or difficulties inserting diaphragm

#### *Follow-up*

- Ask the client what problems she has had since her first visit
- Request the client to insert the diaphragm if not already inserted
- Examine the client to ensure proper placement of the diaphragm
- Ask the client to re-visit the clinic:
  - for re-supply of spermicides
  - whenever she has problems
  - yearly as a routine for:
    - physical examination
    - ensuring proper fit of diaphragm
    - collection of a new diaphragm if indicated routine pap smear

## Managing problems associated with use of the diaphragm

The client should report to the clinic if she has any of the following complaints:

Complaint	Management
Vaginal/ vulval irritation with abnormal vaginal discharge	<p><i>History</i></p> <ul style="list-style-type: none"> <li>• Ask client the quantity, colour, and odour of discharge</li> <li>• Is the discharge thick or watery and foamy?</li> </ul> <p><i>Examination</i></p> <ul style="list-style-type: none"> <li>• Take a high vaginal and cervical swab for microscopy, culture and sensitivity</li> <li>• Treat for any organisms isolated</li> <li>• Advise client on another contraceptive method</li> </ul> <p><i>If discharge is white and thick like pap, the cause is likely to be yeast infection:</i></p> <ul style="list-style-type: none"> <li>• Give cotrimazole (canesten) pessaries to be applied high up in the vagina twice daily for 6 days or Gyno-Trosyd twice daily for 3–4 days</li> <li>• Advise client on how to wash and dry diaphragm before storage</li> <li>• Ask client to return for follow-up in three days and for culture report, if HVS was taken</li> </ul> <p><i>If discharge is watery/frothy, copious and creamy in colour with or without odour, the cause is likely to be Trichomonas vaginitis:</i></p> <ul style="list-style-type: none"> <li>• Give metronidazole (Flagyl) tablets 200 mg tds x 7 days and doxycycline caps 100 mg twice daily for 10 days</li> <li>• Treat partner(s)</li> <li>• Advise client on how to wash and dry diaphragm before storage</li> <li>• Ask client to return for follow-up in three days and for culture report if HVS was taken</li> </ul>

Complaint	Management
Frequent urination and/or burning sensation during urination	<ul style="list-style-type: none"> <li>• Send midstream urine for bacteriological examination and treat</li> <li>• In the absence of laboratory facilities, treat urinary tract infection with: Septrin 960 mg (2 tabs) bd x 5–7 days or Nitrofurantoin</li> <li>• Encourage liberal fluid intake</li> <li>• Review size of diaphragm. In case infection recurs, consider refitting with a smaller diaphragm</li> <li>• Ask client to return for follow-up in two weeks and review the complaints</li> <li>• Encourage to urinate after sexual intercourse</li> </ul>

### **Condoms**

Condoms are mechanical barriers to the passage of sperms between the genital tracts of sexual partners. There are two types – male and female condoms.

#### ***The male condom***

The male condom is a thin latex rubber sheath that is worn over the erect penis before penetration. It acts as a barrier preventing semen from entering the vagina.

#### ***Effectiveness***

With common use, about 15 pregnancies per 100 women whose partners use male condoms over the first year can occur. With perfect use failure rate is 2%.

#### ***Types***

There are three types of male condoms, differing mainly in the material used in making them.

- Condoms made from latex rubber – most common
- Condoms made from natural tissues



- Condoms made from synthetic materials (soft plastic)

### *Specific counselling issues*

#### *Advantages*

- No medical prescription is required
- Condoms are widely available
- They have no systemic side effects
- Condoms (other than natural condoms) protect against some sexually transmitted infections in addition to pregnancy including HIV/AIDS
- They are relatively cheap
- They promote partner participation in family planning
- May promote foreplay in some couples

#### *Disadvantages*

- Condoms may decrease sexual enjoyment for some couples
- A new condom must be used with each act of intercourse
- Condoms may interrupt foreplay
- They deteriorate if not properly stored
- The condom may burst or slide off a flaccid penis during withdrawal
- They require partner cooperation

#### *Men who can use the male condom*

In general, anyone who is not allergic to latex can use the condom, but condoms are particularly useful when:

- sexual intercourse is infrequent
- non-prescription type contraceptive is desired
- a temporary contraceptive method is required between pregnancies or before a first pregnancy
- the male wants to share in the contraceptive responsibility
- no other contraceptive methods are available or acceptable to the couple

- there are contraindications to the use of the IUD and the hormonal contraceptive in the partner on medical grounds
- multiple sexual partners are involved
- used as back-up for some other methods
- protection against STIs/HIV is required

*Men who cannot use the male condom*

Condoms are not useful for men who are:

- severe allergic to latex (rubber): extremely rare
- unable to sustain erection

*Equipment and materials*

- Packet of condoms
- Contraceptive cream or jelly
- Wooden or plastic model of an erect penis
- Instructional pamphlet on use of condoms

*Client preparation*

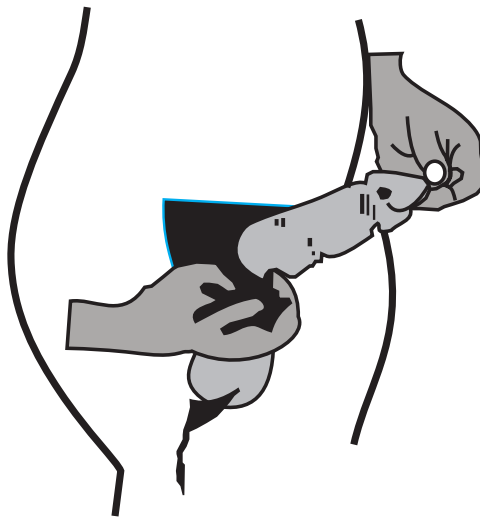
- Demonstrate proper use of the condom
- Carefully open the packet by tearing it at the designated point to avoid damaging the condom
- Do not open with the teeth or sharp fingernails
- Pinch the nipple end as you unroll the condom over a model (wooden/plastic) penis, leaving a small space at the tip if there is no nipple (Figure 5.9)

*Post-prescription instructions*

Instruct the client clearly as follows:

- Condom should be worn over an erect penis
- Always keep a supply of condoms at hand, preferably in a cool dry place, away from bright light but within easy reach for use at every intercourse
- Do not test a condom by inflating or stretching it
- Handle condoms gently and keep away from sharp objects including fingernails

- Put condoms on before any genital contact
- If necessary, lubricate the outer part of the condom using a contraceptive jelly or any water-soluble lubricant, but do not use Vaseline or other petroleum product as lubricant
- After ejaculation, while the penis is still erect, hold the rim of the condom firmly against the base of the penis during withdrawal
- Remove the condom from the penis, taking care not to spill semen on the vulva
- Discard the used condom in a pit latrine or burn or bury it
- Do not flush condoms down the toilet because it may cause blockage and do not leave them where children can find them
- Use a new condom for every subsequent intercourse
- If you find that the condom is torn after intercourse, the female partner should insert contraceptive foam, jelly or suppository into her vagina immediately. She should obtain emergency contraceptive and use it as soon as possible within 120 hours after intercourse.



*Figure 5.9: Correct placement of the condom*

### *Follow-up*

The client should visit the clinic for re-supply of condoms when necessary.

### **Managing problems associated with condom use**

<b>Complaint</b>	<b>Management</b>
Recurrent irritation of the vagina or penis	<ul style="list-style-type: none"><li>• Suggest trying another brand of condoms</li><li>• Suggest putting extra lubricant to reduce rubbing or using water instead of spermicide (irritation may be due to spermicide and not condom itself)</li><li>• If client is not at risk of STIs, help to choose another method of contraception</li><li>• If client is at risk of STI, suggest using female condoms or plastic male condoms, if available. If not available, encourage continued use of latex condom unless allergy is severe.</li><li>• If allergy is severe, discontinue use of condom and use another method of contraception</li></ul>
Condom breaks during intercourse	<ul style="list-style-type: none"><li>• Return to clinic, consider emergency contraception</li></ul>

### ***The female condom***

The female condom is a sheath of soft polyurethane or latex, which is inserted into the vagina before genital contact. It has two flexible rings – a removable ring at the closed end to aid insertion and a fixed ring at the open end, which sits on the vulva to hold the condom in place.

### ***Effectiveness***

With common use, 21 pregnancies occur per 100 women years and 5 pregnancies per 100 women years with perfect use.



*Figure 5.10: The female condom*

### *Specific counselling issues*

#### *Advantages*

- No medical prescription is required
- Female condom is widely available
- It has no systemic side effects
- It protects against some sexually transmitted infections including HIV/AIDS in addition to pregnancy (dual protection)
- It is relatively cheap
- It promotes partner participation in family planning
- Usage is controlled by the woman and needs only to be used when required

#### *Disadvantages*

- Use may be associated with excessive (unpleasant) noise during intercourse
- The penis needs to be guided to avoid passing outside the outer ring
- Application involves the woman touching her genitals

### *Women who can use the female condom*

Anyone can use the condom if the person is not allergic to latex, but condoms are particularly useful when:

- sexual intercourse is infrequent
- non-prescription contraceptive is desired
- a temporary contraceptive method is required between pregnancies or before a first pregnancy
- no other contraceptive method is available or acceptable to the couple
- there are contraindications to the use of the IUD and the hormonal contraceptive
- client has multiple sexual partners
- used as back-up for some other methods
- protection against STIs/HIV is desired

### *Women who cannot use the female condom*

- Women who have genital prolapse
- Women who have vaginal abnormalities, e.g. septa, atresia/stenosis

### *Equipment and materials*

- Female condom
- Spermicide
- Pelvic model
- Instructional leaflet on female condom

### *Procedure*

Demonstrate proper use of the female condom as follows:

- Condom can be inserted anytime within 8 hours before sex
- Spread the lubricant evenly by rubbing the sides of the condom packet together
- Carefully open the packet by tearing it at the designated point to avoid damaging the condom

- Stand with legs astride or squat or lie down
- Squeeze the inner ring of the condom (at the closed end) between the thumb, index finger and middle finger
- With the other hand, separate the labia
- Insert the squeezed ring into the vagina as far as possible; insert a finger into the condom and push in the rest of the condom with the index or middle finger until the inner ring reaches the end of the vagina
- Gently curve the finger towards the front of the vagina to feel the pubic bone, indicating that the condom has been inserted correctly. About 2 to 3 cm of the condom and larger outer ring remain outside the vagina
- The larger outer ring is smoothed over the vulva to ensure that the penis goes into the shield and not by its side
- The penis does not have to be withdrawn immediately after ejaculation
- To remove the condom, hold onto the outer ring and twist it so that the semen does not spill out
- Gently pull and slide the condom out of the vagina
- Do not re-use the condom

### *Post-prescription Instruction*

Instruct the client clearly as follows:

- Do not test the condom by stretching it
- Put condom in before any genital contact
- Discard each condom after use
- Use a new condom for each act of intercourse
- Throw the condom away in a pit latrine, burn or bury it
- Do not flush the condom down the toilet because it may cause blockage
- Do not leave the condom where children can find and play with it.

# Oral contraceptive pills

## Description

Oral contraceptive pills are synthetic female hormones – oestrogen and progestin – taken in combination or as progestin alone, by women, to prevent pregnancy.

## Objectives

- To educate the client on the benefits, risks and special features of oral contraceptive pills
- To screen clients for eligibility to use oral contraceptive pills
- To instruct the client on correct use of oral contraceptive pills
- To review the situation with the client periodically and ensure continuing correct use
- To respond to the client's concerns about the pills
- To identify and manage side effects arising from the use of pills

## Types of oral contraceptive pills

- Combined oral contraceptives (COCs) contain both oestrogen and progestin:
  - low dose COC (those containing 0.03 mg of oestrogen) are commonly used for ongoing contraception
  - high dose COCs (those containing 0.05) are used mostly for emergency contraception)
- Progestin-only pills (mini pills) (POPs)
- Emergency contraceptive pills (ECPs)



## **Combined pills**

### ***Specific counselling issues***

#### *Advantages*

- Combined pills are highly effective if used correctly
- Very safe for majority of women
- Client can discontinue independently
- Combined pills are suitable for all reproductive age and parity groups
- Use is not related to the time of sexual intercourse
- Combined pills reduce menstrual pain and mid-cycle ovulation pain, where present
- They reduce menstrual flow in heavy bleeders
- They can prevent or decrease iron deficiency anaemia
- They regularize irregular periods
- They offer some protection against cancers of the womb and ovary
- Combined pills enable postponement of period for social reasons
- They reduce the risk of ectopic pregnancy and symptomatic pelvic inflammatory disease (PID)

#### *Disadvantages*

- Combined pills must be taken daily
- They may cause minor, but usually temporary, side effects such as:
  - mild headache
  - nausea
  - spotting
  - weight gain
  - breast tenderness
  - mood changes
- They do not protect against STIs and HIV/AIDS
- They are not recommended for breastfeeding women

- Compliance is difficult for some women
- Serious complications are very rare, but can occur in some women with underlying health conditions

*Note:* The risks should be compared to the risk of pregnancy

### *Effectiveness*

When commonly used, about eight pregnancies occur per 100 women using **combined oral contraceptives over the first year**. When there are no pill-taking mistakes, less than one pregnancy occurs per 100 women using **combined oral contraceptives over the first year (3 per 1,000 women)**.

### *Women who can use combined oral contraceptive pills without restriction (WHO Category 1)*

- Women who are between menarche and less than 18 years
- Nulliparous women
- Women who have puerperal sepsis and post-abortion sepsis
- Women with current and past pelvic inflammatory disease
- Women with increased risk of STIs/HIV or those with current STI, including gonorrhoea and chlamydia infection, or women with vaginitis
- HIV positive women (not on antiretroviral therapy)
- Women who have non-migrainous headache
- Women who have uterine fibroid
- Women with irregular, heavy or prolonged bleeding patterns
- Women with endometrial or ovarian cancer (awaiting treatment)
- Women with chronic hepatitis, or those who are carriers
- Women with mild (compensated) cirrhosis
- Women who take broad-spectrum antibiotics, antifungal or antiparasitic medication

*Women who can generally use combined oral contraceptive pills; some follow up may be needed (WHO Category 2)*

- Women who are 40 years and older
- Women who are breastfeeding after 6 months postpartum
- Women with superficial thrombophlebitis
- Women with migraines without aura who are less than 35 years old
- Women who have cervical cancer (pre-treatment)
- Women with unexplained vaginal bleeding
- Women who are less than 35 years old and smoking
- Women who have non-vascular (uncomplicated) diabetes
- Women with asymptomatic gall-bladder disease or those treated by cholecystectomy
- Obese women
- Women on antiretroviral therapy (unless their ARV regimen contains ritonavir or ritonavir-boosted protease inhibitors)
- Women with systemic lupus erythematosus who are negative for antiphospholipid antibodies
- Women who have liver tumour such as focal nodular hyperplasia

*Use of combined oral contraceptive pills usually not recommended in these women; (WHO Category 3)*

- Women taking certain drugs, anti-tuberculosis drugs (e.g. rifampicin/rifabutin), anticonvulsants (e.g. phenytoin, carbamazepine or lamotrigine)
- Breastfeeding women from 6 weeks to 6 months postpartum
- Non-breastfeeding women within the first 21 days postpartum
- Women who are smoking <15 cigarettes/day and are above 35 years
- Women who have blood pressure of 140–159 mmHg systolic and 90–99 mmHg diastolic

- Women who had breast cancer in the past and no evidence of current disease for five years
- Women with migraines without aura who are more than 35 years old
- Women current or medically treated gall-bladder disease
- Women who take ritonavir or ritonavir-boosted protease inhibitors as part of their ARV regimen
- Women with undiagnosed vaginal bleeding (until evaluated and diagnosed)

*Women who should not use combined oral contraceptives pills (WHO Category 4)*

- Women whose blood pressure is at or above 160 mmHg systolic and at or above 100 mmHg diastolic
- Women with history of or current deep vein thrombosis (DVT) or pulmonary embolism (PE), even when established on anticoagulant therapy
- Women who are smoking more than 15 cigarettes/day and are 35 years or older
- Women who are having major surgery with prolonged immobilization
- Women with stroke or ischemic heart disease, both history or current
- Women who have migraine with aura at any age
- Women who have any liver tumour other than focal nodular hyperplasia
- Women with acute/flare hepatitis
- Breastfeeding women who are within 6 weeks postpartum
- Women with current breast cancer
- Women with systemic lupus erythematosus who have positive or unknown antiphospholipid antibodies
- Women with complicated diabetes or diabetes of more than 20 years duration

### *Equipment and materials*

- Combined pills
- Condom
- Clinic card
- Equipment for physical examination
- Visual aids

### *Procedure*

#### *When to initiate pills*

Pills can be initiated anytime during the menstrual cycle, when provider is reasonably sure that a woman is not pregnant.

#### *Client's preparation*

- Greet client and offer a seat
- Make her comfortable and relaxed
- Find out what she already knows about combined pills and fill any gaps in her knowledge
- Provide adequate information on the pills including advantages, disadvantages and side effects
- Take a thorough history of the client and screen the client for eligibility using the **screening checklist for initiation of COCs**.
- Physical and pelvic examination is not necessary for safe initiation of COCs but should be offered in clinical settings as part of good preventive healthcare.
- Give new clients one cycle of pills and a one month appointment. If she is a revisit client, give her three cycles of pills and an appointment to return in three months.

#### *Instructions for using combined oral contraceptive pills*

Instruct the client to:

- take one tablet preferably around the same time every day whether she is likely to have sexual intercourse or not

- if she starts her first pack of pills within the first five days of menstrual cycle, no back-up method needed.
- if it is more than five days, client should use back-up method, such as condom, for seven days.

Explain to the client that there are two types of pill packs – those containing 28 pills and those containing 21 pills.

For 28-pills packs, explain that:

- the first 21 of the 28-tablet pack are the active tablets and they have the same colour. The last 7 tablets have a different colour and are the non-active tablets (contain no hormones)
- she should start with the 21 same colour tablets and continue with the 7 differently coloured ones
- she should begin the next pack the day after taking the last tablet of the present pack, whether menses has occurred or not. There should be no break between packs
- she should always start a new pack with the group of 21 same colour tablets
- she should visit the clinic for refill whenever she is on her last pack of pills before she finished taking the last 7 same colour tablets

For the 21-tablet pack, explain to the client that:

- all the tablets are of the same type and colour
- she should wait for seven days after taking the last tablet in the present pack before starting to use a new pack, whether menses has occurred or not

*What can a woman do if she misses the combined oral contraceptive?*

1. If she misses one or two active (hormonal) pills or if she starts a pack one or two days late:

- she should take an active (hormonal) contraceptive as soon as possible and continue taking pills as usual (that means she may take 2 pills on the same day or at the same time)
  - she does not need any additional contraceptive
2. If she misses three or more active (hormonal) pills or if she starts a pack three or more days late:
- she should take an active (hormonal) contraceptive as soon as possible and continue taking the pills as usual (that means she may take 2 pills on the same day or at the same time)
  - she should also use condoms or abstain from sex until she has taken active (hormonal) pills for seven days in a row
  - If she misses pills in the third week, she should finish the active (hormonal) pills in her current pack, throw away 7 inactive (brown) pills and start a new pack the next day. She should also use a backup method (condom) for the next 7 days.

If she missed three or more active pills at any time or started a new pack 3 or more days late **and** she had sex in the past 5 days, she may consider using emergency contraception

*Note:* If the client thinks it would be hard for her to remember to take contraceptive pills on time, or if she keeps missing pills, the provider should encourage her to consider changing to another method.

*Important issues that the client should remember*

- Combined oral contraceptive does not protect against STIs and HIV/AIDS
- Use condoms in addition to pills for protection against STIs and HIV/AIDS

- Keep a back-up method, like condom and vaginal spermicides
- If the client is seeing a doctor for any health problem she should inform the health provider that she is using combined oral contraceptive
- How and where to get supplies
- The importance of keeping appointments
- Conduct regular self breast examination
- Report to the clinic
  - if there are questions or concerns
  - on the scheduled date
  - 4–6 weeks before and after major operations
- Report immediately to the clinic if she experiences any of the following:

**A** - Abdominal pain (severe)  
**C** - Chest pain (severe)  
**H** - Headache (severe)  
**E** - Eye problems, blurring of vision  
**S** - Severe calf pain

*Note:* Anti-TB agents (Rifampicin, rifabutin), anti-convulsants (Phenytoin, Phenobarbitone, Primidone, Carbamazepine) and antiretroviral agents (ritonavir) reduce the efficacy of oral contraceptives. Rifampicin also causes possible breakthrough bleeding. Women who take these medications should not use COCs.

### *Follow-up*

At one month after the initial pill prescription:

- Check blood pressure and weight
- Ask of any early side effects, respond to them and re-assure her
- Rehearse the method of taking pills with client by asking her to tell you how she should take the pill and what to do if she misses the pill(s)



- Give six months supply if client shows the ability to use pills correctly
- Instruct the client to come for re-supply before the last pack finishes
- If you still have doubts about her ability to take pills properly, see her monthly until you are satisfied or consider counselling about another method
- Then see her every three months for re-supply and once a year for general check-up
- Tell her to return to the clinic without appointment any time she has any problems or doubts
- Encourage her to carry out self breast examination monthly

*Note:* If the client cannot revisit the original clinic she should go to the nearest family planning clinic.

At six months and one year visits:

- Obtain information on the use of the pill
- Check blood pressure and weight
- Ask about side effects and danger signals and manage appropriately
- Supply pills (six packs every six months)
- Give a return appointment for six months
- Encourage client to do a pap smear at the appropriate time

## Management of problems associated with combined oral contraceptives

Irregular bleeding or spotting	
History and examination	<p>Ask the client:</p> <ul style="list-style-type: none"> <li>• when she started taking the pills</li> <li>• whether spotting occurred after intercourse</li> <li>• if spotting is associated with pelvic pain during intercourse</li> <li>• date of last menstrual period.</li> <li>• if she had diarrhoea or vomiting?</li> <li>• if she has been taking any other medication, such as anti-TB or anti-seizures medication</li> </ul> <p><i>Physical examination (only if underlying condition is suspected)</i></p> <ul style="list-style-type: none"> <li>• Do pelvic examination (including speculum examination) if you suspect intrauterine or ectopic pregnancy, pelvic infection, cervical abnormalities or inflammation)</li> </ul>
If bleeding/spotting occurs in the first three months	<ul style="list-style-type: none"> <li>• Re-assure the client that spotting should decrease or stop after the first three months</li> <li>• Ask her to continue using her pills on schedule</li> <li>• For short-term relief, try ibuprofen (800 mg 3 times a day) at a time when breakthrough bleeding starts.</li> <li>• Give follow-up appointment to re-assess spotting</li> </ul>
If history suggests incorrect pill taking and the client is not pregnant	<ul style="list-style-type: none"> <li>• Re-instruct client on correct use of pills</li> <li>• Have client repeat instructions to you</li> <li>• Provide her with emergency contraceptive pills and explain how to use them</li> <li>• Give the client a return appointment for one month</li> </ul>

### Irregular bleeding or spotting

Bleeding/spotting is due to infection	<ul style="list-style-type: none"> <li>• Manage according to the procedure explained in chapter 12 on STI</li> </ul>
Bleeding/spotting is due to suspected ectopic pregnancy	<ul style="list-style-type: none"> <li>• Refer to hospital immediately</li> </ul>
Bleeding/spotting is due to intrauterine pregnancy	<ul style="list-style-type: none"> <li>• Stop pills</li> <li>• Counsel the client about the finding</li> <li>• Refer to antenatal clinic (ANC)</li> </ul>
Bleeding/spotting is due to initiation of treatment with rifampicin, anticonvulsants or ritonavir	<ul style="list-style-type: none"> <li>• if she will be taking these medications long-term, help her choose another method of contraception</li> <li>• if using these medications short-term, advise to use condoms along with COCs until she finishes treatment</li> </ul>
Bleeding/spotting occurs after diarrhoea/vomiting	<ul style="list-style-type: none"> <li>• Instruct client to continue taking the pills as usual and use a barrier for the next seven days after vomiting/diarrhoea stops</li> </ul>
Bleeding/spotting occurs mainly after intercourse	<ul style="list-style-type: none"> <li>• Do speculum examination to exclude conditions like cervicitis or cervical erosion and cancer</li> <li>• Do a pap smear if possible</li> <li>• Refer to a specialist if needed</li> </ul>

<b>Nausea and/or vomiting</b>	
History and examination	<p>Ask the client:</p> <ul style="list-style-type: none"> <li>• If she takes her pills every day</li> <li>• if she is taking the pills on empty stomach</li> <li>• if nausea comes after she starts a new pill pack</li> <li>• if she has any symptoms of pregnancy</li> <li>• date of last menstrual period (LMP)</li> <li>• dietary intake of fatty gaseous foods</li> </ul> <p><i>Physical examination</i></p> <ul style="list-style-type: none"> <li>• Take vital signs and record</li> </ul>
If she takes pills every day, reassure that she is most likely not pregnant	<ul style="list-style-type: none"> <li>• Suggest taking COCs at bed time or with food</li> <li>• Consider extended use of COCs (taking 12 weeks of active hormonal pills without a break, followed by one week of non-hormonal pills (or no pills))</li> </ul>
If nausea is due to pregnancy	<ul style="list-style-type: none"> <li>• Stop the pill</li> <li>• Counsel</li> <li>• Refer for antenatal care</li> </ul>
<b>Excessive weight gain</b>	
History and examination	<p><i>History</i></p> <p>Ask the client if:</p> <ul style="list-style-type: none"> <li>• weight gain began after she started pills</li> <li>• there is increase in appetite</li> <li>• weight gain is cyclical or recurrent</li> <li>• symptoms of pregnancy are present</li> </ul> <p><i>Physical examination</i></p> <ul style="list-style-type: none"> <li>• Take and record vital signs including weight</li> </ul>
If weight gain is due to dietary habits	<ul style="list-style-type: none"> <li>• Counsel client about healthy diet</li> <li>• Advise on regular physical exercise</li> </ul>

<b>Excessive weight gain</b>	
If weight gain began after COC initiation	<ul style="list-style-type: none"> <li>• Advice on diet and exercise</li> <li>• If weight gain is unacceptable to client, help her to choose another (non-hormonal) method of contraception</li> </ul>
<b>Mood swings/depression</b>	
History and examination	<p>Ask the client:</p> <ul style="list-style-type: none"> <li>• if the onset of mood swings was before or after starting the pills</li> <li>• if her social conditions have changed, e.g. marriage, job, finances</li> <li>• about the severity of mood swings or depression</li> <li>• comparison with feelings before starting pills (if there was a history of depression)</li> </ul>
If mood swings/ depression appears to be pill related	<ul style="list-style-type: none"> <li>• Some women have mood swings/depression during the hormone-free week. Consider extended use of COCs (taking 12 weeks of active hormonal pills without a break, followed by one week of non-hormonal pills (or no pills))</li> <li>• If mood swings/depression are unacceptable, help client to choose another method (non-hormonal)</li> <li>• If depression is serious, refer for care</li> </ul>
If depression seems to be related to social problems	<ul style="list-style-type: none"> <li>• Encourage her to speak openly and confide in a trusted person</li> <li>• Refer to a social worker</li> <li>• If depression is serious, refer to the specialist for treatment</li> </ul>

<b>Headaches</b>	
History and examination	Ask the client if: <ul style="list-style-type: none"> <li>• it occurred before the pills, e.g. due to social, financial or other stress conditions</li> <li>• it is migraine-type headaches (e.g. throbbing, sudden onset preceded by visual disturbance)</li> </ul>
If it is ordinary headache	<ul style="list-style-type: none"> <li>• Counsel that headaches may occur in women using COCs. They often diminish or go away after a few months of COC use</li> <li>• Offer painkillers</li> </ul>
If migraine	<ul style="list-style-type: none"> <li>• Stop the pill</li> <li>• Help to choose another method (non-hormonal)</li> <li>• Refer to the specialist as appropriate</li> </ul>
If headaches are due to high blood pressure is (140/90 mmHg or above)	<ul style="list-style-type: none"> <li>• Take several measurements.</li> <li>• If consistently high, stop the pill</li> <li>• Counsel for other contraceptive method as appropriate</li> <li>• Refer to a specialist as needed</li> </ul>
<b>Loss of libido (reduced sexual urge)</b>	
History and examination	Ask the client if: <ul style="list-style-type: none"> <li>• there is painful coitus, and/or dry vagina during intercourse</li> <li>• there are marital or other social problems</li> <li>• loss of libido started before or after taking the pills</li> </ul> <p><i>Physical examination</i></p> <ul style="list-style-type: none"> <li>• Perform pelvic examination if infection or injury are suspected</li> </ul>
If no cause is found	<ul style="list-style-type: none"> <li>• Suggest additional use of water-based lubricants such as KY jelly to reduce vaginal dryness</li> </ul>

<b>Loss of libido (reduced sexual urge)</b>	
If infection or injury are suspected	<ul style="list-style-type: none"> <li>• Treat or refer as appropriate (for STIs see chapter 12)</li> </ul>
If problem is related to social stress	<ul style="list-style-type: none"> <li>• Counsel as appropriate and/or refer to social worker</li> </ul>
<b>Breast tenderness</b>	
History and examination	<p>Ask the client if:</p> <ul style="list-style-type: none"> <li>• symptoms of pregnancy are present</li> <li>• symptoms started with pill use</li> <li>• there is any breast lump or nipple discharge</li> </ul> <p>Physical examination</p> <ul style="list-style-type: none"> <li>• Do breast examination to exclude lump, discharge or infection</li> <li>• Do pelvic examination if history suggests pregnancy</li> </ul>
If no abnormalities	<ul style="list-style-type: none"> <li>• Counsel that breast tenderness are not uncommon in COC users</li> <li>• Advise client to wear firm supportive brassiere and use analgesics</li> </ul>
If any abnormalities are found	<ul style="list-style-type: none"> <li>• Refer to a specialist</li> </ul>
If due to pregnancy	<ul style="list-style-type: none"> <li>• Stop the pill and refer to ANC</li> </ul>

## Acne (pimples)

<p>History and examination</p>	<p>Ask the client:</p> <ul style="list-style-type: none"> <li>• if problem started since taking the pills (if acne coincides with COCs initiation, it is most likely a side effect of the pills)</li> <li>• about her dietary habits, particularly as regards fats, fizzy drinks, sweets</li> <li>• how she cares for her skin and if she notices any cyclic outbreak of acne</li> </ul> <p><i>Physical examination</i></p> <ul style="list-style-type: none"> <li>• Carry out physical examination and observe hair distribution (to exclude ovarian tumours)</li> <li>• Observe location, size, numbers, and colour of lesions</li> <li>• Perform pelvic examination or ultrasound to if an ovarian tumour is suspected.</li> </ul>
<p>If acne developed or got worse since COC initiation</p>	<ul style="list-style-type: none"> <li>• Try different formulation of low-dose COCs</li> <li>• Advise client to cut down on fatty foods</li> <li>• Use a skin cleanser and astringents, e.g. lime</li> <li>• If acne persists and client is concerned about it, help her choose another method</li> </ul>
<h3 style="margin: 0;">Warning signs of complications</h3>	
<p>If the following danger signals occur:</p> <ul style="list-style-type: none"> <li>• Abdominal pain (severe)</li> <li>• Chest pain (severe), cough, shortness of breath,</li> </ul>	<ul style="list-style-type: none"> <li>• Stop pills</li> <li>• Refer to a specialist urgently</li> </ul>



### Warning signs of complications

- coughing up blood
- Headaches (severe), dizziness, weakness of limb, numbness
- Eye problem (blurred vision, loss of vision, flashes of light)
- Severe leg pain (calf or thigh, or swollen leg)

## Progestin only pills (mini pills)

Progestin only pills (POP), also called mini pills, are oral contraceptives that contain one type of synthetic female hormone in the family of progesterone.

### *Types*

- |               |               |               |
|---------------|---------------|---------------|
| - Exluton     | - Microlut    | - Norgeal     |
| - Femulen 0.5 | - Micro-Novum | - Norgestrone |
| - Micronor    | - Neogest     | - Norstrel    |
| - Nor QD      | - Ovrette     |               |

### *Specific counselling issues*

Inform the client of the advantages and disadvantages.

### *Advantages*

- Very safe for majority of women
- Very effective if taken correctly
- Does not disturb breast milk production
- Less likely to cause headaches or raised blood pressures
- No increased risk of cardiovascular complications
- No health risks associated with oestrogen
- Can be used for emergency contraception

### *Disadvantages*

- The woman must take the one pill every day, preferably at the same time. POPs require more strict pill schedule than COCs
- For non-breastfeeding women, they are slightly less effective than combined pills
- Have common side effects, including frequent bleeding, irregular bleeding, prolonged bleeding, or amenorrhea, headaches, dizziness, mood changes, nausea, breast tenderness and abdominal pain
- Do not protect against STIs and HIV/AIDS

### *Effectiveness*

Breastfeeding women as commonly used, about one pregnancy occurs per 100 women using POPs over the first year. With perfect use there is less than one pregnancy over one year.

Non-breastfeeding women: as commonly used, 3 to 10 pregnancies per 100 women over one year. With perfect use, less than 1 pregnancy per 100 women over one year.

### *Women who can use POP without restriction (WHO Category 1)*

POP is suitable for women who:

- are of any age or parity, including nulliparous
- smoke at any age
- have non-migrainous headache or migraines without aura at any age
- have acute/flare hepatitis, chronic hepatitis or are carriers
- have mild (compensated) cirrhosis
- are obese
- have uterine fibroid
- are breastfeeding within six weeks to six months postpartum
- have blood pressure below 160/100 mmHg
- have puerperal and postabortion sepsis
- have cervical cancer (pre-treatment) or cervical intraepithelial neoplasia/cervical carcinoma in situ (CIN)
- have endometrial or ovarian cancer
- have current and past pelvic inflammatory disease
- have increased risk of STIs or current STI including gonorrhoea and chlamydia
- have HIV infection or AIDS, but not on antiretroviral therapy
- take broad-spectrum antibiotics, antifungal or anti-parasitic medications

*Women who can generally use POP; some follow up may be needed (WHO Category 2)*

Women who have:

- blood pressure of 160/100 mm Hg and above
- history of deep vein thrombosis or current thrombosis, but established on anticoagulant therapy
- major surgery with prolonged immobilization
- history or current ischemic heart disease or stroke (initiation only; women who develop heart attack or stroke while using POPs reclassified as category 3)
- multiple risk factors for cardiovascular disease
- migraine with aura
- current diabetes with or without complications
- gall-bladder disease
- benign liver tumour, such as focal nodular hyperplasia
- antiretroviral therapy (unless the regimen contains ritonavir or ritonavir-boosted protease inhibitors)
- irregular, heavy or prolonged vaginal bleeding patterns and unexplained vaginal bleeding

*Use of POP usually not recommended in these women (WHO Category 3)*

Women who:

- have acute deep vein thrombosis
- have liver tumour (other than focal nodular hyperplasia)
- have severe (decompensated) cirrhosis
- are on Rifampicin/Rifabutin
- are taking ritonavir or ritonavir-boosted protease inhibitors as part of their ARV regimen
- have certain anti-convulsants, e.g. Phenytoin
- are breastfeeding up to six weeks postpartum
- developed heart attack or stroke while taking POPs
- noticed their migraine with aura became worse while taking POP

- women with history of breast cancer and no evidence of current disease for 5 years

*Women who should not use POP (WHO Category 4)*

- Women with current breast cancer

*Equipment and materials*

- Progestin-only pills
- Vaginal spermicides
- Condoms
- Clinic card
- Equipment for physical examination
- Visual aids

**Procedure**

*Client preparation*

- Greet client and offer a seat
- Make her comfortable and relaxed
- Find out what she already knows about POP and fill any gaps in her knowledge
- Provide adequate information on the pills including advantages, disadvantages and side effects
- Take a thorough history of the client
- Physical and pelvic examination is not necessary for safe initiation of POPs but should be offered in clinical settings as part of good preventive healthcare.
- Give the client one cycle of pills and a one month appointment if she is a new client. If she is a revisit client, give her three cycles of pills and an appointment to return in three months.
- Ensure that the client wishes to use the mini pills and has no contraindication to them.

### *When to initiate POP*

- The woman can start any day during the menstrual cycle when it is reasonably certain that she is not pregnant. If she starts within 5 days after the start of her monthly bleeding, no need for a backup method. If she starts after day 5, she will need a backup method for the first 2 days of taking pills.
- As early as six weeks after childbirth
- If she is breastfeeding and has no monthly bleeding she can start any time, but will have to use a backup method for the first 2 days of taking pills if it has been more than 6 months after childbirth

### *Specific instruction to POP users*

- Supply three packets of mini pills
- Take one pill every day, preferably at the same time
- Missing pills may lead to pregnancy
- After one pack is finished, start the next pack on the very next day without a break
- If pill is taken five days after menstruation had started, use protection or abstain from sex for two days
- Be aware that menstrual bleeding may become irregular, frequent or infrequent, prolonged, or stop altogether
- Report to the clinic if the following occurs:
  - You think you might be pregnant (e.g. you missed taking pills)
  - You are prescribed drugs for TB or seizures, or starting ARV treatment for AIDS
  - You have any concerns or problems

### *Important things the client should remember if she misses pill(s)*

- Remind the client to take one pill every day at the same time

- If she is 3 or more hours late taking a pill or misses one or more completely, instruct the client to take the forgotten pill as soon as she remembers and take the day's pill at the usual time.
- In addition, if she has monthly bleedings, she should use a barrier method for the next two days
- Instruct the client to consider changing to another method if she keeps forgetting
- If the client experiences severe vomiting or diarrhoea, instruct her to use a barrier method or avoid sex for two days after the illness is over. If she vomits within 2 hours after taking a pill, she should take another pill from her pack as soon as possible and keep taking pills as usual

## ***Follow-up***

### *First follow-up visit*

- Check blood pressure and weight
- Ask if there are any side effects, respond to them and reassure her
- Rehearse the method of taking pills with client
- Give six months supply if client shows the ability to use pills correctly
- Breastfeeding women: explore if she is planning to continue taking POPs after she stops breastfeeding. If not, discuss other available methods and help her make an informed choice
- Instruct the client to come for re-supply before the last packet finishes
- If she keeps missing pills or not sure in her ability to take pills correctly, help her choose another method
- See her every six months for check-up and re-supply
- Inform her that she can return to the clinic without appointment anytime she has problems or doubts
- Encourage her to carry out self breast examination monthly

### *One year visit*

- Take client's history
- Ask if she has experienced any side effects or has danger signals and manage as appropriate
- Carry out full physical examination, including:
  - weight
  - blood pressure
  - heart examination
  - breast examination
  - abdominal examination
  - calves and thighs examination
  - pelvic examination (speculum and digital)
  - Give supply of pills (six packets at six monthly intervals)
  - Record findings in the client's record
  - Give return appointment for six months
  - Encourage client to do pap smear test every 2–5 years



## Management of problems associated with POPs

<b>Spotting, irregular bleeding</b>	
History and examination	<p>Ask the client:</p> <ul style="list-style-type: none"> <li>• if she missed taking any pills</li> <li>• for how many days spotting occurs</li> <li>• if spotting is associated with pelvic pains or abnormal vaginal discharge</li> <li>• if spotting occurs after intercourse</li> <li>• if she had severe vomiting or diarrhoea</li> <li>• for date of last menstrual period (if applicable)</li> </ul> <p>Conduct pelvic exam if underlying condition is suspected, such as infection, miscarriage or ectopic pregnancy</p>
If woman did not miss any pills and has no other symptoms	<ul style="list-style-type: none"> <li>• Reassure she is most likely not pregnant</li> <li>• Counsel that irregular bleeding and spotting are common side effects of POPs and pose no risk to woman's health</li> <li>• Suggest ibuprofen (800 mg 3 times a day for 5 days) for a short term relief, beginning with when irregular bleeding starts.</li> <li>• If she has been taking POPs for more than a few months, suggest a different POP formulation</li> </ul>
If spotting is due to infection	<ul style="list-style-type: none"> <li>• Manage according to procedure explained in Chapter 12 on STI</li> </ul>
If spotting is due to suspected ectopic pregnancy	<ul style="list-style-type: none"> <li>• Refer to hospital immediately</li> </ul>
If spotting is due to early pregnancy	<ul style="list-style-type: none"> <li>• Stop pills</li> <li>• Refer to antenatal clinic</li> </ul>

### Absence of menses (amenorrhea)

History and examination	<p>Ask the client:</p> <ul style="list-style-type: none"> <li>• if she is breastfeeding</li> <li>• how she has been taking the pills and if there were any forgotten or late pills</li> <li>• if she takes any medication with mini pills, which could lower the effectiveness</li> <li>• if she had severe vomiting or diarrhoea</li> <li>• if she has any symptoms of pregnancy</li> </ul> <p>Perform pelvic examination if appropriate to rule out pregnancy</p>
If taking pills correctly and not pregnant	<ul style="list-style-type: none"> <li>• Re-assure client that amenorrhea is common in women taking POPs, especially if they are breastfeeding</li> <li>• Encourage her to continue taking pills on schedule</li> </ul>
If amenorrhea is not acceptable to client	<ul style="list-style-type: none"> <li>• Counsel her about other available contraceptive methods which do not cause amenorrhea, help her to make an informed choice</li> </ul>
If pregnant or ectopic pregnancy is suspected	<ul style="list-style-type: none"> <li>• Stop pills</li> <li>• Refer to ANC immediately</li> </ul>

<b>Severe pain in low abdomen</b>	
History and examination	<p>Ask if client:</p> <ul style="list-style-type: none"> <li>• was taking her pills on schedule, without missing any</li> <li>• if she has regular menses, when was her last period</li> <li>• if her bleeding pattern have changed recently</li> <li>• if she feels lightheaded or dizzy</li> </ul> <p>Conduct abdominal and pelvic examination or refer to specialist to rule out ectopic pregnancy or other reasons for acute abdomen</p>
If ectopic pregnancy is suspected	<ul style="list-style-type: none"> <li>• Refer to specialist immediately</li> </ul>
If due to enlarged ovarian follicle or cyst	<ul style="list-style-type: none"> <li>• There is no need to treat unless they grow abnormally large, twist or burst.</li> <li>• Reassure client that they usually disappear on their own</li> <li>• Follow-up in 6 weeks</li> <li>• Refer to specialist if in doubt or if pain becomes worse</li> </ul>

## Emergency contraception

Emergency contraception (EC) is a safe and effective way of preventing pregnancy after having unprotected sexual intercourse or after a contraceptive accident, such as condom slippage or breakage and dislodgement of diaphragm. Emergency contraception can be achieved by the use of special dose of hormonal oral contraceptive pills within 5 days after unprotected sexual intercourse to prevent pregnancy.

**Emergency contraception has no effect on already established pregnancy**

The other type of emergency contraception is the intrauterine device (IUD). IUD must be inserted within five days after unprotected vaginal intercourse and it can be taken out by a health care provider after the woman's next period. It also can be left in place for up to 12 years if the woman decides to use it as her regular method of birth control.

### **Effectiveness of emergency contraceptive pills**

If taken within 120 hours after unprotected intercourse, ECPs prevent 75% to 95% of expected pregnancies. The sooner ECPs are taken after unprotected sex, the more effective they are. Also progestin-only regimen of ECPs is more effective than combined pills regimen.

#### *Specific counselling issues*

Discuss the common side effects associated with emergency contraceptive pills (ECPs) with the client:

- Nausea (it does not last for more than 24 hours)
- Vomiting occurs in 20% of women
- Irregular bleeding or spotting
- Breast tenderness
- Headache
- Dizziness
- Menstrual cycle disturbance: the next menstrual bleeding may be a few days early or late

#### *Advantages*

- ECs are safe for all women regardless of age and health status
- EC drugs exposure and side effects are of short duration
- ECs are readily available (combined oral contraceptives are more readily available for emergency contraception throughout the country)
- They are convenient and easy to use
- They significantly reduce the risk of unwanted pregnancy

- They reduce the need for abortion
- They are appropriate for young women who may have unplanned sex
- They can provide a bridge to the practice of regular contraception

#### *Disadvantages*

- ECs offer no protection against the transmission of STIs and HIV/AIDS
- They must be used within five days of unprotected intercourse. The sooner they are taken after unprotected sex the higher the efficacy
- They are less effective than regular contraceptives
- They may produce nausea and sometimes vomiting
- They may change the time of the women's next menstrual period

#### *Women who can use emergency contraceptives*

All women can use emergency contraceptive pills safely and effectively, including women who cannot use continuing hormonal contraceptive methods. Because of the short-term nature of their use there are no medical conditions that make emergency contraceptive pills unsafe for any woman.

#### *Equipment and materials*

- Progestin only pills, e.g. Ovran, Ovrette or Ovidon
- Combined oral contraceptives, e.g. Duofem,
- Clinic card
- Equipment for physical examination
- Visual aids

## ***Instructions to the client***

*High dose COC formulations (those containing 50 mcg of oestrogen in each pill)*

- Take two pills immediately or within 120 hours (or up to five days) of unprotected sex
- Take additional two pills 12 hours after the first dose. Examples are Neogynon, Nontiol, Duofem, Ovral, etc.

*Low dose COC formulations (those containing 30 mcg of oestrogen)*

- Take four pills immediately or within 120 hours (up to five days) of unprotected sex
- Take additional four pills 12 hours after the first dose. Examples are Microgynon 30, Nordette, Lo-Femenal, etc.

*Progestin only pills (specially designated for emergency contraception, such as Postinor-2)*

- Take two tablets of Postinor-2 within 120 hours (up to five days) after unprotected sex **or**
- Take one tablet of Postinor-2 can within 120 hours after unprotected sex and take another tablet of Postinor-2, 12 hours after the first dose
- For details on dosage refer to Table 6.1

*Important instructions for clients*

- Drinking milk or eating food with the pill or taking them near bedtime may help reduce nausea
- The dosage needs to be repeated if the client vomits within two hours of taking ECPs
- Counsel client about ongoing contraception and help her choose a method.
- All methods but implants can be initiated on the same or next day after ECPs were used
- If client wants to delay initiation until the next menses,

instruct her to use a barrier method (e.g. condom) for the remaining part of her cycle. Provide her with condoms.

- If the menstrual period is more than a week late or if there is a concern, client should come back or visit a referral clinic

#### *Follow-up*

- Provide follow-up care as follows:
  - Ask about her state of health
  - Record her menstrual date to verify that she is not pregnant
  - If not sure, do a pregnancy test
  - Discuss contraceptive option as appropriate

#### *When ECP fails and client is pregnant*

- Explain available options to the client
- Allow client to make a decision that is most comfortable to her
- If client decides to continue with pregnancy, re-assure her that ECP does not have any known harmful effect
- Refer the client to other service providers as appropriate.

**Table 6.1: Formulation and dosage for emergency contraception**

Formulation	Common brand names	Tablets per dose	Doses required	Timing of administration
EE 50 mcg +LNG 0.25	Neogynon, Noral Nordiol, Ovidon, Ovral	2	2	First dose within 120 hours of unprotected sex, second dose 12 hours later
Or EE 50 mcg +NG 0.50 mg	Eugynon	2	2	First dose within 120 hours of unprotected sex, second dose 12 hours later
EE 30 mcg LNG 0.15 mg or EE 30 mcg NG 0.3 mg	Microgynon 30, Nordette, Rivevidon, Confidence, Lo-femenal, Ovral 1, Duofem	4 4	2 2	First dose within 120 hours of unprotected sex, second dose 12 hours later
LNG 0.75 mg	Postinor-2	2	1	Take within 120 hours of unprotected sex



Formulation	Common brand names	Tablets per dose	Doses required	Timing of administration
LNG 0.03 mg or	Microlut, Norgeston, Microval	25	2	First dose within 120 hours of unprotected sex, second dose 12 hours later
NG 0.075 mg	Ovrette	20	2	

*EE = Ethinyl estradiol; LNG = Levonorgestrel; NG = Norgestrel  
The client may repeat the dose with anti-emetics or consider administering the dose vaginally*

### Management of problems associated with emergency contraceptive pills

Complaint	Management
To minimize nausea and vomiting	<ul style="list-style-type: none"> <li>Advise client to take each dose with food</li> <li>Taking the first dose at bed time may reduce nausea and vomiting</li> <li>There is decreased nausea and vomiting if anti-emetics are taken as prophylaxis (routine use is not recommended)</li> </ul>
If vomiting occurs within two hours of taking the first or second dose	<ul style="list-style-type: none"> <li>Repeat the dose</li> </ul>
Irregular bleeding	<ul style="list-style-type: none"> <li>Tell the client that irregular bleeding will stop without treatment soon</li> <li>Advise that next menses may start a few days earlier or later than expected. In case menses are delayed by more than a week, return for a pregnancy test</li> </ul>
Headache and breast tenderness	<ul style="list-style-type: none"> <li>Re-assure client</li> <li>Give paracetamol or other pain relievers</li> </ul>

# Injectables

## Description

Injectables are hormonal contraceptives that contain combined oestrogen and progestin or progestin only, and are given by intramuscular injection. They provide contraceptive protection from one to three months, depending on type.

## Objectives

- To provide information on injectables in order to help clients to make informed method choice
- To screen clients for eligibility and provide injectable contraceptives to the client who does not have contraindications to its use
- To review the client using injectable hormones periodically and respond to any concerns and problems she may have
- To identify and manage problems that may arise from the use of injectable contraceptives

## Types of injectables

### Progestin-only injectable contraceptives

- Norethisterone enanthate (Noristerat, NET-EN)
- Depot-medroxy-progesterone acetate (DMPA, Depo-Provera)

### Combined injectable contraceptives

- Cyclofem
- Mesigyna

**Table 7.1: Injectable contraceptives, their hormonal contents and frequency of injections**

Product	Oestrogen	Progestin	Frequency of injections
Depot-medroxy progesterone acetate (DMPA)	Nil	150 mg depot-medroxy progesterone	Every 3 months
Norethisterone enanthate (NET-EN)	Nil	200 mg norethisterone enanthate	Every 2 months
Mesigyna (Norigynon)	5 mg estradol valerate	50 mg norethisterone enanthate	Every 1 month
Cyclofem	5 mg estradol cypionate	25 mg depot-medroxy progesterone acetate	Every 1 month

## Specific counselling issues for progestin-only injectable contraceptives

### *Advantages*

- Progestin only contraceptives are highly effective and safe
- They have minimal client dependence
- They are not related to sexual intercourse
- They are culturally acceptable
- They make sickle cell crises less frequent and less painful
- They may protect from iron-deficiency anemia
- They may protect against symptomatic pelvic inflammatory diseases
- They protect from endometrial cancer and uterine fibroids
- They reduce symptoms of endometriosis

- They do not decrease breast milk production
- They may protect against ectopic pregnancy
- They offer privacy
- Progestin only injectable contraceptives have no drug interaction
- They have no known health risks

### *Disadvantages*

- Progestin only injectables require regular visits to the clinic (2–3 months interval)
- They have common side effects including:
  - irregular, prolonged or heavy bleeding
  - infrequent bleeding or absence of bleeding (amenorrhea)
  - weight gain,
  - headaches, dizziness, mood change, decrease in sex drive
- Return of fertility may be delayed
- They do not protect against STI/HIV/AIDS

### *Effectiveness*

As commonly used, about three pregnancies occur per 100 women using progestin only injectables over the first year. When women have injections on time (perfect use), less than one pregnancy occurs per 100 women in the first year of use.

### *Women who can use progestin-only injectables without restriction (WHO Category 1)*

Women who:

- are between 18 and 45 years old
- are smoking at any age
- are nulliparous
- have puerperal and post-abortion sepsis
- have current and past pelvic inflammatory disease

- are at increased risk of STIs or have current STI, including gonorrhoea and chlamydia infection
- are HIV- infected, have AIDS or are on ART, including ritonavir (ART applies to DMPA only)
- have non-migrainous headache
- have uterine fibroid
- are breastfeeding anytime after six weeks postpartum
- are obese
- have depressive disorders
- have acute/flare hepatitis, chronic hepatitis or are carriers
- take any medication, including anti-TB and anti-seizure medications (applies to DMPA only, NET-EN is category 2)
- have severe dysmenorrhoea
- have endometrial or ovarian cancer

*Women who can generally use progestin only injectables; some follow up may be needed (WHO Category 2)*

Women who:

- are less than 18 or older than 45 years
- use certain anti-convulsants, e.g. Phenytoin or anti-TB drugs, e.g. rifampicin/rifabutin (applies to NET-EN only, DMPA is category 1)
- are on ARV therapy, including ritonavir (applies to NET-EN only)
- have migraine with or without aura
- had major surgery with prolonged immobilization
- have history of deep vein thrombosis
- have blood pressure below 160/100 mmHg
- have irregular, heavy or prolong vaginal bleeding patterns
- have gall-bladder disease
- have benign liver tumour, such as focal nodular hyperplasia
- have rheumatic disease such as lupus erythematosus if negative for antiphospholipid antibodies

- have cervical cancer (pre-treatment) or cervical intraepithelial neoplasm (CIN)
- have diabetes without vascular complications

*Use of progestin only injectables usually not recommended in these women (WHO Category 3)*

Women who:

- have acute deep vein thrombosis
- have liver tumour (other than focal nodular hyperplasia)
- are breastfeeding up to six weeks postpartum
- have blood pressure 160/100 mmHg and above
- have diabetes with vascular complications
- have unexplained vaginal bleeding (before evaluation)
- have multiple risk factors for cardiovascular disease
- have current or history of stroke or ischaemic heart disease
- noticed their migraines with aura getting worse while taking progestin-only injectables
- have rheumatic disease such as lupus erythematosus with positive or unknown antiphospholipid antibodies
- history of breast cancer and no evidence of current disease for 5 years

*Women who should not use progestin only injectables (WHO Category 4).*

- Women who have breast cancer (current)

## **Specific counselling issues for combined injectable contraceptives**

*Advantages*

- Combined injectable contraceptives are highly effective (0.1–0.4 pregnancies occur per 100 women during the first year of use if used perfectly)

- They are effective immediately if started within 7 days after the start of monthly bleeding
- They do not require pelvic examination prior to use
- They are given once a month
- They are convenient and easy to use
- They do not interfere with sexual intercourse
- They can be provided by a trained non-medical personnel
- They may protect against ectopic pregnancy
- They offer privacy
- They may offer the same health benefits as COCs (see COC section)

### *Disadvantages*

- Combined injectable contraceptives require regular visits to the clinic (monthly)
- Return to fertility may be delayed approximately by one month compared to non-hormonal methods, oral contraceptives or implants
- They do not protect against STIs, HIV/AIDS and HPV
- They have common side effects:
  - Lighter bleeding, irregular bleeding, prolonged bleeding
  - Infrequent bleeding or absence of bleeding (amenorrhea)
  - headache, mild breast tenderness, dizziness, weight gain

*Note:* Although this section includes discussion on combined injectable contraceptives, information relating to their use is similar to that for combined oral contraceptives. Please refer to Chapter 6 for detail information on their use.

## Equipment and materials

- Depo-Provera, Noristerat, Cyclofem or Mesigyna
- Client cards
- Equipment for medical check
- Tray or kidney dish, galipot, syringes and needles
- Vaginal spermicides or condoms

## Procedure

### *When to initiate progestin only injectables*

- Anytime it is reasonably certain that a woman is not pregnant
  - If initiated within the first 7 days of menstrual cycle, no back-up method needed
  - If initiated after the first 7 days of menstrual cycle, client will have to use a back-up method (e.g. condom) for the first 7 days after injection
- Six weeks after childbirth
- Immediately after a miscarriage or abortion
- Immediately after stopping another method

### *When to initiate Cyclofem*

- Anytime during menstrual cycle when you can be reasonably sure that the client is not pregnant
  - If initiated within the first 7 days of menstrual cycle, no back-up method needed
  - If initiated after the first 7 days of menstrual cycle, client will have to use a back-up method (e.g. condom) for the first 7 days after injection
- Postpartum
  - After six months if breastfeeding
  - After three weeks if not breastfeeding
  - Post-abortion (immediately or within seven days)



### *Client preparation*

- Ensure privacy for the client and make her comfortable and relaxed
- Find out what the client knows about injectables and fill in any gaps in her knowledge
- Explain the advantages, disadvantages, side effects and complications
- Make sure the client fully understands
- Explain that the drug is given by intramuscular injection every three months (13 weeks) for Depo-Provera or every two months (eight weeks) for Noristerat, and every month or four weeks for Cyclofem
- Explain that after discontinuing use, she may experience delay in return to fertility
- Obtain client history and screen for eligibility using the **screening checklist for initiation of injectables.**
- Perform a complete physical examination (not necessary for the safe initiation of injectables, but should be offered to a woman as part of good preventive medicine practices)
- Perform a speculum examination and where available pap smear (not necessary for the safe initiation of injectables, but should be offered to a woman as part of good preventive medicine practices)
- Give injection during the first seven days of menstruation. If client begins injection after seven days of menstrual period and it is reasonably certain she is not pregnant, she should use a barrier (back-up) method or avoid sex for the first seven days after the injection
- Follow normal procedure for giving intramuscular injection

### *Giving the injection*

- Check the label carefully
- Rock the bottle to and fro to allow the contents mix properly

- *Do not shake the bottle vigorously* because this produces foam, which makes complete withdrawal difficult thus reducing the desired dosage
- For NET-EN, rub vial in-between the palm to enhance withdrawal of the oily content
- *Do not heat up the Noristerat ampoule* as this will reduce the potency of the drug
- Wash hands
- No need to wipe top of vial with antiseptic
- Pierce top of vial with sterile needle and fill syringe with proper dosage, withdraw contents and expel any air from syringe
- Clean the injection site with cotton wool soaked in methylated spirit or water
- Inject the drug slowly
- Apply pressure on injection site with the cotton wool to prevent bleeding
- Do not rub injection site
- Dispose needle and syringe (see Chapter 19)
- Record all information and actions on client's card

#### *Post-injection instructions*

Give client the following instructions:

- Do not to rub injection site because this can hasten absorption and reduce duration of efficacy
- Irregular, heavy or prolonged bleeding or amenorrhea (no menses) may be experienced – this is normal with injectables use and not harmful to your health
- Return to the clinic in three months (13 weeks) for repeat injection if on Depo-Provera, or two months (eight weeks) if on Noristerat and one month (four weeks) for Cyclofem
- Encourage client to keep appointments, but come back even if she is late for her re-injection
- Return to the clinic if the following is experienced:

- Suspicion about pregnancy
- Any concerns about the method
- Migraines with aura became worse while using progestin-only injectables
- If there are any significant changes in her health which may or may not be related to the use of injectable contraceptives (e.g. she had heart attack or stroke, or deep venous thrombosis)
- Heavy bleeding that concerns her
- Jaundice
- Client should inform the physician that she is using injectable contraception whenever she consults a physician or is admitted to hospital

### *Follow-up visits*

The client should return to the clinic every 13 weeks for Depo-Provera, eight weeks for Noristerat and four weeks for Cyclofem/Mesigyna. At follow up visit:

- Take history
- Review the client's record card
- Ask if she has questions, complaints or concerns, or is satisfied with the method
- Ask if she had any major changes in her health status since her last visit.
- Ask about menstruation: date, duration and quantity (most women have irregular bleeding or amenorrhea while using progestin-only injectables, but some women will maintain regular cycles)
- Ask if she has been doing self breast examination
- Check weight
- Check blood pressure, if possible
- If the client is satisfied and has no contraindications to continue use, give repeat injection

- Client may be given re-injection up to 2 weeks earlier or 4 weeks later than her scheduled re-injection date (for Depo-Provera), 2 weeks earlier or 2 weeks later than scheduled re-injection date for Net-En, and up to 7 days earlier or later for Cyclofem
- Give follow-up appointment
- Record actions and findings on client's card

*Every 12 months*

- Review the client's record
- Obtain history and update your record
- Perform a complete physical examination, including pap smear
- Give repeat injection
- Give follow-up appointment

*Managing late DMPA injection (for NET-EN, substitute references to 4 weeks by 2 weeks; for Cyclofem, substitute references to 4 weeks by 1 week)*

- If the client is less than four weeks late for a repeat injection, she can receive her next injection. No need for pregnancy tests, evaluation, or a back-up method.
- A client who is more than four weeks late can receive her next injection if:
  - she has not had sex since *four weeks after* she should have had her last injection
  - she has used a back-up method or has taken emergency contraceptive pills after any unprotected sex since *four weeks after* she should have had her last injection
  - she is fully or nearly fully breastfeeding and she gave birth less than six months ago
  - she will need a back-up method for the first seven days after the injection

- If the client is more than four weeks late and does not meet these criteria, additional steps can be taken to be reasonably certain that she is not pregnant (e.g pelvic exam, pregnancy test).

*Note:* These steps are helpful because many women who have been using progestin only injectables will have no monthly bleeding for at least a few months, even after discontinuation. Thus, asking her to come back during her next monthly bleeding means her next injection could be unnecessarily delayed, possibly leaving her without contraceptive protection.

## Management of problems associated with injectables

Irregular bleeding or spotting	
History and examination	<p>Ask the client:</p> <ul style="list-style-type: none"> <li>• how long spotting/bleeding has been occurring</li> <li>• if spotting is associated with pelvic pain, pain with intercourse, or post-coital bleeding</li> </ul> <p><i>Physical examination</i></p> <ul style="list-style-type: none"> <li>• If underlying condition is suspected based on history, perform a pelvic examination to exclude other causes such as fibroids, miscarriage, pelvic inflammatory disease, cervical polyp, inflammation, cancer, pregnancy</li> </ul>

### Irregular bleeding or spotting

<p>If no underlying condition is suspected</p>	<ul style="list-style-type: none"><li>• Reassure that most women who use injectables experience irregular bleeding. It is not harmful and usually becomes less or stops after a few months.</li><li>• encourage intake of food rich in iron</li><li>• offer low dose combined oral contraceptive for 21 days or 2–3 cycles (this may temporarily reduce the bleeding)</li><li>• For modest short-term relief suggest ibuprofen (800 mg, 3 times a day for 5 days), beginning when irregular bleeding starts (other non-steroidal anti-inflammatory drugs but NOT ASPIRIN may be given)</li></ul> <p><i>No uterine curettage is needed</i></p> <ul style="list-style-type: none"><li>• If there is no improvement and woman finds bleeding unacceptable, help her choose another method</li></ul>
<p>Underlying condition, such as infection, genital cancer, miscarriage or ectopic pregnancy is suspected based on history or pelvic examination</p>	<ul style="list-style-type: none"><li>• Refer to a specialist without delay</li></ul>

<b>Heavy prolonged bleeding</b>	
History and examination	<p>Ask client the:</p> <ul style="list-style-type: none"> <li>• Duration of bleeding</li> <li>• Number of pads soaked per day</li> <li>• Feeling of weakness, dizziness</li> <li>• Pelvic pain, pain with intercourse</li> <li>• Date of last menstrual period (if her menses remain regular while on injectable contraceptives)</li> <li>• Symptoms of pregnancy</li> </ul> <p><i>Physical examination</i></p> <ul style="list-style-type: none"> <li>• Check conjunctiva, nail beds for pallor</li> <li>• If underlying condition is suspected, perform a pelvic examination to exclude fibroids, spontaneous abortion, or infection</li> </ul> <p><i>Test</i></p> <ul style="list-style-type: none"> <li>• Do a pregnancy test if she was more than 4 weeks late for injection</li> <li>• Check Hb/PCV</li> </ul>
If no underlying condition is suspected	<ul style="list-style-type: none"> <li>• Reassure that some women using injectable contraceptives experience heavy or prolonged bleeding. It is not harmful and usually becomes less or stops after a few months</li> <li>• Suggest ibuprofen or short course of COCs as described above (Irregular bleeding or spotting section)</li> <li>• Prescribe iron tablets and suggest to eat foods containing iron</li> <li>• If bleeding is unacceptable to a woman or becomes a health threat, help her choose another method</li> </ul>
If due to infection	<ul style="list-style-type: none"> <li>• Manage client according to procedure for STIs in Chapter 12</li> </ul>
If due to gynaecological causes unrelated to injectables	<ul style="list-style-type: none"> <li>• Refer client to the specialist without delay</li> </ul>

## Amenorrhea

<p>History and examination</p>	<p>Ask the client:</p> <ul style="list-style-type: none"> <li>• if menstruation was regular before beginning the injection</li> <li>• how long menses has been absent (date of last menstrual period)</li> <li>• any missed injections</li> <li>• any symptoms of pregnancy</li> </ul> <p><i>Physical examination</i></p> <ul style="list-style-type: none"> <li>• If client missed re-injection or was late by more than 4 weeks for DMPA (2 weeks for NET-EN, 1 week for Cyclofem), rule out pregnancy either by pelvic exam or pregnancy test</li> </ul>
<p>If no missed or delayed injections</p>	<ul style="list-style-type: none"> <li>• Re-assure client that most women using progestin-only injectables stop having monthly bleedings. This is to be expected and not harmful. Monthly bleedings will return after injectables are discontinued.</li> <li>• Inform client that if absence of menses is not acceptable to her, she may change to another method</li> </ul>
<p>If pregnant</p>	<ul style="list-style-type: none"> <li>• Refer client to antenatal clinic</li> </ul>
<p>If examination findings suggest underlying condition (e.g. polycystic ovarian syndrome)</p>	<ul style="list-style-type: none"> <li>• Refer client to the specialist</li> </ul>



Headaches	
History and examination	<ul style="list-style-type: none"> <li>• Ask the client to describe the headache if headaches were present before the injection or not</li> <li>• Any associated symptoms like dizziness, blurred vision, nausea/flushes of light</li> <li>• Other causes, e.g. social, financial and physical stress</li> </ul> <p><i>Physical examination</i></p> <ul style="list-style-type: none"> <li>• Measure blood pressure</li> </ul>
If ordinary headaches	<ul style="list-style-type: none"> <li>• Suggest painkillers, such as ibuprofen or paracetamol, or other available pain relievers</li> </ul>
If migraines	<ul style="list-style-type: none"> <li>• If her migraines became more frequent or more severe while using injectables, or she developed aura, discontinue injections</li> <li>• Help her choose another method without hormones</li> </ul>
If due to elevated blood pressure	<ul style="list-style-type: none"> <li>• If BP is 160/100 or higher, stop further injection and give non-hormonal method</li> <li>• Refer to specialist as needed</li> </ul>

Loss of libido	
History and examination	<p>Ask the client:</p> <ul style="list-style-type: none"> <li>• if loss of libido occurred before beginning injection or since beginning injection</li> <li>• if there is any pelvic pain, pain during intercourse, dryness, or vaginal discharge</li> <li>• if there are any marital or social problems</li> </ul> <p><i>Physical examination</i></p> <ul style="list-style-type: none"> <li>• If underlying condition is suspected, do pelvic examination to exclude trauma or infection</li> </ul>
If no underlying condition is suspected	<ul style="list-style-type: none"> <li>• Provide counselling and support as appropriate</li> <li>• If due to social/marital problems, refer to a social worker</li> <li>• If loss of libido is unacceptable to client, help her choose another method</li> </ul>
If loss of libido is due to infection or trauma	<ul style="list-style-type: none"> <li>• Manage client according to procedure for STIs in Chapter 12 or refer to the specialist</li> </ul>
If due to dryness of vagina	<ul style="list-style-type: none"> <li>• Advise client on use of water-based lubricants such as KY Jelly or contraceptive jelly</li> </ul>

## Excessive weight gain

History and examination	<p>Ask the client:</p> <ul style="list-style-type: none"> <li>• if there is any change in lifestyle activities</li> <li>• if there is increase in appetite</li> <li>• about dietary intake of fats, starches, sugar, pattern of eating</li> <li>• if weight gain started since injection</li> <li>• date of last menstrual period</li> <li>• symptoms of pregnancy</li> </ul> <p><i>Physical examination</i></p> <ul style="list-style-type: none"> <li>• Take and compare weight to previous readings</li> <li>• If pregnancy is suspected (e.g. she missed or was late for re-injection), perform pelvic examination or do pregnancy test to rule out pregnancy</li> </ul>
If no other reasons for weight gain are identified	<ul style="list-style-type: none"> <li>• Counsel that women who use injectables can gain some weight</li> <li>• If weight gain is unacceptable to client, help her choose another method</li> </ul>
If weight gain is due to pregnancy	<ul style="list-style-type: none"> <li>• Refer client to antenatal clinic</li> </ul>
If weight gain is due to dietary intake and pattern of eating	<ul style="list-style-type: none"> <li>• Advise client to decrease intake of fats, starch and sugar and increase intake of vegetables and protein</li> <li>• If possible, avoid eating in-between meals</li> <li>• Advise on regular physical exercise</li> </ul>

<b>Mood changes</b>	
History and examination	<p>Ask the client:</p> <ul style="list-style-type: none"> <li>• About history of mood changes</li> <li>• when mood changes were noted</li> <li>• if there is any marital or social problem</li> </ul> <p><i>Physical examination</i></p> <ul style="list-style-type: none"> <li>• Observe general appearance for signs of neglect, body carriage, facial expression, speech and degree of concentration</li> </ul>
If no other reasons for mood changes	<ul style="list-style-type: none"> <li>• Counsel that injectables can be the cause of mood changes.</li> <li>• If mood changes are mild, give support or refer as appropriate</li> <li>• If mood changes are unacceptable to client, help her choose another method</li> </ul>
If depression is suspected	<ul style="list-style-type: none"> <li>• Refer to psychiatrist immediately</li> </ul>

# Contraceptive implants

## Description

Contraceptive implants are progestin only contraceptives inserted under the skin of a woman's upper arm through a minor surgical procedure.

## Objectives

- To provide information on implants in order to help clients to make informed method choice
- To screen clients for conditions which may preclude safe use of contraceptive implants
- To ensure proper insertion of contraceptive implant in clients who can use them
- To identify and manage complaints arising from the use of contraceptive implant

## Types contraceptive implants

- Jadelle® — two silicon rods; each containing 75 mg levonorgestrel. It is an improved version of Norplant. Jadelle is effective for 5 years.
- Implanon — one rod containing a progestin called etonogestrel. Implanon is effective for 3 years.
- Sinoplant or sino-implant — two thin flexible silicon rods that contain 75 mg levonorgestrel each (similar to Jadelle). Effective for 5 years.
- Uniplant — one rod that contains 55mg of nomegestrol acetate.
- Norplant — six soft plastic rods that each contain 36 mg levonorgestrel. Effective for 5-7 years. Norplant has been

discontinued due to the availability of newer and better implants, but there are still women using it who will be due for removal over the next few years.

*Note:* Sinoplant is currently available only in China and Indonesia. If Sinoplant is registered in Africa, its public sector price is expected to be much lower than that of Jadelle.

## Specific counselling issues

Provide the following information to the client:

### *Advantages*

- No repeated visits to the clinic are required
- Contraceptive implants are effective immediately if inserted within the first 7 days of menstrual cycle (5 days for Implanon)
- They are very effective in preventing pregnancy and safe for majority of women
- They are long-acting
- They may help prevent iron deficiency anemia, symptomatic pelvic inflammatory disease, and ectopic pregnancy
- Do not disturb breast milk production
- Less likely to cause headaches or raised blood pressures than oestrogen-containing contraceptives
- No increased risk of cardio-vascular complications

### *Disadvantages*

- Contraceptive implants have common side effects:
  - may cause spotting and irregular vaginal bleeding for 60–70% of users
  - amenorrhea (less common than irregular bleeding with all implants, but Implanon)
  - headaches, abdominal pain, weight gain, breast tenderness, dizziness, nausea, mood change, acne
  - some women may develop enlarged ovarian follicles

- Insertion and removal involve minor surgical procedures and therefore may be associated with bruising (discolouration of the arm), infection or bleeding
- The client cannot discontinue the method on her own
- Outline of the rods may be visible under the skin of some women, especially when the skin is stretched
- Contraceptive implants do not protect a woman from STIs/ HIV/AIDS

### *Effectiveness*

- Less than one pregnancy occurs per 100 women using implants over the first year (5 per 10,000 women)
- About one pregnancy per 100 women for over five years of Jadelle use
- Less than one pregnancy per 100 women (1 per 1,000 women) for over three years use of Implanon
- Over four years for Sinoplant use: 0.3 to 1.1 pregnancies per 100 women in the first year of use
- Over seven years of Norplant use: about two pregnancies per 100 women

### *Women who can use implants without restriction (WHO Category 1)*

Women who:

- are of any age and parity, including nulliparous
- obese<sup>1</sup>
- have uterine fibroids
- are breastfeeding within six weeks to six months postpartum
- have puerperal and post-abortion sepsis
- have pelvic inflammatory disease (previous and present)
- have increased risk of STIs or current STIs, including gonorrhoea or chlamydia

---

<sup>1</sup>Implants start to lose effectiveness sooner for heavier women (>70kg): these women may have to replace their implants earlier.

- have HIV infection or AIDS, but are not on ARV therapy
- are smoking at any age
- have hypertension below 160/100 mmHg
- have non-migrainous headaches
- have depressive disorders
- have endometrial or ovarian cancer
- have iron-deficiency anemia or sickle cell disease
- have acute or flare hepatitis, chronic hepatitis, or carrier
- have mild (compensated cirrhosis)
- take broad-spectrum antibiotics, antifungal or antiparasitic medication

*Women who can generally use implants; some follow up may be needed (WHO Category 2)*

Women who have:

- drug interactions such as Rifampicin, Rifambutin, certain anti-convulsants, e.g. Phenytoin, ARVs
- cervical cancer (pre-treatment) or cervical intraepithelial neoplasia
- hypertension higher than 160/100 mm Hg
- history of DVT or current DVT while established on anticoagulant therapy
- major surgery with prolonged immobilization
- multiple risk factors for cardiovascular disease
- history or current ischaemic heart disease or stroke (for initiation only)
- migraine with aura at any age (for initiation only)
- diabetes with or without complications
- rheumatic disease, such as systemic lupus erythematosus if negative for antiphospholipid antibodies
- irregular or heavy vaginal bleeding patterns
- gall-bladder disease
- liver tumour, such as focal nodular hyperplasia



*Use of implants usually not recommended in these women (WHO Category 3);*

Women who:

- have unexplained vaginal bleeding
- have deep vein thrombosis (acute)
- have liver tumour other than focal nodular hyperplasia
- have severe (decompensated) cirrhosis
- are breastfeeding up to six weeks postpartum
- have rheumatic disease, such as systemic lupus erythematosus with positive or unknown antiphospholipid antibodies
- have history of breast cancer and no evidence of current disease for 5 years
- noticed their migraines with aura getting worse while using contraceptive implants
- were diagnosed with ischaemic heart disease or stroke while using implants

*Women who should not use contraceptive implants (WHO Category 4)*

- Women who have current breast cancer

## **Equipment and materials**

- One set of implant capsules
- Trocar and cannula as supplied
- Sterilized surgical drapes
- Sterile gloves preferably devoid of talcum powder
- Antiseptic solution like *Savlon*, *Hibitane* or *Betadine*
- Local anesthetic agent like *Xylocaine* 1%
- Syringe and needle
- Sterile gauze/cotton wool
- Plaster
- Artery forceps (2)

- Scalpel and blade (size 12) (optional)
- Examination couch with arm rest
- Disinfectant solution, e.g. *Jik*
- Plastic bowl

## Procedure

### Client preparation

- Screen the client for eligibility using the **screening checklist for initiation of contraceptive implants**.
- Listen to the client's concern and respond to her questions appropriately
- Give clear information about probable changes in bleeding pattern during the menstrual cycle and other possible side effects
- Describe the insertion and removal procedures and what the client should expect during and afterwards
- Ensure client's cooperation and relaxation
- Review client assessment data to determine if the client is an appropriate candidate for implants or if she has any problems that should be monitored more frequently while the implants are in place
- Do a general examination
- Do a pelvic examination if needed or requested by client (pelvic examinations are not necessary for safe implant initiation and use, but may be indicated for other reasons and are part of the preventive medicine practices and health promotion)

### Steps for inserting contraceptive implant

- Instruct the client to lie on the couch with arm stretched out comfortably
- Support arm with arm rest
- Use proper infection prevention procedure (see Chapter 19)

- Wash hands
- Clean the area of insertion with antiseptic solution: iodine (if available) and finally with spirit
- Apply sterile drapes exposing the insertion area only (under the skin of the upper arm).
- Using the standard technique, insert the Implant under the skin.
- Cover the insertion point with sterile dressing gauze, and plaster
- Apply bandage if necessary

*Note:* The insertion and removal procedures are similar for all implants.

### **Post-insertion care and instructions**

- Observe the client in the clinic for 15 minutes for signs of fainting or bleeding from insertion site
- Instruct the client to:
  - keep the insertion area dry and clean for five days
  - avoid carrying heavy load or applying unusual pressure to the site
  - inform the doctor that she is using contraceptive implant(s) if there is need for other medical treatment
- Return to the clinic if any of the following danger signs are experienced:
  - feeling unwell
  - fever
  - severe abdominal pain
  - pus at site of insertion, pain or redness
  - capsules falling out
- Return to the clinic at any time to receive advice and medical attention and, if desired, to have the rods removed
- Return for removal at the appointed time (a year earlier if she has gained a lot of weight)
- Request the client to repeat all instructions

- No scheduled follow-up required. It is usually recommended to come back for a yearly check-up for general health purposes
  - Write down clearly for the client the type of implant she has, date of insertion, month and year when implants will need to be removed/replaced (in 5 years for Jadelle/Sinoplant, 3 years for Implanon)

## Follow-up counselling

- Check whether the client is satisfied with method
- Inquire about problems and respond to concerns about side effects
- Re-assure the client that the rods can be removed at any time if desired
- Review the warning signs that indicate the need to return to the clinic
- Remind the client of removal date

## Removing contraceptive implant capsules

### Equipment and materials

- Sterilized surgical drapes
- Sterile syringe (5–10 mls) and needle (23G or 21G) to apply anesthesia
- Sterile gloves
- Antiseptic solution like *Savlon*, *Hibitane* or *Betadine*
- Local anesthetic agent, e.g. 1% *Xylocaine*
- Scalpel blade holder and surgical blade
- Artery forceps (mosquito) 2
- Examination couch with arm rest
- Sterile gauze and cotton swabs
- Disinfectant, e.g. *Jik*
- Plastic bowl

## Steps

- Position the client and prepare the area of procedure as for insertion of implant
- Raise the head of the examining table so that the client can be more comfortable
- Be sure you are comfortable. You may be more at ease sitting rather than standing
- Locate the implants by palpation, possibly marking the position
- Inject the local anesthetic slowly under the implants. It is recommended that you initially inject approximately 1 cc of 1% *Xylocaine*. Have an additional 2–5 cc of *Xylocaine* available, which can be used for the removal of each implant if required
- Make a 2–3 mm incision with the scalpel blade also to the ends of the implants. Do not make a large incision
- Rather than making the incision at exactly the same site as the location of the incision used to insert the implant, you may wish to make the incision as close as possible to the tip of all the implants. Some physicians use the incision so as to avoid a second scar
- If one implant is far from the other and cannot be reached, make a second incision
- Throughout the procedure, ask the client if she feels any pain and provide additional local anesthetic as needed
- With your finger, apply pressure to the distal end of each implant. Push the implant towards the incision with the fingers
- With a sharp blade, a gauze pad, or mosquito forceps, remove the scar tissue covering the implants (i.e. gently opening the tissue capsule around the implant (Figures 8.1–8.4))
- When the tip of the implant is visible in the incision, grasp it with the mosquito forceps

- Remove the implant from the incision with the second forceps

The removal of the implants should be performed very gently and will take more time than the insertion.



Figure 8.1: Jadelle implant



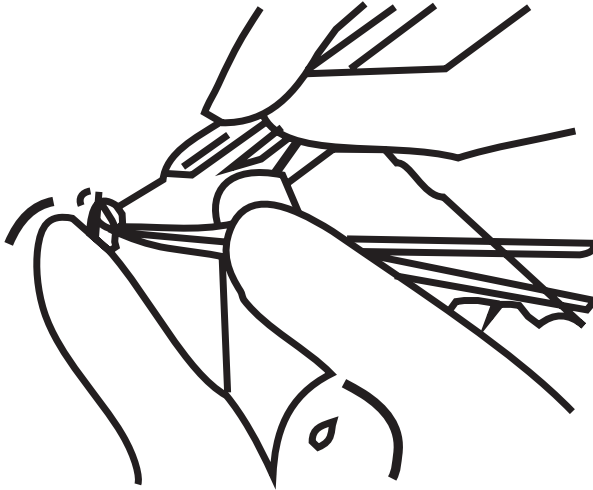
Figure 8.2: Implanon implant



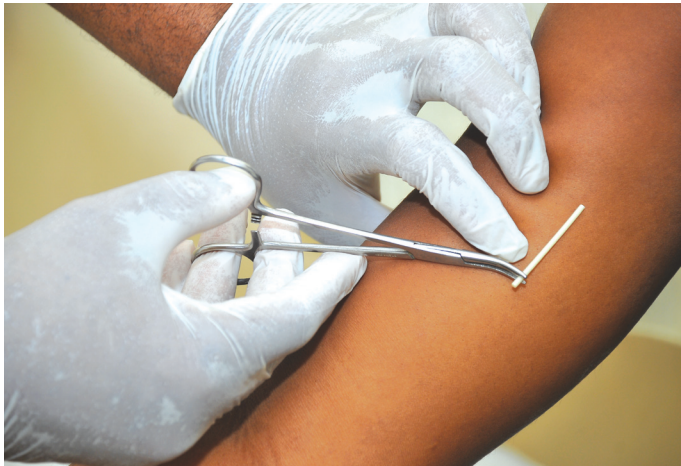
*Figure 8.3: Inserting implant just under the skin*



*Figure 8.4: Incision to remove the implant*



*Figure 8.5: Using scalpel to open the tissue capsule around the implant*



*Figure 8.6: Gently pull out the implant*



## Management of problems associated with contraceptive implants

Pain after insertion or removal	
If no signs of infection	<ul style="list-style-type: none"> <li>• Advise her to avoid pressing on the implants for a few days and never press on the implants if tender</li> <li>• Give Aspirin or another non-steroidal anti-inflammatory drug</li> </ul>
Infection at the insertion site	
If there is redness, heat, pain, pus	<ul style="list-style-type: none"> <li>• Do not remove the implants</li> <li>• Clean the infected area with soap and water or antiseptic</li> <li>• Given an oral antibiotic, e.g. Amoxicillin 500 gm tds for 7 days and ask the client to return in one week</li> <li>• Then if no improvement, remove the implants or refer for removal</li> </ul>
If there is an abscess	<ul style="list-style-type: none"> <li>• Clean the infected area with antiseptic, make an incision, and drain the pus</li> <li>• Treat the wound and given oral antibiotic for seven days</li> <li>• Ask client to return in 7 days if she still has symptoms (heat, pain, drainage, redness).If infection is still present, remove the implants or refer for removal. Help to choose another method</li> </ul>

## Irregular or heavy bleeding

### History and examination

Ask the client:

- the duration and quantity of bleeding
- if it coincides in timing with implants insertion
- the presence of abdominal pain or fainting spells

### *Physical examination*

- Check mucous membrane for colour and pallor
- Check weight
- Check blood pressure
- Check that the implant is still in place and complete
- If underlying condition is suspected, perform abdominal and pelvic examinations to exclude pregnancy or related complications, e.g. abortion or ectopic pregnancy (pregnancy is highly unlikely if it was ruled out prior to insertion of the implant and implant is still in place)

### *Test*

- Pregnancy test or a pelvic ultrasound if indicated
- Refer as indicated

### Irregular or heavy bleeding

If no underlying condition is suspected (implant is still in place and bleeding started after implant initiation)

- Reassure the client that bleeding changes are common in women who are using implants, they are not harmful and usually become less or stops altogether after the first year of use
- If the client finds the bleeding unacceptable and no oestrogen contraindication, offer:
  - one cycle of low-dose combined oral contraceptive (pill containing the progestin levonorgestrel). The same progestin present in the implants is best for controlling bleeding
  - Ibuprofen or other non-steroidal anti-inflammatory drugs, but not aspirin
- If bleeding is very heavy (twice as much as usual):
  - check for anaemia. If present, treat and refer
  - advise on food containing iron
- If bleeding is unacceptable to the client, help her choose another method and remove implant
  - uterine evacuation is not necessary and is contraindicated

### Irregular or heavy bleeding

If bleeding is due to gynaecological problems	<ul style="list-style-type: none"><li>• Treat or refer for care as appropriate</li></ul>
Unexplained abnormal vaginal bleeding that suggests underlying medical condition unrelated to method use	<ul style="list-style-type: none"><li>• The client can continue using implant while her condition is being evaluated</li><li>• If no cause of bleeding can be found, consider stopping implants to make diagnosis easier. Provide another method until the condition is evaluated and treated (other than hormonal method or IUD)</li><li>• Treat any underlying medical problems or refer for care. If bleeding is caused by STI or PID, she can continue using implants during treatment. If caused by cervical or endometrial cancer, she can continue using implants while awaiting treatment.</li></ul>

### Severe pain in lower abdomen

History and examination	<ul style="list-style-type: none"> <li>• Rule out ovarian cyst, complicated ovarian cyst, ovarian tumour, pelvic inflammatory diseases, appendicitis, ectopic pregnancy or ruptured tumour</li> <li>• Be particularly alert for additional signs or symptoms of ectopic pregnancy, which is rare, but serious:             <ul style="list-style-type: none"> <li>• abnormal vaginal bleeding or no monthly bleeding, particularly if this is change from her previous bleeding pattern</li> <li>• light-headedness or dizziness</li> <li>• fainting</li> </ul> </li> </ul>
If ectopic pregnancy or another serious condition is suspected	<ul style="list-style-type: none"> <li>• Refer for immediate diagnosis and care</li> <li>• Implants can remain in place</li> </ul>
If pain is due to ovarian cyst	<ul style="list-style-type: none"> <li>• Implants can remain in place.</li> <li>• Re-assure the client that these cysts usually disappear on their own without surgery.</li> <li>• To be sure there is no problem, see the client again in about three weeks if possible</li> </ul>

## Headaches

Ordinary headaches	<p>If these headaches are ordinary:</p> <ul style="list-style-type: none"> <li>• Suggest painkillers such as ibuprofen or paracetamol</li> <li>• Reassure</li> </ul>
If migrainous headaches with aura (blurred vision, temporary loss of vision, seeing flashing lights or zigzag line)	<ul style="list-style-type: none"> <li>• If migraines with aura started or became worse after she began using the method, remove implants.</li> <li>• Help client to choose non-hormonal contraceptive method</li> <li>• Refer for care as needed</li> </ul>
If there is no pregnancy and amenorrhea is less than six weeks	<ul style="list-style-type: none"> <li>• Re-assure the client that menstruation may resume within 4–6 weeks or onset of last menses</li> <li>• Give follow-up appointment for 2–4 weeks</li> </ul>
If the client is pregnant	<ul style="list-style-type: none"> <li>• Remove the implant</li> <li>• Refer immediately for antenatal care</li> </ul>

# Intrauterine devices

## Description

Intrauterine device (IUD), also called intrauterine contraceptive device (IUCD) is a small plastic object inserted into the womb to prevent pregnancy.

## Objectives

- To explain the benefits and limitations of the IUD
- To screen clients for medical conditions which may preclude safe use of IUD
- To ensure proper insertion of IUD in clients who have no contraindications to its use
- To instruct the clients on continued and proper use of the IUD
- To identify and manage any complications

## Types of IUD

There are two types of IUDs: medicated and non-medicated.

*Non-medicated IUDs* are made of inert plastic materials (e.g. Lippes loop, SAF-coil, which are not available in Nigerian clinics now).

*Medicated IUDs* are made of plastic with copper sleeve or wire around it or impregnated with hormones, which are released in small amounts over time. These include:

- Copper T (Cu-T 380A) effective for 10-12 years
- Copper T (Cu-200) effective for 3 years
- Multiload (Cu-250) effective for 3 years
- Multiload (Cu-375) effective for 8 years

- Norgestrel - T (LNG-IUD or LNG-IUS) - contains levonorgestrel effective for 5 years.
- Lippes loop - effective indefinitely

### *Effectiveness*

Less than one pregnancy occurs per 100 women using an IUD over the first year (6–8 per 1,000 women). Over 10 years of IUD use: about two pregnancies per 100 women.

*Note:* Studies have found that TCU-380A is effective for 12 years; however, it is labelled for up to 10 years of use.

**These guidelines will focus on Copper IUDs, as they are the most common type of IUDs in Nigeria.**

## **Specific counselling issues**

### *Advantages*

- IUDs are highly effective and safe for majority of women
- They are reversible
- They are independent of intercourse
- They are private
- No day-to-day action is required
- IUDs are easily available
- They have no effect on lactation
- There is no drug interaction
- May help protect from endometrial cancer
- They are long-acting (Cu-T-380A is effective for as long as 12 years)

### *Disadvantages*

- Have common side effects (usually diminish after the first three months of use)
  - prolonged and heavy monthly bleeding
  - irregular bleeding
  - more cramps and pain during monthly bleeding



- Complications are rare, but may occur:
  - expulsion of IUD, which may lead to pregnancy
  - uterine perforation
  - PID (if inserted in woman with current gonorrhoea or chlamydia)
- IUDs do not protect against STIs/HIV/AIDS
- They require trained provider to insert and remove

*Women who can use IUDs without restriction  
(WHO Category 1)*

Women who:

- are 20 years or older
- have had children
- are within the first 48 hours postpartum
- are more than 4 weeks postpartum, regardless of breastfeeding status
- have past ectopic pregnancy
- have hypertension
- have deep vein thrombosis (DVT)
- have current or history of cardiovascular disease:
  - stroke
  - ischemic heart disease
  - multiple risk factors
- have lupus
- have headaches (migrainous and non-migrainous)
- have diabetes
- have any type of liver disease: tumour or hepatitis
- take certain drugs – anti-tuberculosis drugs eg (rifampicin, rifambutin), anti-convulsants (e.g. Phenytoin) or anti-retroviral agents (e.g. ritonavir)
- are obese
- have uterine fibroids (without distortion of uterine cavity)
- have cervical ectopy

- have current breast cancer
- have cervical intra epithelial neoplasm (CIN)
- have past pelvic inflammatory disease with subsequent pregnancy
- smoke irrespective of age
- had first trimester abortion (no sepsis)

*Women who can generally use IUDs; some follow up may be needed (WHO category 2)*

Women who:

- have menarche up to <18 years
- are nulliparous
- had second trimester abortion
- have heavy or prolonged vaginal bleeding pattern
- have endometriosis
- have severe dysmenorrhoea
- have pelvic inflammatory disease without subsequent pregnancy
- have iron-deficiency anemia
- have current STI other than gonorrhoea or chlamydia
- was diagnosed with chlamydia or gonorrhoea while already using IUD (continuation only)
- have vaginitis including *Trichomonas vaginalis* and bacterial vaginosis (initiation and continuation)
- have increased risk for STIs (e.g. have multiple sexual partners, but report consistent condom use, or live in the area with high prevalence of gonorrhoea and chlamydia )
- developed AIDS while using IUD and are not on antiretroviral therapy (continuation only)
- have HIV infection or have AIDS and are on antiretroviral therapy (clinically well)

*Use of IUDs usually not recommended in these women  
(WHO Category 3)*

Women who:

- are at increased individual risk of STIs, e.g. have multiple sex partners and don't use condoms consistently, or have partner with multiple sex partners (initiation only)
- are between 48 hours and 4 weeks postpartum
- have AIDS and not on ARV therapy or are not clinically well on ARV therapy (initiation only)
- have ovarian cancer (initiation only; women who are diagnosed with ovarian cancer while using IUD can continue while awaiting treatment)
- have benign gestational trophoblastic disease (GTD)

*Women who should not use IUDs (WHO Category 4)*

Women who:

- are pregnant
- have current PID (initiation only)
- have current STIs such as gonorrhoea and chlamydia, or purulent cervicitis (initiation only)
- have sepsis – puerperal and post-abortion
- have cervical cancer (pre-treatment)
- have endometrial cancer (initiation only; women who are diagnosed with endometrial cancer while using IUD can continue while awaiting treatment)
- have unexplained vaginal bleeding (initiation only)
- have uterine fibroids with cavity distortion
- have pelvic tuberculosis

## Equipment and materials

Ensure that the following essential items are available:

- Examination couch/insertion couch
- Light source (torch or angle-poised lamp)
- A trolley containing the following:
  - Speculum (various sizes)
  - Tenaculum ( or vulsellum)
  - Sponge holding forceps
  - Uterine sound (plastic preferably)
  - A pair of scissors
  - Sterile gloves
  - Plastic dilators
  - Straight artery forceps
  - Gallipots (2)
  - IUDs
  - Inserters and introducers (where applicable)
  - Antiseptic lotion (e.g. *Savlon*, *Hibitane*, *Purit*)
  - Sterile receiver with cover containing 1 in 2500 iodine solution or 75% alcohol
    - Bowl with lid, swabs, pads, sterile towel
- Sodium hydrochloride bleach (e.g. *Jik*, *Parozone*) 0.5%

## Time of insertion

### *Interval and postpartum*

IUD can be inserted:

- anytime during the menstrual cycle, provided pregnancy has been ruled out
- if woman is within the first 12 days of her menstrual cycle, no need for a pregnancy test or other means to rule out pregnancy

- if it is more than 12 days after the start of monthly bleeding, provider should rule-out pregnancy by other means (pregnancy checklist, pregnancy test, etc.)
- no back-up method is needed after IUD insertion regardless of timing
- immediately or within the first 12 days after abortion if there is no infection
- four to six weeks after a vaginal delivery or caesarean section (if was not inserted within the first 48 hours postpartum)

*Postpartum IUD (PPIUD) can be inserted only by trained personnel:*

- within 10 minutes post-delivery of placenta — *post-placental*
- after 10 minutes but within 48 hours of delivery — *pre-discharge*
- during caesarean section — *trans-caesarean*

## Procedure

### *Client preparation*

- Screen client for eligibility using the **screening checklist for initiation of IUCD**.
- Explain the procedure of IUD insertion to the client to ensure her cooperation and relaxation
- Demonstrate the procedure with a hand held uterus or pelvic model (where available)
- Ensure that she has emptied her bladder

### *Steps*

- Do a general physical examination of the:
  - breasts for abnormal masses and discharge
  - abdomen for masses and tenderness
- Perform a pelvic examination wearing examination sterile gloves

- external genitalia — lesions, abnormal discharge
- bimanual examination
- note shape, size, position, tenderness, and mobility of the uterus
- feel for the adnexa — whether ovaries are enlarged or fallopian tubes thickened and tender
- Perform speculum examination to exclude abnormal vaginal discharge, cervicitis. If infection is found/suspected, postpone insertion
- Take a pap smear (if none has been done in the past two years)

*If all the above are normal*

- Leave clean Cusco's/Graves speculum in the vagina
- Clean the vagina and cervix with antiseptic solution (*Savlon* or mixture of Chlorhexidine and *Savlon*)
- Grasp anterior lip of the cervix with a tenaculum (at 10 o'clock and 2 o'clock positions to minimize bleeding)
- Gently place traction on the cervix with the tenaculum to reduce the angle between the uterine body and the cervix
- While maintaining traction on the tenaculum, gently pass a uterine sound into the uterine cavity until contact is made with the fundus
- Measure the depth from the external os to the top of the fundus by withdrawing the sound and looking at the level of blood or mucus on the sound or by marking the level of the external os on the uterine sound with your index finger before withdrawing the sound.
- Load the device into the inserter
- Using the recommended insertion technique, gently introduce the loaded inserter using the withdrawal or push method (depending on IUD type)

- Observe no-touch technique in all steps, i.e.
  - load the IUD in the inserter inside the sterile package
  - clean the cervix with antiseptic
  - be careful not to touch the vaginal wall or speculum with the uterine sound or loaded IUD/inserter
  - pass both the uterine sound and the loaded IUD inserter, only once, through the cervical canal
- Withdraw the plunger and inserter tube
- Be sure to describe the steps and expected sensations to the client (you will feel a pinch, some discomfort, IUD is being put in now, etc)
- Encourage client to take slow deep breaths to help her muscles relax
- Trim the vaginal ends of the tails (string) so that approximately 5 cm (2 inches) is left beyond the external cervical os
- Release and withdraw the tenaculum
- Inspect the cervix for any bleeding from the tenaculum points and apply gentle pressure with swab on a sponge holder for a few minutes
- Remove the speculum
- Clean the client and offer sanitary pad

### **Insertion of Copper-T (Figures 32 and 33b)**

Insertion of Copper-T is done using the withdrawal technique:

- Open the Copper-T wrapper carefully
- Wear sterile gloves on both hands
- After sounding the uterus, load Copper-T as follows:
  - Bend the horizontal arms of the device so that the tips are forced into the top of the inserter
  - Adjust the movable flange along the inserter so that the distance from the tip equals the distance from the external os to the fundus as determined by uterine sound
  - Adjust the flange so that it lies in the same horizontal plane as the arms of the T

- Introduce the loaded inserter through the cervical canal and upwards until the flange rests in the external os. The tip of the inserter should be at the uterine fundus
- Release the Copper-T by holding the plunger and the tenaculum steady with left hand and withdraw the inserter a little (about half inch with the right hand). This releases the arms of the T
- Withdraw the plunger with the left hand while holding the inserter stationary with the right hand
- Push the inserter upwards until the resistance of the fundus is felt, thus ensuring fundal placement
- Then withdraw the inserter and plunger separately
- If IUD drops on the floor, or provider touches some other surface, discard the IUD and take another pack
- Trim the strings to a length of about 5 cm

### **Insertion of Multiload**

- The Multiload comes with the vertical stem already pre-loaded in the inserter. After sounding the uterus, insert as follows:
- Pick up the inserter tube bearing the pre-loaded device and adjust the moveable cervical flange to the numbered mark corresponding to the uterine sound length in cm
- Carefully insert the Multiload into the uterus until it touches the fundus and the cervical flange rests against the external os
- Withdraw the inserter to release the device into the uterine cavity
- Trim the string to about 5 cm from the external os



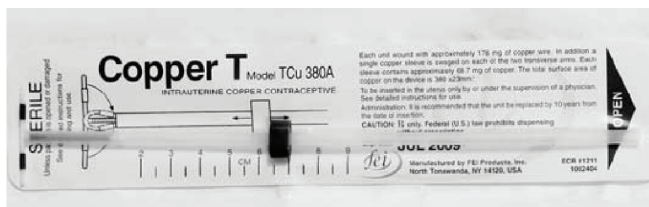


Figure 9.1: Copper T inside the pack

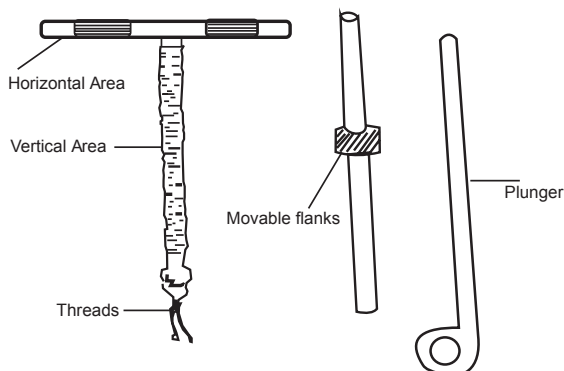


Figure 9.2: Copper T with inserter and plunger

## Insertion technique for PPIUD

### Types of techniques

- Manual
- Forceps (Kelly's forceps)

### Post-placental insertion

- Manually insert IUD or use Kelly's forceps
- IUD insertion should be done within 10 minutes of expulsion of placenta following vagina delivery

### Trans-caesarean insertion

- Done during caesarean section
- Massage the uterus until bleeding subsides

- Place the IUD at the top (fundus) of the uterine cavity manually or with a Kelly's placental or ring forceps
- Before closing the uterine incision, place the string in the lower uterine segment

*Note:* that success and effectiveness depend on high fundal placement of the IUD

#### *Pre-discharge insertion*

- Done within 48 hours after delivery while cervix is still open
- Insert IUD with Kelly's forceps or ring forceps

## **Post-insertion procedure**

- Ask the client about pain, fainting attacks, or any other discomfort
- Allow the client to rest on the couch for a few minutes and then help her down
- Record findings and give 4–6 weeks appointment

### **Post-insertion instruction for interval IUD**

Inform client that there may be increased bleeding and/or cramping for a few days and that these are normal.

*Advise her as follows:*

- Heavier menstrual bleeding, and possible bleeding between periods, is common for the first 3–6 months after insertion
- Inspect all sanitary pads or panties during menses because expulsion is more common during menstruation
- Check for string after each menstrual period (recommended, but not required if woman is uncomfortable inserting fingers into vagina)
- If at risk of STIs (e.g. multiple sexual partners, or partner with multiple partners), use condoms in addition to IUD for dual protection

- Tell the client that she may have sexual intercourse as soon as it is comfortable for her
- Report to the nearest family planning clinic if you notice any of the following:
  - P** - period late or abnormal bleeding
  - A** - abnormal pain or pain with intercourse
  - I** - infection exposure, such as gonorrhoea, abnormal discharges
  - N** - not feeling well, fever or chills
  - S** - strings missing, shorter or longer
- Inform your physician of the presence of an IUD if you are going for any gynaecological surgical procedure
- Maintain good personal hygiene

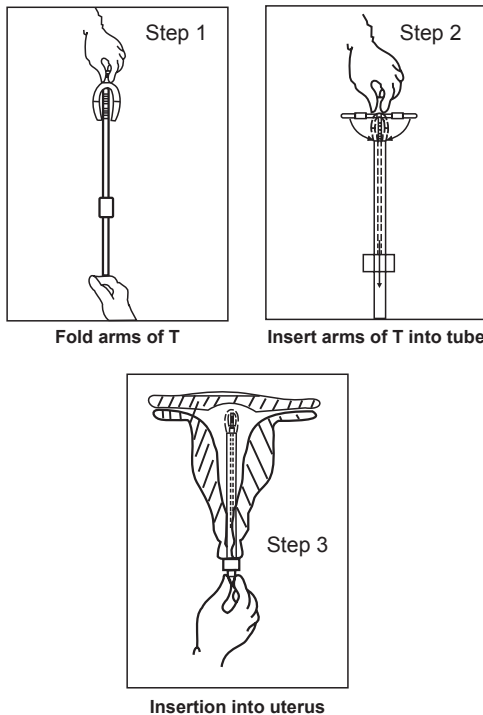


Figure 9.3: Steps in loading Copper-T

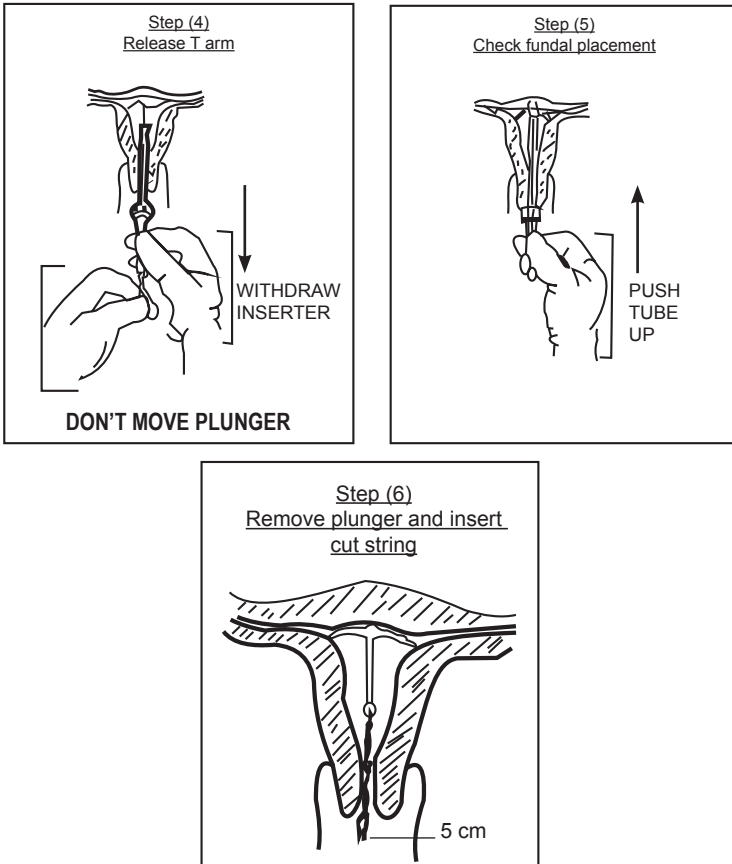


Figure 9.4: Steps in loading and inserting Copper-T

### Post-insertion instructions for PPIUD

- Tell the client the kind of IUD she has received. Show her either a sample or picture of the IUD so that she can see how it looks and how large it is
- Indicate the type of IUD boldly on the client's card
- Explain how long the IUD will prevent pregnancy
- Assure the client that the IUD has no effect on breast milk and that she can breastfeed her baby

- Tell the client that she may have sexual intercourse as soon as it is comfortable for her
- Discuss the possibility that IUD may be expelled, especially during the first few weeks after insertion
- Tell the client that she may find the IUD if it is expelled
- Explain that the client can have another IUD inserted if she chooses
- Explain that within a few weeks, the IUD strings will probably come from the womb into the vagina
- Tell her that a health care worker will shorten the strings during a follow-up visit
- She may return before her six-week check-up if the strings are a problem
- Explain how to check for the IUD strings
- Tell the client to:
  - wash her hands using soap to reduce the chances of infection
  - sit in a squatting position, or stand with one foot up on a step or ledge
  - gently insert her finger into her vagina and feel for the cervix, which feels firm, like the tip of the nose
  - feel for, but do not pull the strings because pulling it may move the IUD or cause it to be expelled
  - wait to begin checking for the strings until after six weeks postpartum
  - wash her hands again

## Follow-up

### *First visit (4–6 weeks after insertion)*

- Ask the client about her health generally
- Ask about any complaints
- Ask about variations in her menstrual cycle, including inter-menstrual bleeding or spotting, excessive blood loss, and painful menstruation
- Ask her when she last felt the strings of the device (if she checks the strings)
- Carry out abdominal and pelvic examination
- Inspect the cervix to confirm the presence of strings, if long, trim
- Note any cervical discharge
- Palpate for pelvic tenderness
- Advise client on personal hygiene

### *Schedule of subsequent follow-ups*

If all is well

- Yearly visits until the client wishes to have the device removed or the life span of the device expires
  - Copper T-200 — 3 years
  - Copper T-380A — 10-12 years
- Repeat the activities of first visit at each subsequent visit
- Encourage a pap smear every two years

## Removal of IUDs

### *Reasons for removal*

- Client desires pregnancy
- Menopause, no need for contraception
- Client desires another method of contraception
- Life of IUD has expired
- Accidental pregnancy

- Client is not able/willing to tolerate side effects
- Dyspareunia (painful intercourse)
- Partial expulsion of the device
- Cervical perforation
- Uterine perforation

### *When to remove IUDs*

Remove IUDs whenever a client insists on having it removed or when there are indications for removal. The best time to remove is during menses, because the cervix is slightly dilated, soft and removal is less uncomfortable.

### *Procedure for removal*

Prepare equipment and materials as for insertion, but include alligator forceps and retrieval hook.

### *Preparation of client*

Explain the removal procedure to the client to ensure her cooperation and relaxation.

### *Steps for IUD removal*

- Ensure that the client has emptied her bladder
- Place the client in the dorsal position with the legs flexed at the hip and knees
- With sterile-gloved hand, part the labia and gently pass a Cusco's speculum
- Visualise the cervix
- Clean the cervix and fornices **with antiseptic solution**
- Grasp the IUD strings near the external os with artery forceps and apply gentle and steady traction to remove device
- Check that no part has broken off the device
- Show device to the client
- Clean the cervix with an antiseptic solution
- Apply a perineal pad

### *Post-removal instructions*

- Explain to the client that slight vaginal spotting may continue for a few days
- If client wishes to use another method of contraception, counsel and/or initiate accordingly.

## **Difficulty in the removal of IUDs**

Trained family planning doctors should do the removal of IUDs. If traction, as described above, does not result in the removal of the device, or strings are not visible or strings are too short, proceed as follows:

- Probe the cervical canal with narrow artery forceps and attempt removal (if this fails, device is probably embedded in the endometrium)
- Explore the uterine cavity with alligator forceps, Sharman's curette, or retriever hook
- If this fails, dilate the cervix with small dilators and attempt removal again (cervical block may be necessary, or give appropriate analgesics)
- X-ray or scan with ultrasound to exclude partial or complete extrusion through the uterine wall. If this is found, explore the uterine cavity under general anesthesia and be prepared to remove a completely extruded IUD by laparoscopy or laparotomy.



## Management of problems associated with IUD

<b>Suspected perforation</b>	
<p>If perforation is suspected based on the signs such as fainting during or after insertion, pain, rapid pulse and respiration, fatigue</p>	<ul style="list-style-type: none"> <li>• Stop the insertion. If IUD was already inserted, remove it</li> <li>• Place client in a horizontal position and observe for an hour</li> <li>• Monitor vital signs (BP, pulse, respiration and temperature) every 5 to 10 minutes</li> <li>• Check for signs of intra-abdominal bleeding (haematocrit, haemoglobin)</li> <li>• If no signs of bleeding, observe for several more hours before sending home.</li> <li>• Counsel to abstain from sex for 2 weeks</li> <li>• Help her choose another method</li> </ul>
<p>If intra-abdominal bleeding is suspected</p>	<ul style="list-style-type: none"> <li>• If her vital signs are getting worse (rapid pulse, falling blood pressure, fainting) and or here haematocrit/haemoglobin are falling, refer to higher level of care without further delay</li> </ul>
<b>Bleeding changes</b>	
<p>Spotting, irregular bleeding</p>	<ul style="list-style-type: none"> <li>• Reassure that many IUD users experience irregular bleeding or spotting. This is not harmful and usually becomes less after the first several months</li> <li>• Suggest short course of non-steroidal ant-inflammatory drugs (NSAID) such as ibuprofen 400 mg or Indomethacin 25 mg 2 times a day for 5 days</li> </ul>
<p>Heavy or prolonged monthly bleeding</p>	<ul style="list-style-type: none"> <li>• Reassure that many women who use IUD experience heavy or prolonged menses. It is generally not harmful and becomes less or stops after the first several months of use</li> </ul>

## Bleeding changes

	<ul style="list-style-type: none"> <li>• For moderate short-term relief try (one at a time):             <ul style="list-style-type: none"> <li>• Tranexamic acid 1500 mg 3 times a day for 3 days, then 1000 mg once a day for 2 days, beginning when heavy bleeding starts</li> <li>• NSAID such as ibuprofen 400 mg or Indomethacin 25 mg 2 times a day for 5 days</li> </ul> </li> <li>• Provide iron tablets if possible and counsel about diet high in iron</li> </ul>
<p>If irregular, heavy or prolonged bleeding continues or starts after several months of normal bleeding or long after the IUD was inserted</p>	<ul style="list-style-type: none"> <li>• Rule out underlying condition such (e.g. infection or genital malignancy) and treat accordingly or refer to the specialist</li> <li>• She can continue using the IUD while condition is being evaluated</li> <li>• If bleeding is caused by STI or PID, she can continue using the IUD during treatment</li> </ul>

## Severe pain in lower abdomen

History and examination	<p>Assess for the signs/symptoms of PID and ectopic pregnancy</p> <ul style="list-style-type: none"><li>• Do abdominal and pelvic exam if possible to assess for PID symptoms such as abnormal vaginal bleeding or discharge, cervical discharge, tenderness in the ovaries or fallopian tubes, cervical motion tenderness</li><li>• Assess for symptoms such as:<ul style="list-style-type: none"><li>• Unusual vaginal discharge</li><li>• Fever or chills</li><li>• Bleeding after sex</li><li>• Nausea and/or vomiting</li><li>• A tender pelvic mass</li><li>• Rebound abdominal tenderness</li><li>• Abnormal vaginal bleeding or no monthly bleeding, especially if this is a change from her usual bleeding pattern</li><li>• Light-headedness, dizziness or fainting</li></ul></li></ul>
If suspicious for PID	<ul style="list-style-type: none"><li>• Begin antibiotics immediately, e.g.<ul style="list-style-type: none"><li>• Ciprofloxacin 500 mg bd x 5 days</li><li>• Doxycycline 100 mg tab orally twice daily x 7 days</li><li>• Metronidazole 400 mg tab orally twice daily x 14 days</li></ul></li><li>• Follow-up in 48 hours</li><li>• There is no need to remove IUD unless client wants to discontinue. If she wants it removed, take it out after 2-3 days of antibiotic treatment</li><li>• Instruct client to take all medication until it is finished</li><li>• Tell patient to return to clinic 4–7 days after completing antibiotics</li></ul>

### Severe pain in lower abdomen

	<ul style="list-style-type: none"><li>• Tetracycline/Doxycycline should be taken one hour before meals or two hours after meals. Avoid antacids, dairy products, e.g. milk, and mineral preparations, e.g. calcium, when taken tetracycline</li><li>• Counsel client to avoid sexual intercourse until client and partner(s) are cured; use condoms to prevent re-infections. If STI is suspected, treat partner(s)</li><li>• If IUD is removed, counsel client regarding choice of alternative family planning method until pregnancy is desired</li><li>• A client who desires another IUD can have it inserted after she and her partner were cured.</li></ul>
If suspicious for ectopic pregnancy	<ul style="list-style-type: none"><li>• Refer to a higher level provider immediately for diagnosis and care</li></ul>

### Pain and/or cramping

If pain or cramps occurred since IUD insertion (first three months) and are linked to monthly bleeding	<ul style="list-style-type: none"><li>• Re-assure client that pain and cramps are not an unusual side effect of IUD use and usually decrease over time. They are not harmful.</li><li>• Give analgesic tablets</li></ul>
If cramping continues and occurs outside of monthly bleeding	<ul style="list-style-type: none"><li>• Evaluate for underlying health condition (infection, partial expulsion of the IUD) and treat or refer</li><li>• If no underlying condition is found and cramping is unacceptable to the client, help her choose another method</li></ul>

## Missing strings

History and examination	<p>Ask the client:</p> <ul style="list-style-type: none"> <li>• Whether and when she saw the IUD come out</li> <li>• When/if she last felt the strings</li> <li>• When she had her monthly bleeding</li> <li>• If she has any symptoms of pregnancy</li> <li>• If she has used a backup method since she noticed the strings were missing</li> </ul> <p>Conduct pelvic examination to assess if IUD is still in place and for signs of pregnancy</p>
If strings are neither visible nor felt and client is not pregnant	<ul style="list-style-type: none"> <li>• Gently explore the endocervical canal with a narrow artery forceps or spiral tail extractor</li> </ul>
If tail is found	<ul style="list-style-type: none"> <li>• Bring it down gently into the vagina, taking care not to pull it</li> </ul>
If strings are not found after cervical exploration	<ul style="list-style-type: none"> <li>• Take lateral view x-ray or USS to locate the IUD</li> </ul>
If the IUD is located within the uterine cavity	<ul style="list-style-type: none"> <li>• Leave it in place and explain the client that she is still protected from pregnancy, but will not be able to check for strings. Make a note in her chart that strings are not visible.</li> </ul>
If ultrasonography or x-ray indicates that the device is in the abdominal cavity	<ul style="list-style-type: none"> <li>• Re-assure the client and refer to physician for removal by appropriate technique</li> </ul>

## Uterine pregnancy

If strings are visible	<ul style="list-style-type: none"><li>• Inform client of your findings and explain that IUD in the uterus during pregnancy increases the risk of preterm delivery or miscarriage (possibly septic) during the first or second trimester.</li><li>• Explain that if she is planning to continue the pregnancy, it is best to remove the IUD, although the removal procedure itself involves a small risk of miscarriage.</li><li>• If client consents, remove device by gently pulling the strings</li><li>• Refer for antenatal care, counsel client to return to clinic if abdominal pain and bleeding/spotting occurs</li></ul>
If strings are not visible	<ul style="list-style-type: none"><li>• Refer for ultrasound if possible to determine whether the IUD is still in the uterus.</li><li>• If it is, or if ultrasound is not possible, her pregnancy should be followed closely.</li><li>• Counsel to seek care without any delay if she experience symptoms of miscarriage/infection.</li></ul>

## IUD expulsion

History and examination	<p>Ask the client:</p> <ul style="list-style-type: none"><li>• when she last felt the strings</li><li>• her last menstrual period and duration</li><li>• if there is abdominal pain/cramping with vaginal bleeding</li><li>• if IUD was seen on pad or on pants</li></ul>
-------------------------	---

IUD expulsion	
	<p><i>Physical examination</i></p> <ul style="list-style-type: none"> <li>• Assess the breast and abdomen for signs of pregnancy</li> <li>• Perform speculum and bimanual pelvic examination to check for the presence of strings and to rule out or confirm pregnancy</li> </ul>
If strings are unusually long or stem of device is at cervical os and pregnancy is ruled out	<ul style="list-style-type: none"> <li>• Remove the IUD</li> <li>• If client wants to continue using IUD, re-insert another one and follow-up in six weeks. If not, help her choose another method</li> </ul>
If strings are unusually long or stem of device is at cervical os, and unable to exclude pregnancy	<ul style="list-style-type: none"> <li>• Remove the IUD</li> <li>• Provide barrier contraceptive</li> <li>• Ask client to return to the clinic in four weeks for re-evaluation</li> </ul>
If client reports that IUD came out	<ul style="list-style-type: none"> <li>• Discuss whether she wants another IUD or a different method.</li> <li>• If she wants another IUD, she can have one inserted at any time as long as provider is reasonably certain she is not pregnant</li> </ul>

**Note:**

Strongly consider hospitalization or referral for hospitalization with acute low abdominal pain:

- diagnosis is uncertain
- surgical emergency (e.g. appendicitis, ectopic pregnancy) is suspected
- pelvic abscess is suspected
- client is pregnant
- client is unable to follow or tolerate outpatient therapy
- client fails to respond to outpatient therapy
- outpatient follow-up after 48–72 hours cannot be arranged

# Voluntary surgical contraception

## Description

Voluntary surgical contraception (VSC) is a permanent method of contraception, which involves a minor surgical procedure performed on the client to prevent pregnancy.

## Objectives

- To provide counselling for clients desiring VSC and who do not have any contraindication
- To discuss the indications and contraindications for VSC
- To provide instructions to clients before and after VSC
- To manage complications that may arise as a result of VSC

## Types of VSC

### Vasectomy

This is the tying and cutting of the male tubes (called vas deferens) to prevent passage of spermatozoa into the seminal fluid (Figure 32). There are two approaches to the vas deferens:

- Conventional vasectomy
- No scalpel vasectomy

### *Effectiveness*

Less than one pregnancy occurs per 100 women over the first year after having the sterilization procedure (2 per 1,000).

### *Method of tying or blocking the vas deferens*

- Ligation — removal of a segment of the vas deferens and simple ligation of both ends



- **Coagulation** — electro coagulation of the mucosa at both ends

Both ligation and coagulation can be done in conjunction with a technique called fascial interposition. This involves covering one ligated or coagulated end of the vas deferens with surrounding tissue (fascia). The improved effectiveness of this practice has not been documented.

### **Tubal occlusion**

This is the blocking or cutting and tying of the fallopian tubes to prevent the passage of the ovum through the fallopian tubes to the womb (Figure 34).

#### *Effectiveness*

Less than one pregnancy occurs per 100 women over the first year after having the sterilization procedure (5 per 1,000).

#### *Method of occlusion*

- Pomeroy (commonly used)
- Parkland
- Clips, e.g. Filschie clips
- Yoon/fallope rings
- Hulka

#### *Approaches used*

- Mini laparotomy (commonly used)
- Laparoscopy
- Laparotomy

*Note:* Hysteroscopic/transcervical approaches are under development. The only transcervical sterilization method that is currently approved by regulatory agencies is **Essure™**. In most countries, including Nigeria, it is not yet available.

## Specific counselling issues

VSC should be a voluntary informed decision, therefore:

- explore and assess the client's reasons for choosing VSC
- ask the client:
  - how he/she knows about VSC
  - if he/she knows that the method is permanent
  - why he/she decides on VSC and his/her attitude to it
- discuss some changes in life situation, which could lead the client to desire a reversal of this method (e.g. divorce, re-marriage, death of partner/child or desire for a child of particular sex)
- assess the client's readiness for VSC
- ensure that he/she is eligible for this method (eligibility criteria listed further in this chapter)
- explore any indications of potential regrets such as marital instability
- ask client if partner was involved in decision making
- if the client has any doubts about VSC:
  - ask the client to think about it again and schedule another meeting for further discussion
  - in the meantime encourage client to consider an alternative method
- if client has finally chosen VSC, discuss the points listed in the consent form again
- explain the advantages and disadvantages of VSC including the fact that it is a permanent method
- inform the client that there are also highly effective reversible methods of contraception available to her
- explain the surgical procedure, including risks and benefits, preferably using audio-visual aids, such as flip charts, pelvic models, pamphlets, etc
- allow client to ask questions

- let the client know that he/she can decide against the method anytime before the procedure is performed
- document counselling and all issues discussed, then discuss issues related to the procedure
- educate the client on the need for contraception before surgery (and also for a period of time after surgery in case of vasectomy)
- inform the client about what to expect in the theatre (the medical and nursing staff, instruments that may be needed, and drugs that will be used)
- educate the client on the technique of surgical procedure and assure him/her of the safety of the procedure, using audio-visual aids
- identify and resolve any anxieties and dispel any rumours about VSC
- obtain the client's signature (or thumbprint), and a witness' on the consent form

#### *Advantages*

- VSC provides permanent contraception
- It is a highly effective method of contraception (99%)
- It is very safe
- It is cost effective over time
- It is not coitus related
- It is not client-dependent
- It promotes husband/wife involvement in family planning
- It has no adverse systemic effects
- It is one of the few available methods for men
- It does not affect the menstrual cycle or libido

#### *Disadvantages*

- VSC requires a minor operation
- There are some risks of anaesthesia, particularly if done under general anaesthesia

- There is a slight chance of failure, but the risk is much less than for other methods of contraception
- It should be considered permanent. Reversal is expensive, not widely available, requires special skills for operation and the result is uncertain
- Female sterilization may help protect against pelvic inflammatory disease and ovarian cancer
- VSC does not protect against STIs and HIV/AIDS

*End the counselling by:*

- asking the client to ask questions freely
- summarizing the important issues already discussed
- arranging appointment for surgical procedure
- providing temporary contraception if not already in use
- referring the client to a doctor if he/she has raised any issue beyond your competence and/or if he/she has accepted to have the VSC

## Eligibility criteria for sterilization

(also see Introduction)

### Female surgical sterilization

*Category A: Accept (there is no reason to deny sterilization to women with these conditions)*

- Any parity, including nulliparous
- Postpartum less than seven days or more than 42 days
- Post-abortion without complications
- History of deep venous thrombosis
- Migrainous headaches with or without aura
- History of PID with subsequent pregnancy
- Current STIs other than gonorrhoea, chlamydia or active viral hepatitis
- High risk of HIV or HIV infected, but no AIDS
- Non-pelvic TB

- Smoking, irrespective of age
- Irregular, heavy or prolonged bleeding pattern
- Sterilization concurrent with caesarean section

*Category C: Caution (the procedure is normally conducted in a routine setting, but with extra preparation and precautions)*

- Young age
- Obesity
- Hypertension; systolic 140–159 mmHg, diastolic 90–99 mmHg
- History of stroke or ischemic heart disease
- Epilepsy
- Depressive disorders
- Current breast cancer
- Uterine fibroid with or without uterine cavity distortion
- PID without subsequent pregnancy
- Diabetes without vascular complications
- Hypothyroid
- Mild (compensated) cirrhosis or liver tumours
- Sickle cell disease or iron-deficiency anaemia (Hb between 7 and 10 g/dl)
- Previous abdominal or pelvic surgery

*Category D: Delay (the procedure should be delayed until the condition is evaluated and/or corrected)*

- Postpartum 7–42 days
- Severe pre-eclampsia/eclampsia
- Prolonged rupture of membranes (24 hours or more)
- Severe antepartum haemorrhage or trauma to the genital tract
- Major surgery with prolonged immobilization
- Current ischemic heart disease
- Puerperal and post-abortal sepsis

- Current DVT/PE
- Unexplained vaginal bleeding before evaluation
- Cervical, endometrial or ovarian cancer
- Current PID, gonorrhoea, chlamydia or active viral hepatitis
- Current gall-bladder disease
- Abdominal skin infection
- Iron-deficiency anaemia (Hg less than 7 g/dl)
- Acute respiratory disease
- Systemic infection or gastroenteritis

*Category S: Special (the procedure should be undertaken in a setting with an experienced surgeon and staff, and other back-up medical support, including equipment for general anaesthesia)*

- Elevated blood pressure; systolic more than 160 mmHg, diastolic more than 100 mmHg
- Endometriosis
- Uterine perforation after delivery or abortion
- Fixed uterus due to previous surgery
- Abdominal wall or umbilical hernia
- Multiple risk factors for cardiovascular disease
- Blood pressure 160/100 mmHg or above
- AIDS
- Known pelvic TB
- Diabetes with vascular complications
- Hyperthyroid
- Severe (decompensated) cirrhosis
- Coagulation disorders
- Chronic respiratory disease (asthma, bronchitis, emphysema, lung infection)

## Male surgical contraception

*Category A: Accept (there is no reason to deny sterilization to men with these conditions)*

- High risk of HIV
- HIV infected
- Sickle cell disease

*Category C: Caution (the procedure is normally conducted in a routine setting, but with extra preparation and precautions)*

- Young age
- Depressive disorders
- Diabetes
- Previous scrotal injury
- Large varicocele/hydrocele
- Cryptorchidism

*Category D: Delay (the procedure should be delayed until the condition is evaluated and/or corrected)*

- Local scrotal skin infection
- Active STI
- Balanitis/epididymitis/orchitis
- Systemic infection/gastroenteritis
- Filariasis with elephantiasis
- Intrascrotal mass

*Category S: Special (the procedure should be undertaken in a setting with an experienced surgeon and staff, and other back-up medical support, including equipment for general anaesthesia)*

- AIDS
- Coagulation disorders
- Inguinal hernia

## Equipment and materials

As indicated by technique

## Procedure

### Client preparation

#### *Assessment*

The objectives are to:

- determine the client's fitness for VSC
- identify any conditions that may increase the risks associated with VSC
- check that preliminary screening (in particular medical history, physical examination and relevant laboratory tests, i.e. PCV, urinalysis) has been done

*Note:* A trained physician should conduct a final evaluation and it should take place where the procedure is to be performed.

### Pre-operative information

- Instruct the client not to have breakfast on the day of operation
- Ask client to be accompanied to the facility by an adult
- Re-assure the client and counsel on the safety of the procedure
- Communications should be in the language the client best understands
- Explain the steps of the operation including pre-operation medication and anesthetic/analgesics
- Explain what pain or discomfort to expect
- Discuss common and potential intra-operative complications
- Discuss possible post-operative complications and what can be done about them



- Instruct client how to use medications that may be prescribed after surgery (mainly painkillers)
- Educate the client on care of the wound after surgery
- In case of vasectomy, tell the client to use another method of contraception, e.g. condom by male partner or contraceptive pills by female partner for 3 months after surgery
- Shave client on the table (vasectomy)
- Explain the follow-up schedule and when the client should return to facility for post-operative examination

## Client monitoring

### Pre-operative monitoring

Check and record the following, which will provide the baseline data:

- Temperature
- Blood pressure
- Pulse
- Respiration

### Intra-operative monitoring

- Converse with the client continually to assess degree of analgesia (if local or regional anesthesia has been used)
- Check and record the following every five minutes:
  - Blood pressure
  - Pulse
  - Respiration

### Post-operative monitoring

- Do not leave the client alone until he/she is fully alert
- Check and record the following until client is stable:
  - Blood pressure every 15 minutes
  - Pulse every 15 minutes

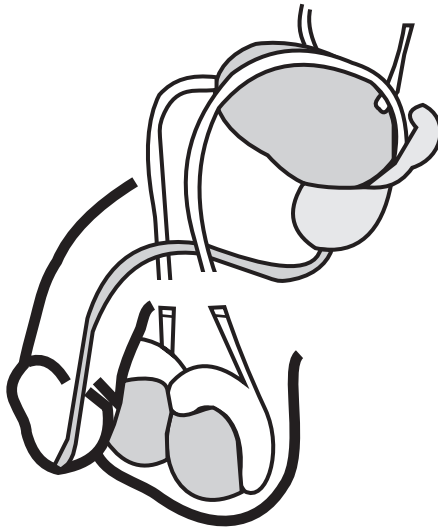
- Respiration every hour
- Temperature
- During intra-operative and post-operative periods, observe for the following signs of danger:
  - Rapid/excessive respiration
  - Restlessness
  - Rapid and/or weak pulse (over 90 beats per minute)
  - Systolic blood pressure less than 90 mmHg
  - Pallor or cyanosis
  - Respiratory rate of less than 10 per minute
  - Unresponsiveness

## Post-operative instructions

### For vasectomy

- Provide the client with scrotal support for about 48 hours to prevent discomfort or swelling
- If possible, put cold compress on the scrotum for the first 4 hours, which may decrease pain and bleeding
- Instruct the client:
  - to rest from work for about 48 hours after the procedure
  - to avoid strenuous work for about one week
  - to report for consultation if he has undue pain, not *relieved* by simple analgesics like paracetamol, or if he experiences:
    - fever
    - bleeding
    - swelling of the operation area
    - fainting
  - to resume sexual intercourse when he feels comfortable (but not before 2-3 days after surgery), using a back-up method of family planning until 3 months after surgery (relying on 20 ejaculation is not recommended)

- to come for sperm count test at three months if available and give an appointment. If sperm count is not available, he can still stop using back-up method as long as 3 months after surgery have passed
- that the stitches will dissolve by themselves and they do not have to be removed (if only catgut has been used)
- to return for follow-up appointment and removal of stitches if silk has been used on the seventh day post-surgery.



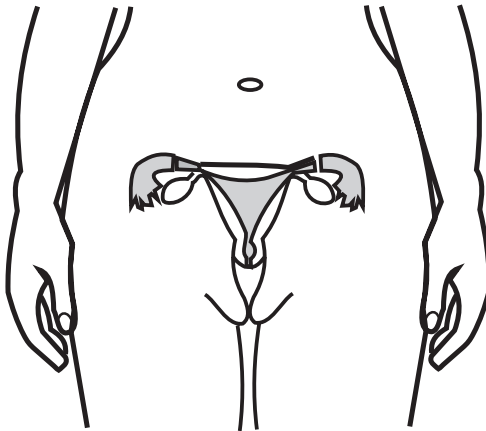
*Figure 10.1: Diagram of vas deferens after vasectomy*

### **For tubal occlusion**

Instruct the client to:

- rest at home for about 48 hours after the procedure
- avoid vigorous work and heavy lifting for a week
- keep incision clean and dry for 2 days (use towel-bath if needed)

- avoid intercourse for at least one week and until it is comfortable after that
- some abdominal pain and swelling are to be expected
- report for consultation if she has undue pain not relieved by simple analgesics like paracetamol, or if there is:
  - fever
  - bleeding from site of procedure
  - excessive swelling
  - fainting
- return for follow-up and removal of stitches if silk has been used on the seventh day after surgery
- Catgut or Vicryl stitches will dissolve by themselves and need not be removed
- If silk sutures are used it should be removed at follow-up visit.



*Figure 10.2: Diagram of the fallopian tubes after tubal occlusion*

## Follow-up visits

At follow-up visit (vasectomy and tubal occlusion):

- find out if there are any complaint from the client
- confirm that the client is satisfied with VSC and find out if the client will recommend it to others

- allow the client to ask any questions and express his/her concerns
- perform general physical examination
- inspect the operation site and remove stitches if necessary
- give appointment for semen analysis (vasectomy client) if available
- advise the client to feel free to return to the clinic any time there is any problem even before the appointment day

## Complications

- Refer clients with complications to the facility where the VSC was performed. Such complications may include:
  - Infection at the incision site with or without fever
  - Abscess
  - Severe pain in lower abdomen (ectopic pregnancy in case of female sterilization failure)
  - bleeding or blood clots
  - pain lasting for months (in case of male sterilization)

## Clients who fail to show up for surgery

- Trace client through the usual client tracking system and encourage client to report to the clinic
- Give another appointment to report to the clinic
- Discuss client's reasons for missing his/her appointment and if client has any doubts, help him/her choose another method for either on-going contraception or until client can make a decision on VSC

If client is still interested in sterilization, give another appointment for the surgery

# Post-abortion care

## Description

Post-abortion care (PAC) consists of emergency health care services, family planning counselling and referral services offered to a woman as a result of complications arising from an induced or spontaneous abortion, which could be inevitable, incomplete, or septic. Sometimes injury to the pelvic and abdominal organs may occur especially with induced abortion.

## Objectives

- To treat complications arising from abortion
- To encourage the use of a family planning method to prevent future occurrence of unwanted pregnancy

## Equipment and materials

### General

- Client record card
- Referral form
- Visual aids for counselling
- Sterile bottles
- Blood sample bottles
- Kidney dish
- Gallipots
- Sponge holding forceps
- Vaginal speculum
- Single tooth or atraumatic Tenaculum
- Dilators (size 3–14 mm)
- 10 cc syringe
- Anesthetic
- Diazepam

- Antiseptic lotions
- Disinfectants
- Gloves
- Sterile cotton wool swabs or gauze
- Blood pressure apparatus
- Stethoscope
- Torch/angle-poised lamp
- Laboratory/pathology MIS forms
- Pedal bin
- Sterile water
- Glass slide
- 95% alcohol

### **Manual vacuum aspiration (MVA) equipment**

- Vacuum syringe (single or double valve)
- Flexible cannula
- Adaptors

### **Emergency supplies**

- Atropine
- Intravenous infusion equipment and fluid
- Ambu bag with oxygen

## **Procedure**

### **Initial assessment**

Check client for the following signs and symptoms:

- Shock
- Severe vaginal bleeding
- Infection and sepsis
- Intra-abdominal injuries

### **History taking**

Refer to chapter 2

## **Physical examination**

Check the following and record findings:

- Temperature
- Pulse
- Blood pressure
- Chest (for respiratory rate, breath sounds, heart sound)
- Abdomen (for tenderness and masses)
- Pelvis (for tenderness, masses and fluid collection)
- Urinary output
- Vagina (using speculum) and cervix for foetal parts, bleeding and laceration

Conduct the following investigations:

- Urinalysis for albumin, sugar and acetone
- Blood for haemoglobin, PCV and blood group
- Pregnancy test
- Other tests such as vaginal swab for microscopy, culture and sensitivity, ultrasound scan, etc

## **MVA steps**

### *Pre-MVA procedure*

- Obtain and record complete, confidential, medical and reproductive history
- Assemble all equipment required for the MVA procedure and lay the trolley properly
- Tell the patient what will be done before commencing the procedure
- Allay the patient's fears and anxieties by providing psychological and emotional support

### *MVA procedure*

- Cover the client with drapes
- Clean the perineum, vulva and vagina with antiseptic swabs



- Perform bimanual pelvic examination to confirm uterine size, position, and degree of cervical dilation
- Check the vagina for tissue fragments and remove if any
- Insert the vaginal speculum
- Apply antiseptic solution to the cervix twice, particularly the os
- Apply Tenaculum or Vulsellum forceps on anterior lip of the cervix
- Administer paracervical block by injecting local anaesthetic like lignocaine into the paracervical tissues at 4 and 10 o'clock positions. An additional injection is often made at 12 o'clock position where the Tenaculum is placed
- Wait 3–5 minutes for the anaesthetic to take effect before proceeding
- While holding the cervix steady, gently insert the cannula through the cervix into the uterine cavity
- Create vacuum into the Karman's syringe by closing the valve and withdrawing the plunger
- Attach the prepared syringe to the cannula by holding the end of the cannula in one hand and the syringe in the other
- Evacuate the contents of the uterus by rotating the cannula syringe and gently moving the cannula slowly back and forth within the uterine cavity
- In the course of this procedure, re-assure the client and encourage her to take deep breaths. If she feels cramping, inform her that the procedure will soon be over
- Rotate the cannula and syringe back and forth until the uterus has been emptied
- Inspect tissues removed from the uterus for quantity and presence of products of conception (POC) to ensure complete evacuation
- When foam is seen in the cannula and a grating sensation is perceived through the syringe, the procedure has been completed

- Withdraw the cannula and syringe
- Remove Tenaculum or Vulsellum forceps
- Remove vaginal speculum gently
- Perform bimanual examination to check the size and firmness of the uterus
- Check for bleeding
- Complete the record of the procedure

#### *Post-MVA procedure*

- Monitor the woman's recovery and if no complications occur, discharge her shortly after procedure
- Provide family planning counselling and encourage the client to make informed choice
- Instruct the client to return for follow-up visit two weeks after procedure
- Instruct the client to come to the clinic if any problem arises

### **Counselling tips**

- Be compassionate, emphatic and non-judgmental
- Ensure privacy and confidentiality
- Instruct the client to abstain from sexual intercourse until post-abortal bleeding stops and symptoms are resolved
- Inform the client that she can become pregnant again before her next period if she has unprotected sex
- Educate the client on her medical condition and use the opportunity to inform her of future occurrences
- Encourage the client to commence a preferred chosen method of contraception

## Management of post-abortion complications

Complication	Signs and symptoms	Management
Shock	<ul style="list-style-type: none"> <li>• Fast, weak pulse (110/minute or greater)</li> <li>• Low blood pressure (systolic less than 90 mmHg)</li> <li>• Pallor (of inner eyelids, around mouth or of palms)</li> <li>• Perspiring/ sweating (skin cold and clammy)</li> <li>• Rapid breathing (respiration 30 per minute or greater)</li> <li>• Anxiety, confusion, or unconsciousness</li> <li>• Scanty urine output (less than 30 ml per hour)</li> </ul>	<ul style="list-style-type: none"> <li>• Make sure airway is open</li> <li>• Give oxygen at 6–8 litre/minute (mask or nasal cannula)</li> <li>• Give IV fluids (<i>Do not give fluids by mouth</i>)</li> <li>• Raise the patient's legs or foot off the bed</li> <li>• Keep the patient warm</li> <li>• Check haemoglobin and if less than 5 gm/100ml, transfuse with blood</li> <li>• For those who do not accept blood transfusion or where blood is not readily available, plasma expanders such as Haemacel or Dextran will be good substitutes</li> <li>• Administer antibiotic therapy if shock is due to sepsis</li> <li>• Refer patient with extensive trauma</li> </ul>

Complication	Signs and symptoms	Management
Severe vaginal bleeding	<ul style="list-style-type: none"> <li>• Heavy, bright red vaginal bleeding with or without clots</li> <li>• Blood-soaked sanitary pads, towel or clothing</li> <li>• Pallor of inner eyelids around mouth or of palms</li> </ul>	<ul style="list-style-type: none"> <li>• Check vital signs</li> <li>• If general conditions are satisfactory, check the cervix and if open, complete the process of abortion by carrying out an evacuation of the uterus using MVA</li> <li>• If bleeding continues, examine for genital tract injury and repairs if possible, otherwise give an oxytocic drug and bimanually massage the uterus</li> <li>• Check completeness of the evacuation</li> <li>• Give oxygen at 6–8 litres/minute</li> <li>• Give intravascular fluids</li> <li>• If bleeding still continues, resuscitate patient and REFER</li> </ul>
Infection and sepsis	<ul style="list-style-type: none"> <li>• Chills, fever, sweat (flu-like symptoms)</li> <li>• Foul smelling vaginal discharge</li> <li>• Abdominal pain</li> </ul>	<ul style="list-style-type: none"> <li>• Give tetanus toxoid, if the patient has been exposed to tetanus or her vaccination history is uncertain</li> <li>• Monitor urinary output</li> </ul>

Complication	Signs and symptoms	Management
Infection and sepsis	<ul style="list-style-type: none"> <li>• Distended abdomen</li> <li>• Rebound tenderness</li> <li>• Low blood pressure</li> <li>• Prolonged bleeding</li> </ul>	<ul style="list-style-type: none"> <li>• Treat patient for one week, but change IV drugs to oral once patient's condition improves</li> <li>• REFER, if necessary</li> </ul>
Intra-abdominal injuries	<ul style="list-style-type: none"> <li>• Abdominal pain, cramping</li> <li>• Distended abdomen</li> <li>• Decreased bowel sounds</li> <li>• Tense and hard abdomen</li> <li>• Rebound tenderness</li> <li>• Nausea/vomiting</li> <li>• Shoulder pain</li> <li>• Fever</li> <li>• Shock</li> </ul>	<ul style="list-style-type: none"> <li>• Check vital signs and raise patient's legs</li> <li>• Make sure airway is open</li> <li>• Give IV fluids (<i>Do not give by mouth</i>)</li> <li>• Transfuse with blood if haemoglobin is less than 5 gm/100 ml</li> <li>• Give IV or IM analgesic for pain</li> <li>• If there are signs of infection, give antibiotics</li> <li>• Give tetanus toxoid if at risk</li> <li>• Measure urine output</li> <li>• Obtain upright abdominal x-ray</li> <li>• All suspected abdominal injuries should be referred to the gynaecologist</li> </ul>

# Sexually transmitted infections and HIV/AIDS

## Description

Sexually transmitted infections (STIs) are a group of communicable diseases that are transferred predominantly by sexual contact. STIs can cause pain and infertility, and if left untreated, death.

## Objectives

- To educate all clients about the risks of sexually transmitted infections including HIV/AIDS
- To assist clients in choosing an appropriate contraceptive method that will reduce the risks of sexually transmitted infections including HIV/AIDS
- To counsel clients about HIV/AIDS
- To recognize, treat and/or refer clients with complaints suggestive of sexually transmitted infections including HIV/AIDS

## Types of STIs

- Gonorrhoea
- Chlamydia
- Candidiasis
- Trichomoniasis
- Gardnerella vaginalis/bacterial vaginosis
- Chancroid
- Syphilis
- Lymphogranuloma venereum (LGV)
- Herpes genitalis

- Genital warts (*Condylomata acuminata*)
- Human immuno-deficiency virus (HIV)/acquired immune deficiency syndrome (AIDS)

## Equipment and materials

The following equipment and materials are basic requirements for STI service units:

- Writing table with chairs for the provider and client in a place where privacy is assured
- Examination couch, preferably with facilities for putting client in lithotomy position
- Trolley with
  - top shelf containing a covered tray with Sims and Cusco's specula, sponge-holding forceps
  - bottom shelf containing a covered tray with bowls and kidney dishes
- Examination light/angel poised lamp/spot lamp or torch
- Examination gloves (disposable examination gloves will suffice)
- Specimen bottles for blood (VDRL test) and urine bacteriology tests
- Sterile swab sticks
- Syringes and needles
- Microscope slides and cover slips
- Microscope for examination of wet preparations and for urine microscopy
- Forms for:
  - all the tests listed above
  - drug prescriptions
  - contact tracking
- Information, education and communication (IEC) materials for counselling.

## Procedure for managing STI patients

- Receive the client, introduce yourself, and make him/her feel at ease
- Ensure privacy and confidentiality
- Ask the client to describe his/her complaints
- Find out the client's knowledge about the:
  - cause of the condition he/she has
  - mode of spread of the condition
  - importance of treatment compliance
  - importance of treatment of sexual partners including husband or wife
- Examine the client and perform any necessary tests, e.g. urethral and cervical swabs
- Educate the client based on information given above
- Encourage the client to ask questions
- Counsel, provide treatment, or refer to appropriate center where client can be treated
- Instruct the client to abstain from intercourse until three days after commencement of treatment. However, if client chooses to have intercourse, she should use a condom
- Remind client that condoms and spermicides will help prevent re-infection
- Give a follow-up appointment
- Give STI contact tracking forms if there are any, or invite contacts through the client
- Encourage personal hygiene.



# Some common sexually transmitted infections

## Sexually transmitted infections with discharges

Disease	Signs and symptoms	Management
Gonorrhoea	<p><i>Men</i></p> <ul style="list-style-type: none"> <li>• Purulent urethral discharge, pain during urination, frequency of urination</li> </ul>	<ul style="list-style-type: none"> <li>• Take swab of urethral discharge for microscopy, culture and sensitivity</li> <li>• If possible, request VDRL and encourage HIV screening</li> </ul>
	<p><i>Women</i></p> <ul style="list-style-type: none"> <li>• Abnormal vaginal discharge, pain during urination, prolonged menstruation or heavy bleeding</li> <li>• Often there are no symptoms</li> </ul>	<ul style="list-style-type: none"> <li>• Perform speculum examination and take an endocervical and urethral swab for microscopy, culture and sensitivity</li> <li>• Conduct digital examination</li> <li>• If possible request VDRL and encourage HIV screening</li> </ul> <p><i>Drugs</i></p> <ul style="list-style-type: none"> <li>• Spectinomycin, 2 gm IM stat (Complicated cases 2 gm IM twice daily for 7 days)</li> </ul> <p><i>Or</i></p> <ul style="list-style-type: none"> <li>• Ciprofloxacin 500 mg stat (not for pregnant women, children and adolescents)</li> </ul>

Disease	Signs and symptoms	Management
		<ul style="list-style-type: none"> <li>• Amoxicillin (Amoxil) 3.0 gm</li> </ul> <p><i>Or</i></p> <ul style="list-style-type: none"> <li>• Ofloxacin (Tarivid) 40 mg tabs stat</li> </ul> <p><i>Or</i></p> <ul style="list-style-type: none"> <li>• IM Rocephin (Ceftriaxone) 125 gm stat</li> </ul> <p><i>Or</i></p> <ul style="list-style-type: none"> <li>• Cefixim 450 mg orally stat</li> </ul> <ul style="list-style-type: none"> <li>• Ask the client to abstain from sexual intercourse or use a condom during this period of treatment and return to clinic after 7 days</li> <li>• Issue STI contact tracking form, because you may need to treat contact</li> <li>• If there is no improvement, refer to a specialist (STI) clinic</li> </ul>
Chlamydia (mucopurulent discharge)	<p><i>Men</i></p> <ul style="list-style-type: none"> <li>• Mucoid to purulent urethral discharge, painful urination or urinary frequency</li> </ul>	<ul style="list-style-type: none"> <li>• Take swab of urethral discharge for microscopy, culture and sensitivity</li> <li>• If possible, request VDRL and encourage HIV screening</li> </ul>

Disease	Signs and symptoms	Management
Chlamydia (mucopurulent discharge)	<ul style="list-style-type: none"> <li>• Sometimes there is no symptom</li> </ul> <p><i>Women</i></p> <ul style="list-style-type: none"> <li>• Yellow mucopurulent discharge from the cervix</li> <li>• Often the discharge may be regarded as normal by client</li> </ul>	<ul style="list-style-type: none"> <li>• Perform speculum and digital pelvic examination to detect adnexal tenderness and/or masses</li> </ul> <p><i>Drugs</i></p> <ul style="list-style-type: none"> <li>• Tetracycline caps 500 mg qid x 7 days</li> </ul> <p><i>Note:</i> Clients should avoid milk or milk products two hours before and after taking tetracycline</p> <p><i>Or</i></p> <ul style="list-style-type: none"> <li>• Doxycycline caps 100 mg bd x 10–14 days</li> <li>• Erythromycin 500 mg 6 hourly x 7 days</li> <li>• Azithromycin 1 gm stat</li> </ul> <p><i>Note:</i> Doxycycline and tetracycline are contraindicated during pregnancy.</p>

Disease	Signs and symptoms	Management
Non-gonococcal urethritis	<ul style="list-style-type: none"> <li>• Dysuria, urethral or cervical mucopurulent or mucoid discharge, frequency of urination</li> <li>• Sometimes the only complaint is increased vaginal discharge in women</li> </ul>	<ul style="list-style-type: none"> <li>• Treat as outlined under each of the following causes: <ul style="list-style-type: none"> <li>❖ Chlamydia infection</li> <li>❖ Trichomoniasis</li> </ul> </li> <li>• If in doubt of diagnosis, give Doxycycline caps 100 mg bd x 7 days or refer</li> </ul>
Pelvic inflammatory disease (PID) (infection of internal genital organs like the cervix, uterus, tubes, ovaries and other adjacent tissues)	<ul style="list-style-type: none"> <li>• Usually there is pain and tenderness in the lower abdomen with or without vaginal discharge and fever</li> <li>• It often occurs in the first 5–10 days of menstruation</li> <li>• Painful sexual intercourse (dyspareunia)</li> </ul>	<ul style="list-style-type: none"> <li>• A pelvic examination may reveal cervical discharge, spotting, or tenderness with or without tender masses in the pelvis</li> <li>• If facilities are available, laparoscopy could be performed and swab taken from the pouch of Douglas</li> <li>• <i>Discourage self medication with antibiotics</i></li> </ul> <p>For mild cases, give the following drugs:</p> <ul style="list-style-type: none"> <li>• Ampicillin caps 500 mg qid or Septrin 960mg bd x 5 days</li> </ul>

Disease	Signs and symptoms	Management
<p>Causative organisms include <i>Gonorrhoea</i>, <i>Chlamydia</i>, gram negative bacteria like <i>E. coli</i>, and anaerobic bacteria</p>		<p>Or Doxycycline 100mg b.d x 7 days And</p> <ul style="list-style-type: none"> <li>• Metronidazole (Flagyl) 200–400 mg tds x 7 days</li> </ul> <p>Or</p> <ul style="list-style-type: none"> <li>• Ofloxacin (Tarivid) tabs 200 mg bd x 5 days</li> <li>• Treat sexual partner with the same drug regimen if chlamydia or gonorrhoea is suspected</li> <li>• Ask client to return to the clinic after seven days or earlier if no improvement</li> </ul> <p><i>Refer the client to a hospital if:</i></p> <ul style="list-style-type: none"> <li>• you are in doubt of findings or diagnosis</li> <li>• you suspect ectopic pregnancy or appendicitis</li> <li>• there is pelvic mass or abscess</li> <li>• the patient is severely ill</li> </ul>
<p>Candidiasis</p>	<ul style="list-style-type: none"> <li>• Thick, whitish curd-like vaginal discharge accompanied by vaginal discomfort and vulval itching</li> <li>• Sometimes there is pain during coitus or urination</li> </ul>	<ul style="list-style-type: none"> <li>• Perform pelvic examination including taking a high vaginal swab for wet microscopy and to exclude the presence of foreign body or malignancy of the cervix</li> </ul>

Disease	Signs and symptoms	Management
Candidiasis	<ul style="list-style-type: none"> <li>In the male there may be itching of the genitals and white fluid under foreskin (if not circumcised)</li> </ul>	<ul style="list-style-type: none"> <li>Check urine for sugar to screen for diabetes mellitus</li> </ul> <p><i>Treat as follows:</i></p> <ul style="list-style-type: none"> <li>Canesten (clotrimazole) pessaries daily x 6 days</li> </ul> <p><i>Or</i></p> <ul style="list-style-type: none"> <li>Nystatin pessaries bd x 10–14 days</li> <li>Paint vagina with 1% aqueous solution of Gentian violet daily x 14 days (demonstrate to client how to apply)</li> </ul> <p><i>Or</i></p> <ul style="list-style-type: none"> <li>Miconazole or ketoconazole or pessaries if available</li> <li>For men, Nystatin cream bd x 7 days</li> </ul>
Trichomoniasis	<ul style="list-style-type: none"> <li>Copious, watery and frothy creamy or greenish yellow vaginal discharge associated with itching and painful urination</li> <li>Vulva has a foul smell from discharge</li> </ul>	<ul style="list-style-type: none"> <li>Perform pelvic examination including speculum examination and take a high vaginal swab for microscopy</li> <li>Exclude foreign body or malignancy of cervix</li> </ul>

Disease	Signs and symptoms	Management
Trichomoniasis		<p><i>Treat as follows:</i></p> <ul style="list-style-type: none"> <li>• Metronidazole (Flagyl) 2 gm stat or 400-500 mg tds x 7 days (client should avoid alcohol during medication)</li> </ul> <p><i>Or</i></p> <ul style="list-style-type: none"> <li>• Tinidazole 2 g orally stat or 500 mg bd for 5 days</li> <li>• During pregnancy use clotrimazole 100 mg intravaginally at bed time for 7 days. This will give symptomatic relief and some cure</li> <li>• Treat contacts</li> </ul> <p><i>Note:</i> Metronidazole is generally not recommended for use in the first trimester of pregnancy</p>
Gardnerella vaginalis	<ul style="list-style-type: none"> <li>• Watery vaginal discharge with fishy odour</li> <li>• Itching may be present</li> </ul>	<ul style="list-style-type: none"> <li>• Perform digital and speculum pelvic examination</li> <li>• Exclude the presence of foreign bodies or malignancies of the genital tract</li> <li>• Take a high vaginal swab for microscopy</li> </ul>

Disease	Signs and symptoms	Management
Gardnerella vaginalis		<p><i>Treat as follows:</i></p> <ul style="list-style-type: none"> <li>• Metronidazole tabs 400 mg bd orally for 7 days <b>or</b> Metronidazole 2mg orally stat <b>or</b> metronidazole 0.75% gel intravaginally bd for 5 days.</li> </ul> <p>Or</p> <ul style="list-style-type: none"> <li>• Clindamycin 300mg orally bd for 7 days <b>or</b> clindamycin 2% vagina cream 5g intravaginally at bed time for 7 days.</li> <li>• Advise client to return if symptoms persist</li> <li>• Sexual partner may be treated if there is recurrence</li> <li>• Advise client to use condom to prevent future infections</li> </ul>



Algorithms for the management of STI with discharge are given below

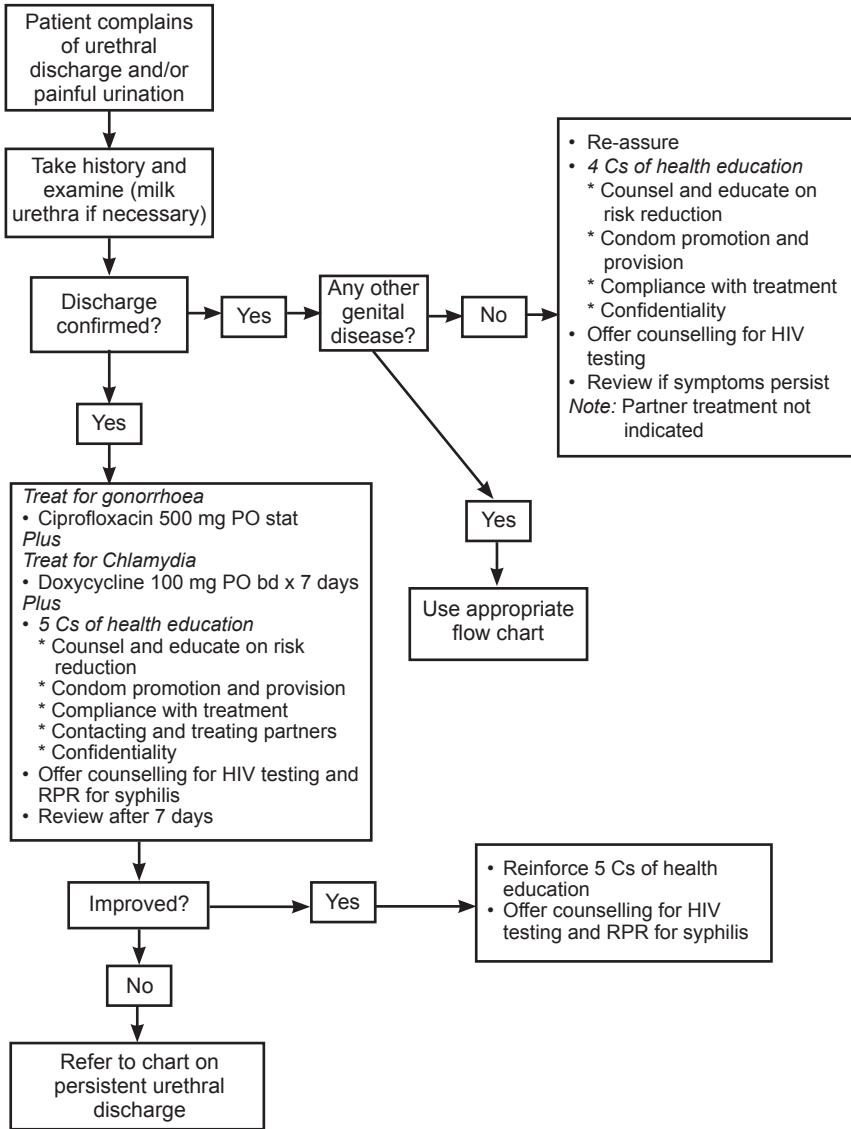
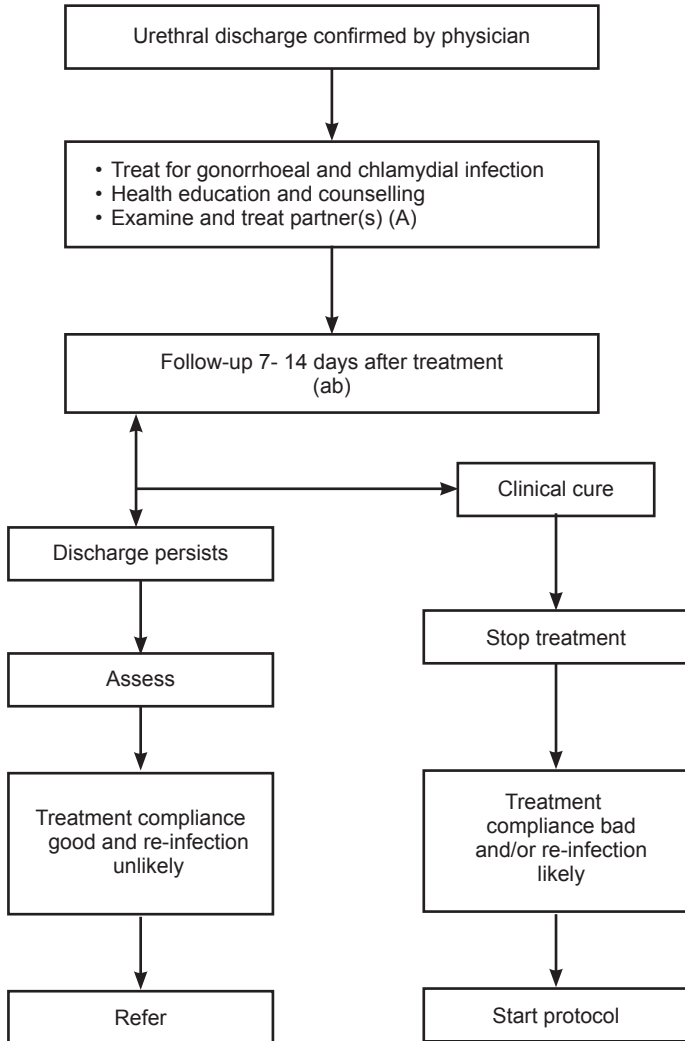


Figure 12.1: Flow chart for male urethral discharge





*Figure 12.3: Flow chart for management of genital discharge (syndromic management of urethral discharge in the absence of laboratory support)*

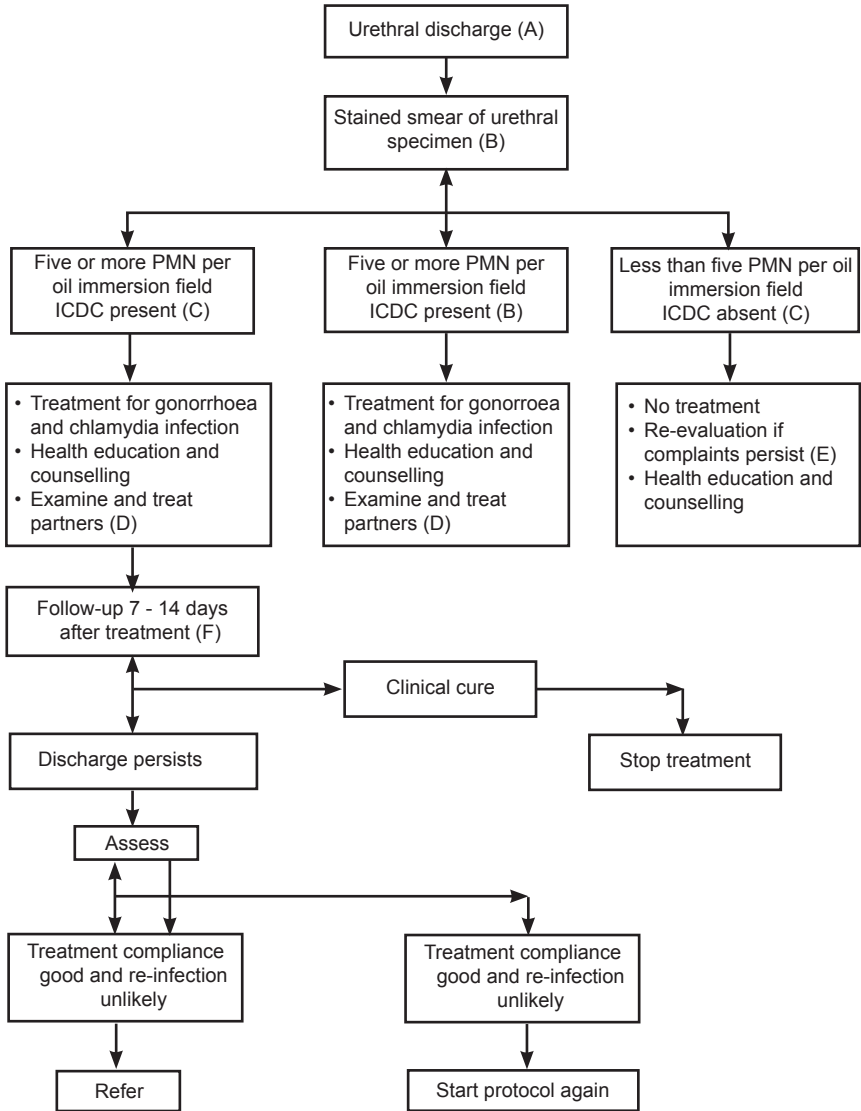


Figure 12.4: Flow chart for management of genital discharge (syndromic management of urethral discharge in the presence of laboratory support)

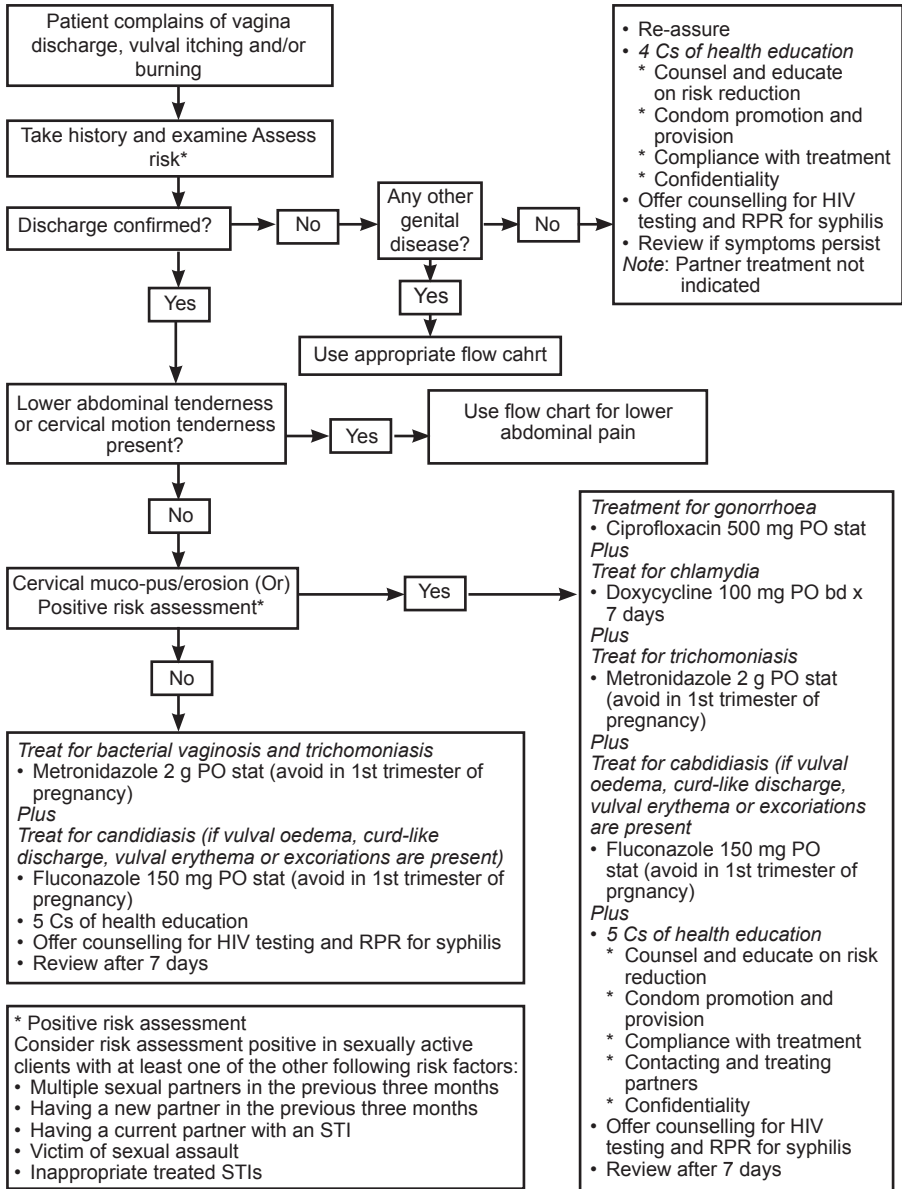
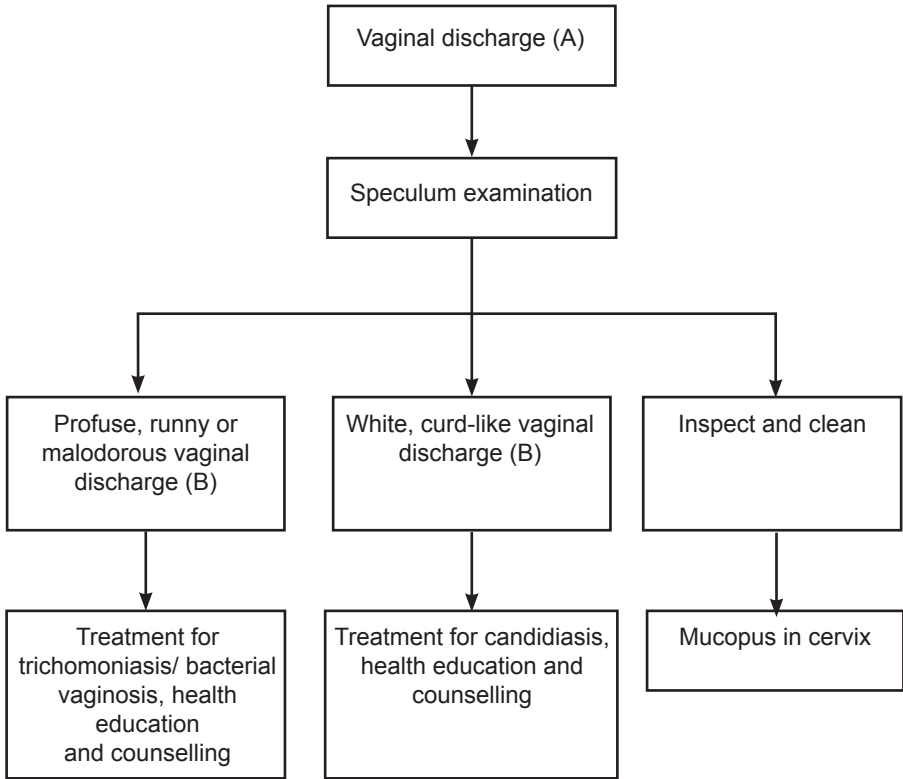


Figure 12.5: Flow chart for management of vaginal discharge (with laboratory support)



*Figure 12.6: Flow chart for management of vaginal discharge (speculum examination possible but no laboratory support)*

**Note:**

- Notification and treatment of female partners of men with urethritis is of the highest priority because it is one of the best ways of identifying women at high risk of having asymptomatic gonococcal and chlamydia infections.
- Polymorphonuclear leukocytes (PMN); intracellular diplococci (ICDC); magnification of oil immersion objective is x100.

- Patient should be advised to hold urine for at least three hours before the return visit.
- Patient may be advised to return only if the symptoms persist and insist on using condom.
- If vaginal discharge is accompanied by lower abdominal pain or pain on moving cervix, use the appropriate “lower abdominal pain” algorithm.
- In addition, the pH paper test can be used: if pH is lower than 4.5, treat for candidiasis; if pH is higher than 4.5, treat for trichomoniasis/bacterial vaginosis.
- In the absence of a confirmed diagnosis, the decision to notify partner(s) should take into account local cultural and epidemiological factors.
- Patient may be advised to return only if symptomatic.

## Sexually transmitted infections with ulcers

Disease	Signs and symptoms	Management
Chancroid	<ul style="list-style-type: none"> <li>• Client complains of the following about 1-8 days after intercourse:</li> <li>• Single or multiple soft superficial, painful ulcers with ragged edges on the prepuce or shaft of penis in the male and vulva, labia or vagina in the female, or anus in male or female</li> <li>• Usually unilateral lymph node enlargement occurs and may progress to form an abscess</li> </ul>	<ul style="list-style-type: none"> <li>• Conduct a pelvic examination including speculum examination to exclude other STIs and to take specimen for culture and sensitivity if your centre has facilities</li> <li>• Counsel for HIV screening and send appropriate blood sample</li> <li>• Give the following treatment:               <ul style="list-style-type: none"> <li>• Ciprofloxacin 500 mg orally bd x 3 days</li> <li>Or</li> <li>• Erythromycin Base 500 mg orally qid for 7 days</li> <li>Or</li> <li>• Azithromycin 1gm orally stat</li> <li>Or</li> <li>• Ceftriazone 250 mg IM stat</li> </ul> </li> <li>• Inguinal lymph node enlargement/abscess should be aspirated</li> <li>• Advice contact to be treated</li> <li>• Follow-up visit is necessary to ensure that infection is clear</li> <li>• Advise on the use of</li> </ul>



Disease	Signs and symptoms	Management
		condoms to prevent the spread of infection
Syphilis	<p><i>Primary</i></p> <ul style="list-style-type: none"> <li>• Presence of a painless shallow ulcer with indurated (firm) base</li> <li>• The ulcer may heal by itself</li> <li>• There may be mild fever, headache and general ill health</li> </ul> <p><i>Secondary</i></p> <ul style="list-style-type: none"> <li>• Skin rash more on the chest, abdomen and the axilla and groin where they may enlarge to form condylo-mata lata</li> <li>• Ulcers of mucous membranes especially of genitals, mouth, pharynx and larynx</li> <li>• Enlargement of lymph nodes of the neck or axilla with mild fever</li> </ul> <p><i>Tertiary or latent</i></p> <ul style="list-style-type: none"> <li>• Usually there are no symptoms, but occurs 3–10 years after primary syphilis</li> </ul>	<ul style="list-style-type: none"> <li>• Primary and secondary syphilis can be confirmed by dark field or fluorescent microscopy of specimen material from the ulcer on the genitalia, lymph node or other lesions</li> <li>• If facilities are available, serological tests for syphilis like VDRL, TPHA become useful 10 days after onset of lesions</li> <li>• Counsel for HIV screening and send appropriate blood sample</li> </ul> <p>Treatment</p> <ul style="list-style-type: none"> <li>• IM benzathine penicillin, 2.4 mega units single dose in each buttock</li> </ul> <p>Or</p> <ul style="list-style-type: none"> <li>• Aqueous procaine penicillin, 600,000–1,200,000 units daily x 10 days, by deep intramuscular injection</li> </ul>

Disease	Signs and symptoms	Management
	<ul style="list-style-type: none"> <li>• Neurosyphilis or tabes dorsalis or cardiovascular system involvement like aortic aneurysm may be present</li> </ul>	<p>For clients with penicillin allergy, give any of the following:</p> <ul style="list-style-type: none"> <li>• Doxycycline (Vibramycin) tabs 100 mg bd x 15 days</li> </ul> <p>Or</p> <ul style="list-style-type: none"> <li>• Tetracycline hydrochloride caps 500 mg qid x 15 days</li> </ul> <p>Or</p> <ul style="list-style-type: none"> <li>• Erythromycin tabs 500 mg qid x 15 days</li> </ul> <p>For pregnant patients</p> <ul style="list-style-type: none"> <li>• Treat with Erythromycin or Penicillin as above and treat their newborn babies with Penicillin</li> </ul> <p>For latent syphilis, use:</p> <ul style="list-style-type: none"> <li>• Procaine Penicillin, 2.4 mega units daily with Probenecid 500 mg qid for 10 days, followed by IM Benzathine penicillin 2.4 mega units weekly x 3 weeks</li> <li>• Serological test for cure should be performed at 3, 6, 12 and 24 months</li> <li>• Client and partner(s) should abstain from</li> </ul>

Disease	Signs and symptoms	Management
		<p>sexual intercourse till they are cured or should use condoms</p> <ul style="list-style-type: none"> <li>• Advise the use of condoms to prevent future STI infections</li> </ul> <p>If in doubt, refer to a medical officer or specialist centre</p>
Lymphogranuloma venereum	<p><i>Primary lesion</i></p> <ul style="list-style-type: none"> <li>• Client may have single or sometimes multiple painless vesicles and/or ulcer, which may be unnoticed or overlooked by the client</li> </ul> <p><i>Latent lesions</i></p> <ul style="list-style-type: none"> <li>• Within 4–6 months of onset there may be inguinal lymph node enlargement or abscess or ulcers</li> </ul>	<ul style="list-style-type: none"> <li>• Examine the inguinal region (loin) for swellings (lymph nodes enlargement or abscess) and ulcers</li> <li>• Counsel for HIV screening and send appropriate blood sample</li> </ul> <p>Give any of the following:</p> <ul style="list-style-type: none"> <li>• Tetracycline caps 500 mg qid x 21 days</li> </ul> <p>Or</p> <ul style="list-style-type: none"> <li>• Doxycycline caps 100 mg bd x 21 days</li> </ul> <p>Or</p> <ul style="list-style-type: none"> <li>• Erythromycin, tabs 500mg q.i.d. x 21 day</li> <li>• Trace and treat sexual contacts</li> <li>• Advise clients to use condoms during period of treatment. Counsel</li> </ul>

Disease	Signs and symptoms	Management
		for HIV screening and send appropriate blood sample
Herpes	<ul style="list-style-type: none"> <li>• Single or multiple vesicles on the penis in the male, or the vulva, vagina, and cervix in the female, or anal vesicles may rupture to form painful superficial ulcers, which may heal spontaneously</li> <li>• Sometimes inguinal lymph node enlargement or general ill health may occur</li> <li>• Recurrent infections are frequent</li> </ul>	<ul style="list-style-type: none"> <li>• No definite medication is currently available for herpes infection</li> </ul> <p>For symptomatic treatment, the following are useful:</p> <ul style="list-style-type: none"> <li>• Keep lesions clean and have sitz bath three times daily</li> <li>• Ampicillin or Ampiclox caps 500 mg qid x 5–7 days may prevent bacterial infection</li> <li>• Acyclovir tabs 200 mg 5 times daily x 10 days may limit infection (do not use during pregnancy)</li> <li>• Topical application of Acyclovir may be beneficial</li> <li>• Advise client to limit number of sexual partners and encourage the use of condoms</li> <li>• Counsel for HIV screening and send appropriate blood sample</li> </ul>

Disease	Signs and symptoms	Management
Genital warts (condylomata acuminata)	<ul style="list-style-type: none"> <li>• Variable number of soft fleshy growth of different sizes usually found around the anus and perineum or vulva and penis</li> <li>• May grow rapidly</li> </ul>	<ul style="list-style-type: none"> <li>• Apply 10–20% podophyline and wash off after 1–4 hours</li> <li>• If there is no appreciable change after four weeks, refer to a specialist centre for cryotherapy, electrocautery, or laser treatment</li> </ul>
Granuloma liguinale (don-ovanosis)	<ul style="list-style-type: none"> <li>• Single or multiple soft superficial, painful ulcers with ragged edges on the prepuce or shaft of penis in male, or on vulva, labia or vaginal in the female appearing 1–8 days after sexual intercourse</li> <li>• Usually unilateral inguinal lymph node enlargement occurs and may progress to abscess</li> </ul>	<ul style="list-style-type: none"> <li>• Conduct pelvic examination including speculum examination to exclude other STIs and to take specimen for culture and sensitivity if your centre has facilities</li> </ul> <p><i>Give the following treatment:</i></p> <ul style="list-style-type: none"> <li>• Septrin 960mg orally bd for 21 days</li> </ul> <p>Or</p> <ul style="list-style-type: none"> <li>• Erythromycin orally 500 mg qid for 21 days</li> </ul> <p>Or</p> <ul style="list-style-type: none"> <li>• Ciprofloxacin 750 mg bd for 3 weeks</li> </ul> <p>Or</p> <ul style="list-style-type: none"> <li>• Streptomycin IM 1 gm for 7 days</li> <li>• Inguinal lymph node enlargement/ abscess should be aspirated</li> </ul>

Disease	Signs and symptoms	Management
		<ul style="list-style-type: none"> <li>• Advise contacts to be seen and treated</li> <li>• Follow-up visit is necessary to ensure infection is clear</li> <li>• Advise the use of condoms to prevent the spread of infection</li> <li>• Counsel for HIV screening</li> </ul>

Algorithms for management of STIs with ulcers, inguinal swelling and bubo, genital warts and lower abdominal pain are given below.

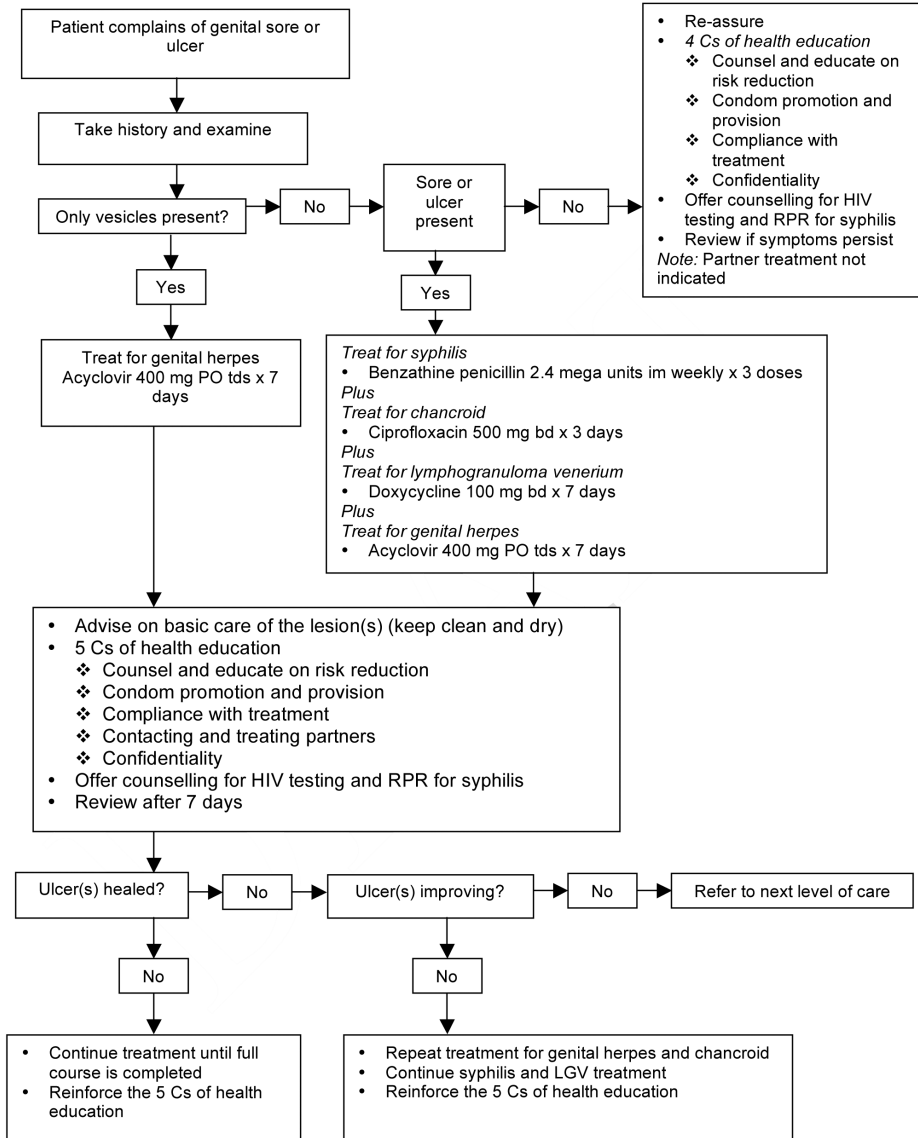


Figure 12.7: Flow chart for genital ulcers

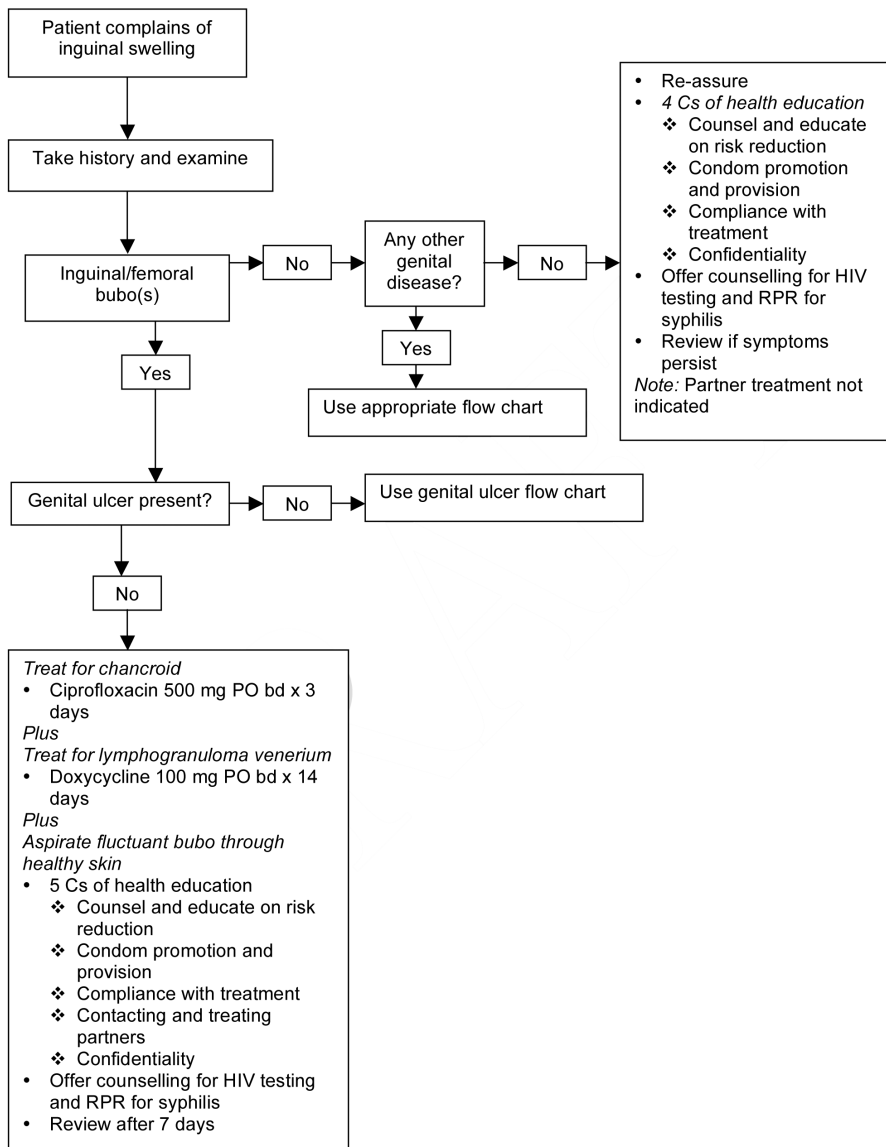


Figure 12.8: Flow chart for inguinal bubo



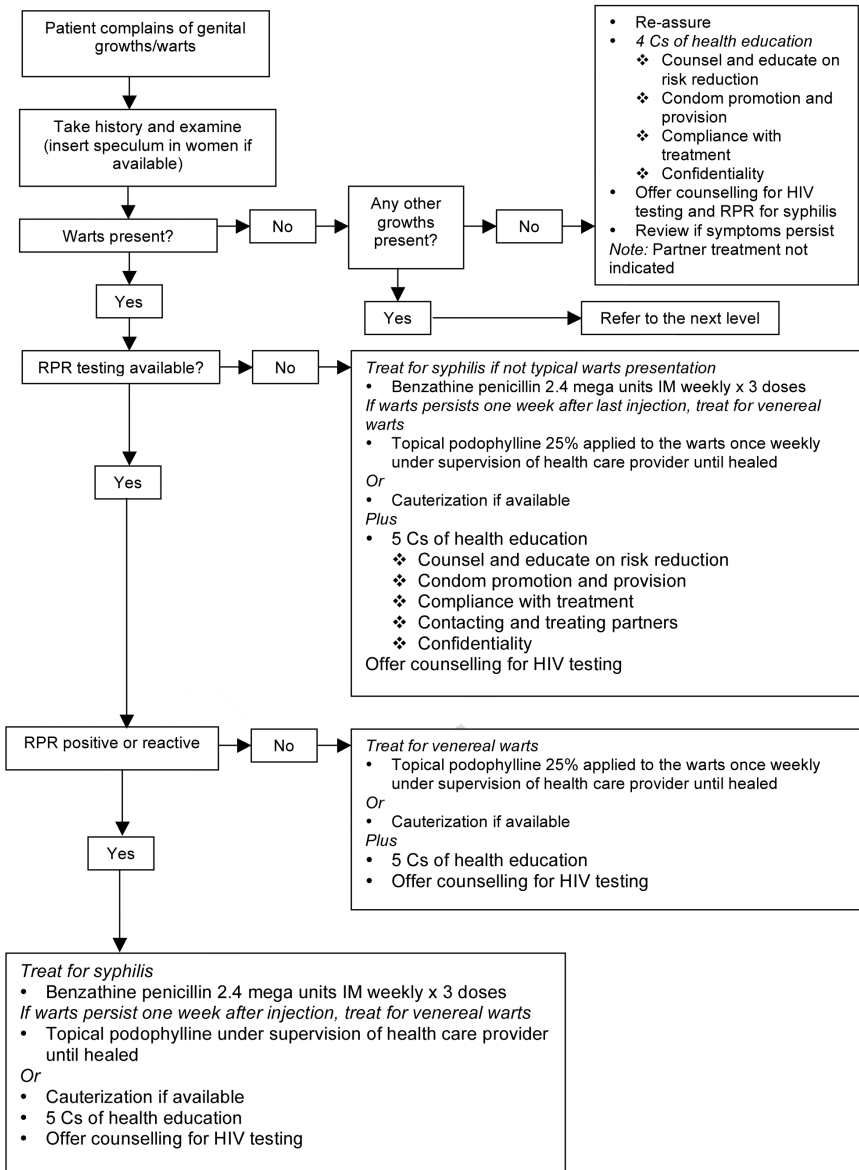


Figure 12.9: Flow chart for genital growths/warts

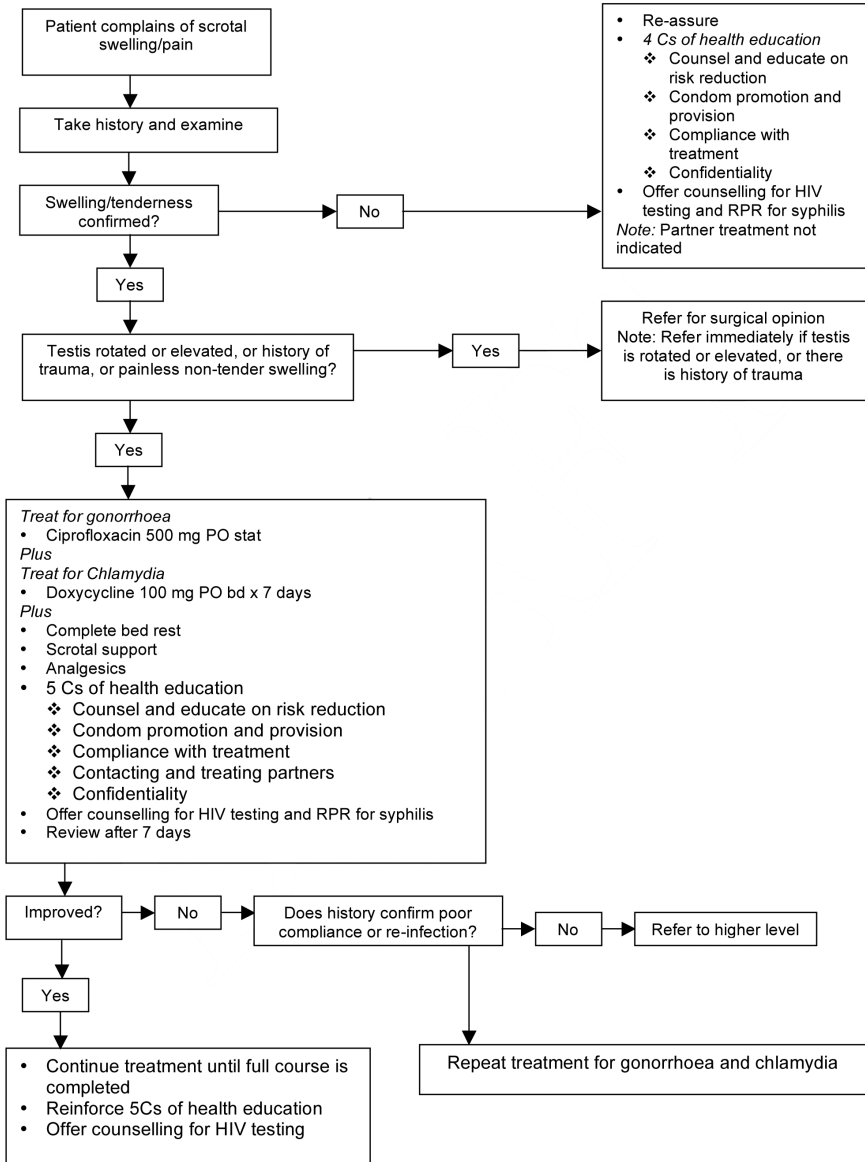


Figure 12.10: Flow chart for scrotal swelling

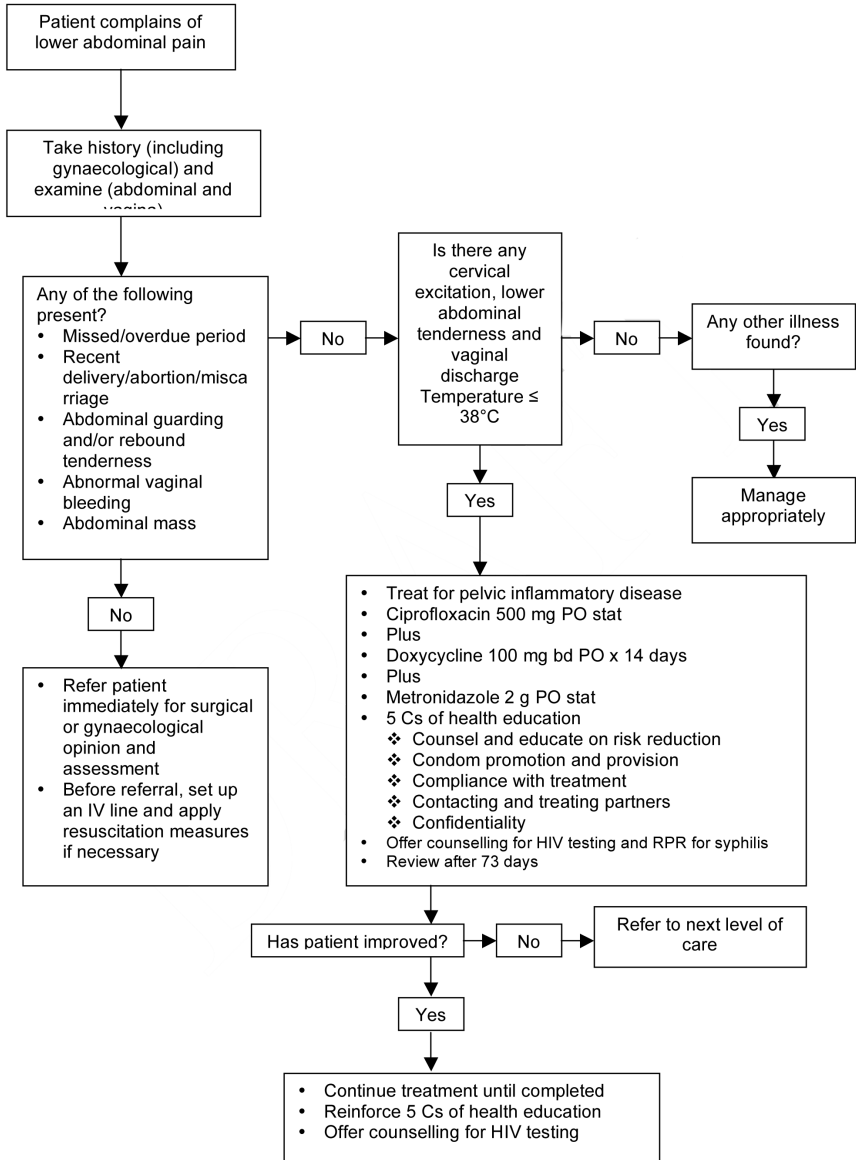


Figure 12.11: Flow chart for female lower abdominal pain

## HIV and AIDS

AIDS is a disease caused by HIV, which gradually and progressively destroys the body's white blood cells (T-lymphocytes). A HIV-infected person may appear healthy and without symptoms, but suddenly develop symptoms of AIDS such as acute progressive weight loss, diarrhoea (which is difficult to control), skin rashes, recurrent fever, and ill health. AIDS currently has no scientifically proven cure, but an HIV-infected person could live a good life if well managed.

## Management of a client suspected to have AIDS

A client may be suspected to have AIDS if he/she presents with any or a combination of the following symptoms:

- Acute progressive weight loss, prolonged cough, or fever
- Prolonged diarrhoea, which may contain blood
- Skin rash with or without itching
- Generalized lymph node enlargement
- Recurrent infections in the mouth and throat
- Excessive tiredness and/or fever

## Assessment of client

Take relevant history from the client to elicit the following:

- Infection with STIs, including genital ulcers
- Casual sex without use of condom
- Multiple sexual partners
- Blood transfusion
- Scarification and tattooing
- Substance abuse, especially intravenous drug use (IDU)
- Previous history of HIV test and/or result
- HIV infection or AIDS in consor

Conduct physical examination and note the following:

- General well-being
- Generalized rash
- Lymph node enlargement

During examination, wear gloves and discard all used syringes and needles safely by burning or burying, or by the system used at the facility.

## HIV/AIDS counselling

Providing HIV/AIDS counselling requires special skills. However, if HIV/AIDS is suspected, its management starts with counselling.

### Types of counselling

#### *Pre-test counselling*

- Establish a good rapport with the client
- Assure the client that testing for HIV is voluntary
- Assess his/her HIV/AIDS knowledge
  - Allow the client to express understating of HIV, then clarify misconceptions and fill knowledge gaps
  - Ask about the client's feelings about testing and previous HIV testing experiences
  - Inquire if client knows anyone with HIV/AIDS, e.g. sexual partner, family member
- Assess risks:
  - Sexual behaviour, without making assumptions about sexual orientation; not all clients are heterosexual
  - Number of sexual partners and partner known risks
  - Frequency of substance in use in the context of sexual behaviour
  - Consistency of condom use
  - Level of assertiveness

- Desire to get pregnant (to prevent mother to child transmission)
- Ability to discuss safer sex practices with sexual partner
- History of sexual abuse or rape
- Assess substance use and other risks:
  - Level of drug and alcohol use including reasons and context in which use occurs
  - Risk of impaired judgment that may lead to unsafe sex
  - Potential need for drug treatment
  - Violence in home and community
  - Substance use in home and community
- Prepare the client for HIV testing (and referral)
  - Inform the client about anonymous and confidential testing
  - Provide education about partner notification programs and other options for disclosure to partners
  - Assess understanding of meaning of a positive and negative test result
  - Assess understanding of benefits of early intervention
  - Discuss strategies for coping (how to relieve stress and anxiety during the testing process)
- Conduct test or refer for testing after obtaining informed consent
- Discuss sexual activities that do not involve exchange of body fluids
- Demonstrate proper male and female condom use on anatomical model and provide opportunity for practice
- Discuss effective ways to communicate role/responsibilities with sexual partner(s)
- If the client is on drugs, discuss harm reduction strategies
- Develop a personalized risk reduction plan
- Discuss postponing sex for clients who are not sexually active

- Determine referral needs (e.g. medical, vocational, rehabilitation from substance abuse, social worker, etc)
- Arrange follow-up appointment and ensure confidentiality in contacting client if needed

### *Post-test counselling*

Receiving HIV test result:

- Ensure that client is ready for results
- Allow client to share his/her initial fears and reaction
- Provide results
- Check client's understanding of results

If client's HIV test is negative:

- Inform him/her that antibodies are detected from three weeks to six months after infection with HIV
- Encourage persons with risky behaviour who test negative to repeat the test after three months
- Remind the client that testing negative does not mean one cannot be infected with HIV in the future
- Encourage him/her to strive to remain negative because engaging in risky behaviour can change the HIV status
- Counsel the client on how to prevent HIV infection transmission:
  - Abstain from sex
  - Be faithful to one partner
  - Use condom each time he/she has sex
  - Desist from sharing sharp instruments, injection, needles, etc
- Encourage the client to ask questions and express concerns
- Encourage follow-up counselling

If the client's HIV test is positive

- Counsel the client that:
  - HIV infected persons can live a reasonably normal life
  - HIV infected persons must seek prompt medical attention when sick
  - HIV infected persons must practice safe sex only
  - pregnancy in the HIV-infected female can affect the unborn baby
  - being aware of the fact that one is HIV-positive gives one the opportunity to prevent others from being infected
- Discuss therapeutic options and build trust; the goal is active participation in all aspects of treatment
- Discuss available treatment options
- Discuss the stages of HIV infection
- Assess the mental state of the client; mental health and cognitive abilities
- Discuss with the client available anti-retroviral regimen and where he/she can get it; acknowledge and address side effects
- Assess physical ability to take medications
- Assess readiness to begin medications
- Educate client about HIV infection: transmission, disease course and benefits of medications
- Discuss follow-up visits:
  - Arrange clinic visits and obtain contact address
  - Facilitate interactions with other clients taking medications
- Provide information on nutrition, because malnutrition is common in HIV infection and reduced food intake, which is associated with anorexia, contributes to poor nutrition. Good food and dietary supplements (vitamin and mineral supplements) improve the quality of life, mental and



physical performance, delay disease progression and improve immunity. Use hygienically safe food and water.

- Give condom if requested
- Explore and acknowledge feelings, fear and identify immediate concerns

## **Mother-to-child transmission of HIV**

Mothers who are HIV infected can transmit the virus to their unborn or newborn babies during pregnancy, delivery, or breastfeeding. Only 30–40% of babies born to HIV-infected mothers become infected, but mother-to-child transmission (MTCT) can be prevented.

### **Prevention (counselling tips) during pregnancy**

- Educate the client on risks involved in transmitting HIV to her baby, including increased risk of spontaneous abortion, stillbirth, prenatal/infant death, pre-term delivery and low birth weight
- Discourage cigarette smoking and hard drug use because these increase foetal exposure to maternal blood through placental disruption, hence increasing the risks of transmission
- Encourage safer sex practices through abstinence or condom use
- Educate client on adequate nutrition and encourage use of haematinics and multivitamin supplements
- Encourage the client to take intermittent malaria prophylactic treatment
- Encourage client to attend a well-equipped health facility and to report to the clinic in case of any complaints
- Inform client on delivery options
- Encourage client to join local support groups within her community

- Advise client on feeding options for the newborn:
  - Use of infant or locally prepared formulae
  - Use of wet nursing (must be an HIV negative woman)
  - Pasteurization of breast milk, i.e. heating of expressed maternal breast milk at 62°C for 30 minutes or bring milk to boil and leave to cool
  - Exclusive breastfeeding for short duration not exceeding 3–6 months
- Advise client to do yearly cervical smear
- If the client decides to breastfeed, she should avoid breastfeeding during maternal and infant illnesses, e.g. when having cracked nipple, mastitis, mouth ulcer, or thrush

### **Precautions during delivery**

- Follow proper infection prevention practices
- Avoid invasive diagnostic procedures, e.g. amniocentesis
- Avoid artificial rupture of membranes
- Episiotomy and instrumental deliveries should be carried out only when indicated

### **Drug therapy**

In accordance with the Nigerian national prevention of mother-to-child transmission (PMTCT) guidelines, ARV recommendations are based on the clinical settings.

*Clinical setting I: Pregnant woman who is eligible for highly active antiretroviral therapy (HAART) but not currently receiving ARV prophylaxis*

- Recommended regimen: ZDV + 3TC + NVP beginning in second trimester if CD4 count is less than 250 for either treatment or prophylaxis

- If CD4 count is more than 250:
  - substitute PI for NVP if available, or
  - substitute EFV for NVP (2nd and 3rd trimesters only)
  - monitor carefully for hepatotoxicity

*Clinical setting II: Pregnant woman not eligible for HAART for her own disease*

- Preferred regimen (in facilities where HAART is available): initiate HAART per clinical setting I after first trimester and continue during labour, but discontinue NVP after delivery
- Alternative regimen (in facilities where HAART is not available): initiate ZDV at 28 weeks gestation or ZDV + 3TC from 34 weeks and continue during labour plus single-dose NVP at onset of labour
- Continue ZDV + 3TC after delivery for seven days

*Clinical setting III: Pregnant woman receiving HAART during current pregnancy*

- Continue with current HAART regimen
- ZDV should be a component of the regimen whenever possible
- EFV is contraindicated in the first trimester and should be replaced with NVP

*Clinical setting VI: HIV-infected woman with active TB*

- Treat the TB first if possible
- Delay HAART until the second trimester if possible
- Rifampin reduces NVP levels (change rifampin to low dose rifabutin)
- Replace NVP with EFV *only if* prophylaxis is delayed until the second trimester
- Avoid ZDV if haemoglobin is less than 8 g/dl

*For ALL women stopping NVP, EFV, or receiving a single dose of NVP intrapartum:*

- Give or continue ZDV + 3TC for seven days postpartum to reduce the risk of NVP resistance

*ARV prophylaxis for the newborn*

All clinical settings:

- Single dose NVP syrup (2 mg/kg) as soon as possible after birth, within 72 hours
- Followed by ZDV syrup (4 mg/kg twice daily) for six weeks, then STOP
- Avoid ZDV if haemoglobin is less than 9 g/dL.

# Infertility

## Description

Infertility is the inability of a couple to achieve pregnancy after having regular unprotected sexual intercourse for one year.

## Objectives

- To obtain and record the history of a client/couple with complaints of inability to achieve pregnancy after one year of unprotected sexual intercourse
- To conduct preliminary counselling for the client/couple
- To provide emotional support for the client/couple
- To refer client/couple to a physician for full fertility assessment and management

## Types of infertility

### Primary infertility

Primary infertility refers to a case where a couple has never achieved a pregnancy.

### Secondary infertility

Secondary infertility refers to a case where a couple has achieved pregnancy before but has failed to achieve another pregnancy.

## Equipment and materials

- Client record
- Referral forms
- Visual aids for counselling, like fertility chart and picture of male/female reproductive tract anatomy
- Instruments for physical examination

## Procedure

- Welcome the client or couple and provide a relaxed atmosphere by:
  - greeting the client
  - offering a seat
  - ensuring privacy and confidentiality
- Explain what you are going to do for the client such as taking a history, conducting physical examination and investigation (where applicable), and referring to a physician
- If a couple comes together, interview them together at first and later separately
- Record the client's history:
  - Personal, medical, obstetrical, gynaecological and social histories (see Chapter 2 on history taking)
  - Ask specifically about previous sexually transmitted infections, tuberculosis, mumps, medications, exposure to toxins (e.g. pesticides, drugs/alcohol, lead), hernia and scrotal operations in the male and douching in the female
- Ask client/couple:
  - if they have been living together continuously for at least one year without using any contraceptives
  - how frequently they have coitus, and timing with ovulation
  - if the man has another wife and if that other wife has a child by him, and the age of the last child
  - if the woman has ever been pregnant by present or any other partner
  - when the last pregnancy or childbirth was
  - if the client/couple has any other concerns, which they wish to discuss

## Important issues for counselling infertile couples

*For emphasis:*

- The need to have sexual intercourse during ovulation and how to calculate the fertile period
- The signs of ovulation, e.g. mid-cycle pain, cervical mucous (see Chapter 4 on fertility awareness-based method)
- Over-exposure of the testes to heat, e.g. use of nylon pants, engine heat during long distance travel
- Other occupational hazards such as exposure to:
  - radiation in radiographers
  - paint chemicals in paint industry workers
  - battery chemicals by “battery chargers” and industrial workers
  - pesticides
- Some behavioural change concerns such as:
  - the need for full cooperation with each other to enable them to cope with stress and societal pressure
  - adequate food intake
  - personal and environmental hygiene
  - avoidance of multiple sexual partners
  - early report of any infection
  - keeping to appointments since treatment may be prolonged
- During the entire process:
  - show empathy; explain any concerns that may have arisen during your conversation with the couple
  - make sure you do not raise false hopes by promising that they will always achieve pregnancy
- Perform a complete physical examination and simple laboratory investigations (haemoglobin estimation, urine testing, etc)

- Record the findings in the client record
- When indicated, request seminal fluid analysis in the male and hystero- salpingogram (HSG) in the female
- Interpret these findings and/or refer with examination findings and investigation report(s) for further fertility assessment and management by a physician

## Assisted reproductive techniques

Assisted reproductive techniques are techniques used to achieve pregnancy by artificial or partially artificial means. The most common application of assisted reproductive technique is to treat infertility but it may also be used to prevent the transmission of genetic diseases. Some of these techniques are:

- Fertility medication (to stimulate ovulation)
- In-vitro fertilization (IVF)
- Artificial insemination (AI)
- Assisted hatching
- Cryopreservation (freezing)
- Sex selection
- Surrogacy
- Reproductive surgery

Most of these techniques are expensive and out of the reach of most couples.



## Adoption

Adoption is another option for infertility management. It is defined as a legal proceeding whereby a court declares a person, who is not a child's natural parent, to be the child's legal parent. Adoption can also be defined as the legal transfer of a child from his/her biological parent(s) to another person or couple who will become the psychosocial parent(s).

If the client/couple is willing to explore this option, counsel them and refer to a social worker who will guide them through the processes involved in adoption.

# Sexual dysfunction

## Description

Sexual dysfunction is a condition that may arise in males and females because of an interaction of many factors such as genetic, social, psychological, physical or medical (hormonal, drugs, substance abuse, etc). It often manifests as lack of sexual satisfaction and is common in chronic alcoholics and those who physically handle chemicals such as pesticides.

## Objectives

- To obtain detailed history from the client
- To identify the presenting symptoms
- To provide supportive care
- To refer the client to a physician

## Types of sexual dysfunction

### Common types in the male

- Erectile failure — the failure to have penile erection, such as impotence
- Premature ejaculation — undesired uncontrollable ejaculation before penetration
- Orgasmic failure — inability to reach orgasm during sexual intercourse
- Lack of libido or sexual desire

### Common types in the female

- Vaginismus — spasm of the vagina, which restricts penile entry
- Dyspareunia — pain during sexual intercourse, which may be superficial or deep

- Orgasmic failure — inability to achieve orgasm during sexual intercourse
- Lack of libido or sexual pleasure

## Equipment and materials

- Client record form
- Referral forms
- Visual aid for counselling (reproductive tract anatomy)
- Educational leaflets or brochures

## Procedure

Make the client comfortable, show empathy, and reassure.

### History taking

Take note of the following complaints:

#### *In men*

- Absence of sexual desire
- Very quick ejaculation, faster than usual experience
- Failure to achieve or maintain penile erection despite sexual urge
- Painful sexual intercourse
- Sexual orientation
- Family/marital status
- History of drug/alcohol use
- Failure of ejaculation

#### *In women*

- Painful sexual intercourse
- Difficulty in penile penetration during sexual intercourse
- Vaginal bleeding during or after coitus
- Lack of interest in sexual activities
- Feeling abnormal within oneself
- History of any traumatic experiences (e.g. rape or abuse)

- Sexual orientation
- Family/marital status
- History of drug abuse

### **Physical examination**

Conduct physical examination, paying attention to the following:

- General appearance — mood, physique, consciousness
- Genitalia, noting signs of previous female genital cutting
- If bruised, clean and treat appropriately (e.g. give antibiotics, KY jelly and analgesics)

### **Counselling**

- Explain stages of the human physiological response to sexual arousal and intercourse
- Explain different sexual positions, use of fantasy, foreplay techniques, change of environment and timing of sex
- Attend to concerns of the clients, e.g.
  - experiences with partner
  - inability to respond to partner's advances due to physical or mental apathy/exhaustion
- Explore the psychological basis for complaints in line with past experiences, such as:
  - fear of punishment for disapproved behaviour
  - submission to a man
  - fear of pregnancy
  - hostility towards men and conflicting values on sexual attachments
- Give date for follow-up visit
- Refer when necessary

# Cancers of the reproductive organs

## Description

Cancer of the reproductive organ is an abnormal/malignant growth of the reproductive organ, which commonly affects the cervix, uterus, ovaries and breasts in women, and the prostate glands in men. Tumours of the genital tract may be benign or malignant. Examples of benign tumours are uterine fibroids, simple ovarian cysts, fibro-adenomas and benign prostatic hypertrophy.

## Objectives

- To record detailed history of the client
- To perform physical examination to detect signs of genital cancer
- To provide preliminary counsel to the client
- To provide emotional support to the client
- To refer client to the physician for appropriate diagnosis and management

## Types of malignant tumours of the reproductive organs

### Common reproductive organ cancers in women

- Cancer of the breast
- Cancer of the cervix
- Cancer of the uterus
- Cancer of the ovaries
- There may be cancer of the vulva, vagina, and fallopian tubes, but they are rare

## **Most common cancer of the reproductive organ in men**

- Cancer of the prostate
- Cancer of the of the testes (however, this is rare)

## **Equipment and materials**

- Client record form
- Referral form
- Visual aids for counselling (reproductive organ chart)
- Instruments for physical examination

## **Procedure**

- Greet and welcome client warmly
- Offer him/her a seat
- Provide privacy
- Explain what you are going to do, such as history taking, physical examination, some laboratory investigations (where applicable) and referral to a physician

## **History taking**

Ask for the following:

- Personal history
- Medical history
- Obstetrical and gynaecological history
- Social history
- Note information on:
  - report of pain
  - bleeding and any lump
  - any drug therapy, e.g. any treatment with hormones

## **Physical examination**

Take note of the following:

- Vital signs (TPR, weight and blood pressure)
- Lump in the breast

- Mass in the uterus (on abdominal palpation)
- Bleeding
- Discharge
- Take sample for pap smear and cervical cultures if possible
- Where this is not possible, note on referral form
- Prostate mass

## Management

- Counsel and give emotional support to the client, spouse and other family members
- Educate client and family on predisposing factors to reproductive cancers
- Record all relevant information and maintain confidentially
- Provide palliative treatment and refer to a physician

For clients, who do not have cancer:

- Explain the technique of breast self examination
- Encourage the client to regularly examine her breast
- Emphasize the need for routine cervical cytology screening

### *Techniques of breast self examination*

- Examine the breast immediately after menstruation and daily, subsequently
- Stand in front of a mirror and observe the shape and size of each breast; note any abnormal swellings, distortion or skin change
- Lie flat on your back
- Use the palm and not the fingers to palpate each segment of the breast in a circular motion (use right palm for the left breast and the left palm for the right breast)
- Note the presence of any fixed or movable lump
- Report the presence of a lump to a doctor or health worker immediately

### *Cervical cytology*

Cervical cytology should be conducted on all clients every two years or more often (yearly) in clients with:

- multiple sexual partners
- history of STI
- high parity
- family history of genital tract cancer
- previous abnormal cervical cytology

### *Techniques for taking a pap smear (cervical cytology)*

- Label the glass slide properly
- Insert the Cusco's speculum (using only water as lubricant) into the vagina to expose the cervix
- Look for evidence of infection and if there is any:
  - collect specimen and send for microscopy/culture/sensitivity
  - treat infection
  - postpone pap smear till infection has cleared
- If there is no infection:
  - use the wooden spatula (Ayre's spatula) to take cells from the squamo-columnar junction by applying a firm scrapping movement, passing the spatula completely round the cervical os
  - smear cells on the labelled glass slide
  - put the slide immediately in 95% alcohol and send it for examination

*Note:* Where cytology services are not available, acetic acid test should be conducted on the cervix.

### *Technique for acetic acid test*

- Insert the Cusco's speculum (using only water as lubricant) into the vagina to expose the cervix
- Look for evidence of infection and if there is infection:



- collect specimen and send for microscopy/culture/sensitivity
- treat infection
- postpone the test till infection is cleared
- If there is no infection:
  - apply 3–5% acetic acid with a cotton swab/bud to the entire cervix and wait for 30 seconds
  - examine the cervical epithelium
  - abnormal areas with high protein but low glycogen content will appear whitish
  - normal areas with adequate glycogen content will remain pinkish to light gray
  - counsel client appropriately
  - refer clients with whitish reaction to the physician for further evaluation

*Note:* Whitish reaction to acetic acid does not confirm cancer, because the cells may just be abnormal (pre-cancerous) but not cancerous.

## Prevention

Ask the client to educate friends, relatives, and public on:

- personal hygiene
- modification of high risk behaviour such as unsafe sexual practices, multiple sexual partners and smoking
- avoidance of early sexual intercourse (not earlier than 18 years)
- harmful traditional practices such as early marriage and female genital mutilation
- importance of prevention of STI/HIV/AIDS
- periodic cervical cancer screening
- use of HPV vaccine

# Menopause and andropause

## Description

*Menopause* is the cessation of menstruation, which occurs naturally between ages 45 and 55 years. It occurs gradually with irregular menstrual flow, which can be scanty or excessive before it stops completely. *Andropause* refers to the changes that start to occur in men between ages 55 and 60 years and is associated with reduced functions of the testes.

## Objectives

- To recognize the signs and symptoms of menopause and andropause
- To help the client in coping with changes associated with menopause and andropause
- To provide supportive care where applicable
- To refer appropriately

## Changes that occur in menopause and andropause

### Menopause

- Irregular, reduction, or cessation of menstruation
- Hot flushes
- Reduced sexual libido
- Scanty pubic hair
- Diminished vaginal secretion
- Weakness of the muscles of the vaginal wall
- Poor tone of the pelvic floor

## **Andropause**

- Decreased sexual libido
- Poor erection
- Testes become smaller and loose firmness

## **Equipment and materials**

- Client record form
- Referral forms
- Visual aids for counselling (menstrual cycle and sperm formation chart)
- Instruments for physical examination (thermometers, sphygmomanometer, speculum)

## **History taking and physical examination**

- Welcome the client and provide a relaxed atmosphere by:
  - greeting the client
  - offering a seat
  - ensuring privacy and confidentiality
- Obtain detailed history of presenting condition and observe obvious signs whilst taking history and conducting physical examination

## **Signs and symptoms**

### **Menopause**

- Internal heat associated with sweating (hot flushes)
- Prickly sensation
- Tiredness
- Painful or stiff joints
- Loss of libido
- Painful sexual intercourse
- Palpitations
- Reduced concentration
- Insomnia

- Nervousness/irritability
- Depression
- Loss of skin texture
- Dry skin (leathery)
- Scanty hair in the genital area

### **Andropause**

- Loss of hair apart from familial baldness
- Frequent headaches and backaches
- Joint and muscle pains
- Sexuality, which is independent of the partner, for example, masturbation
- Frequent failure of penile erection
- Increased blood pressure
- Increased fatigability
- Gradual loss of libido
- General weight gain due to lack of exercise in some people

### **Physical examination in women**

- Conduct general examination to check for:
  - evidence of emotional disturbance
  - pallor
  - breast abnormalities such as discharge, lump
  - abdominal masses
- Perform a gentle pelvic examination (digital and speculum) and note the following:
  - Any discharge/bleeding
  - Presence of genital prolapse
  - State of the cervix
  - Take cervical smear
  - Size and shape of the uterus

## **Physical examination in men**

- Check for
  - evidence of emotional disturbance
  - pallor
  - abdomen for masses
  - abnormality of the prostate

## **Laboratory investigation**

### *In women*

- Cervical cytology

### *In men*

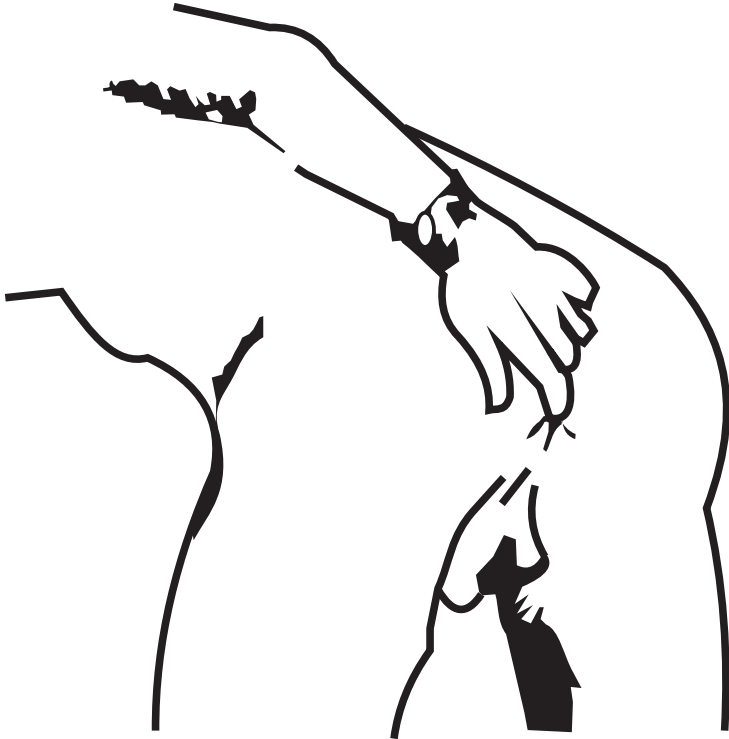
- Prostate specific antigen (PSA)
- Record all relevant information in the client record form
- Interpret the key findings and offer first line treatment to alleviate the associated symptoms. These may include:
  - use of tranquilizers, e.g. Bromazepam, Diazepam
  - supplementation with micronutrients and vitamins, e.g. calcium, vitamin B complex
  - application of lubricants for dryness at the vagina, e.g. KY jelly
  - educating client on the need for a return visit if symptoms persist
- Counsel and explain reasons for the body changes and ways of coping with the changes (see Chapter 1 for counselling tips)
- Counsel on osteoporosis, heart diseases, diabetes, dietary intake, relationship with partner(s), and contraceptive use during this phase
- Teach client self breast or self prostate examination
- Refer for further care where necessary

## **Self-examination of the prostate**

Self-examination of the prostate is usually done through the rectum.

### Steps

- Put a rubber glove on one hand to protect your hand, as the rectum may contain faeces during this period
- Lubricate your index finger (which is next to the thumb) to allow easy access to the rectum; use Vaseline or KY jelly
- Put the index finger inside the rectum as far as you can go (Figure 16.1)
- Try and feel for the prostate through the wall of the rectum



*Figure 16.1: Self-examination of the prostate*

*Note:* When you press the prostate, you will have a feeling of wanting to pass urine (urinate). You may also feel some pain at the tip of the penis. Remember that the normal prostate should feel firm and smooth with slight V-shaped groove. But if hardness or lump is felt, accompanied with pain, it is an indication that something is wrong.

*If abnormal condition is noticed or detected:*

- keep calm; do not panic or feel embarrassed
- see your doctor immediately for examination and further check-up to confirm or correct your findings. The doctor will advise you.
- do not delay in consulting a specialist doctor because the situation may get worse and become too late to treat.

# Management information system

## Description

Management information system (MIS) is an organized way of recording, collating, and interpreting information for planning and decision-making.

## Objectives

- To complete required forms accurately
- To compile collected data
- To analyze data
- To interpret analyzed data
- To facilitate decision-making for planning, implementation and evaluation

## Types of information in MIS

- Client records
- Logistics records
- Methods of contraception
- Personnel
- Equipment

## Types of forms

### Community level

- CBD voucher

### Health facility level

- Daily clinic register
- Daily consumption record (DCR)
- Requisition, issue and report form (RIRF)



- Cost recovery record (CRR)
- NHIMS monthly forms

### **LGA level**

- Tally cards
- Requisition, issue and report form
- Cost recovery record
- NHMIS forms

### **State level**

- Tally cards
- Requisition, issue and report form
- Cost recovery record
- NHMIS forms

## **The role of the health provider in MIS**

### **General**

- Ensures that service data are collected and collated regularly
- Forwards information to appropriate quarters in time
- Ensures that the record is checked daily, monthly, quarterly, semi-annually and annually

### **Daily**

- Ensures availability of MIS report forms
- Completes (fill out) client record form and daily activity register
- Stores client forms properly on shelves or in the cupboard
- Ensures that all records are completed at the end of each day

## **Monthly**

- Ensures collection of record from necessary sources, e.g. from voluntary health workers (VHWs), traditional birth attendants (TBAs), community health extension workers (CHEWs), primary health centres (PHCs), etc
- Summarizes the daily activity registers and transfers appropriately to the daily consumption record
- Completes the daily consumption record
- Forwards collated forms to appropriate LGA RH/FP coordinator
- Analyses information and makes graphic presentation of data collected
- Displays data charts in the staff room for all to refer to or make use of
- Interprets data and uses same for management decisions

## **Bi-monthly: provider at health facility**

- Completes requisition issue and report form
- Forwards to RH/FP local government supervisor

## **Quarterly at the LGA level: LGA FP supervisor**

- Completes the RIRF forms
- Forwards to state FP coordinator
- Updates the tally cards
- Completes the cost recovery record
- Completes the NHMIS forms

## **Every four months at the state level: State FP Coordinator**

- Completes the RIRF
- Forwards to central level
- Updates tally cards
- Completes the cost recovery record
- Summarizes the NHMIS forms

### **Semi-annually**

- Collates two quarterly summary reports, e.g. January to March and April to June into one semi-annual form to cover the period January to June for the year
- Forwards appropriately from the state to the zone
- Analyses and interprets data for management decisions

### **Annually**

- Collates all monthly, quarterly or semi-annual summary forms
- Summarizes into annual form
- Forwards it to the appropriate office
- Analyzes data collected, i.e. the Department of Health Planning and Research and the Department of Community Development and Population Activities
- Makes graphic presentation and display to show program performance
- Interprets data for management decisions.

# Clinic management

## Description

Clinic management involves organizing and coordinating providers' activities to establish and sustain quality family planning services.

## Objectives

- To ensure that appropriate resources (equipment, personnel, finance) for the establishment of a family planning clinic are identified and provided
- To set up a family planning clinic with accessible services that are acceptable to the client
- To ensure uninterrupted supply of contraceptives, commodities/supplies
- To supervise and monitor family planning services in the clinic
- To ensure appropriate storage for commodities and supplies

## Clinic requirements

Minimum requirements for a family planning clinic include:

- Space for reception, consulting, counselling, examination, procedures, and storage (2 rooms)
- A theatre and a recovery room for voluntary surgical contraception
- Toilet facility

## **Furniture/equipment/materials**

- Examination table/couch (1)
- Desks (2)
- Chairs for staff and clients (4)
- Benches for clients (2)
- Stool for the examiner (1)
- Sink with running water or a bowl in a stand (1)
- Filing cabinet for record and files (1)
- Cupboard for storing contraceptives (1)
- Desk and chair for receptionist (optional) (1)
- Table for sterilizer (1)
- Cabinet to store equipment and supplies (1)
- Chalkboard for IEC illustration (1)
- Flip chart stand, blackboard, painted sidewall (1)
- Assorted IEC materials
- Cotton wool/gauze (12 rolls)
- Sanitary pads (24 packets)
- Disposable gloves (size 7) (200 pairs)
- Latex rubber gloves (sizes 6, 7 and 8) (72 pairs)
- Stove, lantern, kerosene and matches (as needed)
- Disinfectant (sodium hypochlorite, e.g. household bleach) (50 litres)
- Antiseptic lotion (such as *Savlon*) (5 litres)
- Soap for washing hands (24 bars)
- Acetic acid (2 litres)
- Wooden spatula (200 pieces)

*Note:* Replenish as required

## **Linen**

- Mackintosh (10)
- Draw sheets (6)
- Dirty linen bag (2)
- Hand towels (6)
- Sterile linen and drapes for implants and VSC (16)

## Instruments

- IUD kits (6)
- Contents of the IUCD insertion kit vary, depending on the source of supply. However, it should contain the following:
  - 3 vaginal specula (1 large, 1 medium, 1 small)
  - 1 Vulsellum or Tenaculum
  - 1 gallipot
  - 1 pair of blunt-nosed scissors
  - 1 pair of latex rubber gloves
  - Uterine sound
  - 2 sponge holding forceps
  - Insertor
  - IUD
- IUD remover hook (2)
- Implant insertion/removal kit (6)
  - Sterile/clean dry surgical drape
  - Pair of sterile latex gloves
  - Syringe (5 or 10 ml) and 2.5 to 4 cm long needle (22G)
  - Size No. 10 trocar with plunger
  - Scalpel with size No. 11 blade
  - Ordinary band aid or sterile gauze with surgical tape
- Instrument trolleys (2)
- Cheatle forceps (1)
- Forceps holding jug (1)
- Sims specula (1 large, 1 medium) (2)
- Blunt nose scissors (2)
- Alligator forceps (2)
- Remover hook (2)
- Large kidney dish (1)
- 20 cm by 12.5 cm rectangular covered tray for sterilizing solution for Lippes loop (2)
- Graduated plastic uterine sound (2)

- Plastic buckets with lids (1 for dirty cotton wool and used disposable gloves, 1 for contaminated linen and 3 for cleaning) (5)
- MVA kit (where necessary) (2)
- Fitting rings (for diaphragm) (1 set)
- Stethoscope (2)
- Blood pressure apparatus (sphygmomanometer) (1 small and 1 large cuff) (2)
- Torch with battery or angle-poised lamp (2)
- Adult scale (1)
- Brushes (for hand, instrument and general scrubbing) (10)
- Autoclave (1)
- Autoclave drum (1)
- Screen (1)
- Utility gloves (12)
- Clinical thermometer (oral) (2)
- Pedal bin (1)
- Brooms (20)
- Mopping bucket and mop stick (6)
- Flannels for dusting (12)
- Electric sterilizer (1) **OR**
- Stove and ten-litre size covered aluminum pot (2)

### **Stationery**

- FMOH-approved client record cards (200)
- FMOH-approved management information system forms for:
  - Monthly report (200)
  - Daily activity (200)
  - Commodity supply (200)
  - Commodity request (200)
  - Referral forms (200)
- Book-keeping ledgers for revenue generated (2)

- Informed consent form for voluntary surgical contraception (100)
- Client register (2)

### **Audio-visual aids**

- Samples of contraceptives (10)
- Models, i.e. pelvis, wooden/plastic penis, breast (Eve's model)
- Flip chart for male and female reproductive anatomy (10)
- Pamphlets or method booklets (200)
- Posters

### **Commodities**

- Oral contraception pills (low dose) (200 cycles)
- Male condom (600 pieces)
- Female condom (50 pieces)
- IUD (50 units)
- Injectables (50 vials)
- Cycle beads (50 pieces)
- Implants (50 pieces)
- Spermicides (500 pieces)
- Diaphragm (2 sets of all) (2 set sizes 60–85)
- Circle beads (5 pieces)

## **Setting up a clinic**

Set up the clinic space to allow for:

- easy access to instruments during examination and insertion of IUD
- privacy of clients in counselling room
- display of family planning messages and wall charts in counselling room and reception area



## Client flow

- Establish follow-up system as determined by specific contraceptive methods
- Clients with complication should be given priority
- Display a poster showing client movement in the clinic to enhance smooth client flow
- Conduct client flow analysis quarterly as follows:
  - Work with staff members to develop a work sheet for client flow analysis
  - Develop a client flow analysis work sheet to measure FP clients waiting time and contact time with staff
  - Specify the type of services being provided, e.g. “full” for new clients and “partial” for old clients
  - Analyze information gathered on the client analysis work sheet to identify bottlenecks in your clinic service time
  - Find the percentage of the total waiting time spent in contact with staff to determine effective staff utilization
  - Utilize your results to improve or modify the client flow chart as needed

## Clinic hours

Use the following guidelines to establish clinic hours and schedule outreach services:

- Assess the needs of the community
- Establish clinic hours and an outreach services schedule
- Develop a schedule for community health workers to conduct home and community visits
- Make clinic hours flexible to enable the community to utilize family planning services

## Staffing and staff management

### Staff requirements

- Staff requirements depend on the expected workload. Ideal minimum staff recommended for a family planning clinic is:
  - 2 family planning providers
  - 1 motivator/community health worker
  - 1 ward maid/receptionist

### Staff management

- Develop job descriptions for all staff positions
- Assign routine tasks
- Educate the ward maids to wash and sterilize equipment in the clinic and maintain cleanliness
- Maintain good rapport between clients and staff and amongst staff
- Conduct monthly staff meeting
- Request more staff as clinic services grow

## Record keeping

Federal Ministry of Health has approved the utilization of a set of management information forms, which are available throughout the nation. If clinic staff are not familiar with these forms, it will be necessary to contact the state family planning coordinator for assistance. A copy of such requests should be forwarded to the Family Health Department, Federal Ministry of Health (FMOH), Abuja. Complete and submit forms according to the procedure in NHMIS.

## Supervision, monitoring and evaluation

- Conduct client flow analysis quarterly
- Ensure efficient time management and client satisfaction

- Conduct service evaluation
- Monitor outreach activities

*Note:* Use appropriate FMOH supervisory checklist.

## Defaulter tracing

Follow the procedure for tracing defaulters as described in FMOH integrated NHMIS manual for family planning.

## Commodity supply, re-supply and storage

### Supply and re-supply

- Set aside space for storage of contraceptive commodities
- Determine the amount of contraceptives as in CLMS handbook
- Maintain this level to ensure uninterrupted supply of contraceptives
- Use commodity supply forms approved FMOH to make your returns and request as needed

### Commodity storage

- Ensure that there is adequate air circulation
- Keep cartons at least 0.3 meter away from the wall
- Ensure that commodities are placed on platforms at least 10 cm above the floor
- Establish first expiry first out (FEFO) system to ensure that no commodity expires while still in the store
- Establish an inventory procedure to enable you to determine your stock level and your needs at all times (using the CLMS inventory card)
- Label all shelves in the store
- Clean the store periodically to eliminate rodents, white ants and cockroaches
- Use the guide in the CLMS handbook to estimate your contraceptive needs

## Equipment maintenance

### Stethoscope

- Use a damp cloth to wipe the metal parts of the stethoscope periodically and shine with a dry cloth
- Check the rubber parts for deterioration
- Do not store stethoscopes in hot and humid places
- Clean the earpieces with 70% alcohol daily

### Blood pressure apparatus

- Store in a cool place
- To wash the cuff, remove the rubber component
- You may introduce a small amount of powder to the pump (bulb)
- Avoid over-inflation of the cuff when using

### Metal instruments

- Wash and sterilize them (see Chapter 19 under infection prevention)
- Do not soak for too long in water to prevent rust

## General

- Set aside a regular time for cleaning the facility (see Chapter 19)  
Do this when the clinic is not busy

# Infection prevention in family planning services

## Description

Infection prevention in family planning services is a practice that helps reduce the risk of transmitting infections in healthcare facilities.

## Objectives

- To ensure that procedures in family planning are done without risk of infection to client, provider, and the community
- To ensure the use of practical and visible low technology approaches for reducing the risk of infection
- To ensure a clean and safe clinic environment

## Aseptic techniques

Aseptic techniques are routine practices before, during and after clinical procedures.

### Hand washing

Hand washing may be the single most important procedure for preventing infection. It is indicated:

- when examining a client (before and after each client)
- when putting on sterile gloves for surgical procedure
- after any situation that may make hands to be contaminated
- after removing gloves

### *Types of hand washing*

- Plain soap with running water – routine
- Antiseptic with running water
- Alcohol scrubs

### *Steps*

- Wet the hands with running water
- Rub both hands together with soap and lather, making sure to rub all parts of your hands
- Vigorously weave fingers and thumbs together and slide them back and forth for 10–15 seconds or for longer if hands are visibly soiled
- Remember to wash around the nails
- Rinse hands under a stream of clean, running water until all soap is gone
- Dry hands with a clean towel or allow hands to air-dry

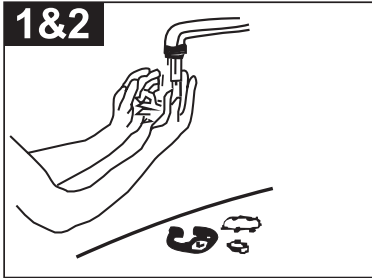
*Note:* Hands should be washed first on arrival at work, in-between attending to clients, and as the last thing when leaving the health facility.

### **Surgical hand scrub**

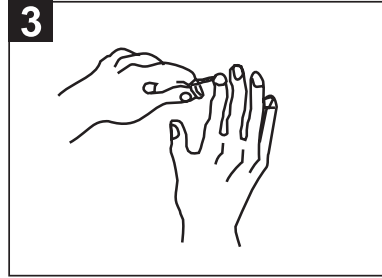
- Remove all jewellery
- Wet hands and forearms thoroughly
- Clean fingernails with a brush
- Hold your hands up above the level of your elbows
- Apply antiseptic
- Using a circular motion, begin at the finger tips of one hand, lather and wash between fingers, continuing from finger tips to elbows
- Repeat for the second hand and arm for 3–5 minutes
- Rinse each arm separately, finger tips first, holding your hand above the level of your elbow

- Using a sterile towel, wipe your arms dry from finger tips to elbow
- Use one side of the towel to dry the first hand and the other side to dry the second hand
- Keep your hands above the level of your elbows and do not touch anything

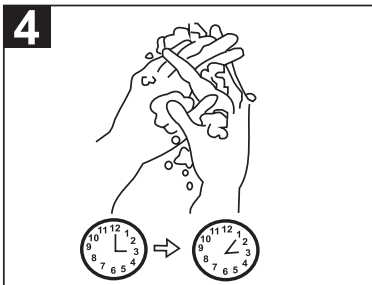
*Note:* Recent studies have shown that using a brush to scrub the hand during surgical hand scrub provides no greater reduction in the number of microorganisms on the hands than scrubbing with antiseptic alone. Surgical hand scrub may be performed using either a soft brush, a sponge or antiseptic alone. Avoid using a hard brush, which is not necessary and may irritate the skin.



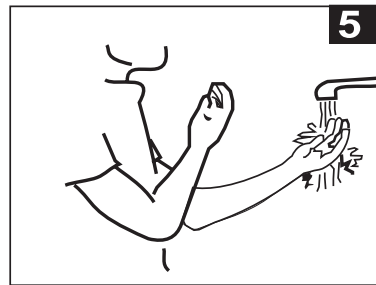
Remove all jewelry on your hands and wrists. Adjust the water to a warm temperature and wet your hands and forearms thoroughly



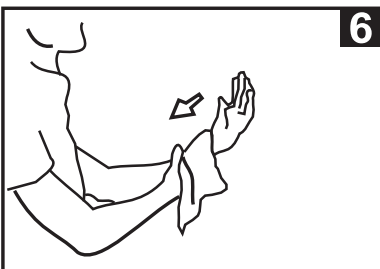
Clean under each finger nali with a stick or brush (*Note fingernails should be kept short*)



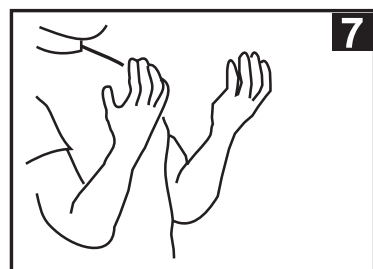
Holding your hands up and above the level of your elbow, apply the antiseptic. Using a circular motion, begin at the finger tips of one hand and lather and wash between the fingers, continuing from finger tip to elbow. Repeat this for the second hand and arm. Continue washing for 3-5 minutes



Rinse each arm separately, finger tips first, holding your hand at the level of your elbow



Using a sterile towel, wipe your arm, from finger tips to elbow, dry. Use one side of the towel to dry the first hand and the other side of the towel to dry the second hand

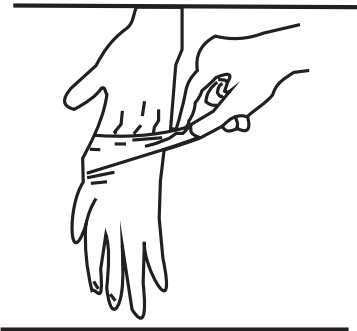


Keep your hands above the level of your elbow and do not touch anything

*Figure 19.1: Steps in performing a surgical hand scrub*

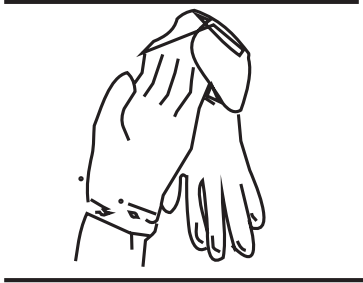


## Steps for putting on sterile or high-level disinfected surgical gloves



1. Prepare a large, clean, dry area for opening the package of gloves. (If the gloves have been processed and are not wrapped in a package, lay them on a sterile or high-level disinfected surface). Either (1) open the outer glove package and then perform a surgical hand scrub, or (2) perform a surgical hand scrub and then ask someone to open the package for you. Dry your hands completely.
2. Open the inner glove wrapper, exposing the cuffed gloves with the palms up.
3. Pick up the glove by the cuff, touching only the inside portion of the cuff (the side that will be touching your skin when the glove is on).
4. While holding the cuff, slip your other hand into the glove. (Pointing the fingers of the glove toward the floor will keep the fingers open). Be careful not to touch anything, and hold the gloves above waist level. (Note: if the first glove is not fitted correctly,

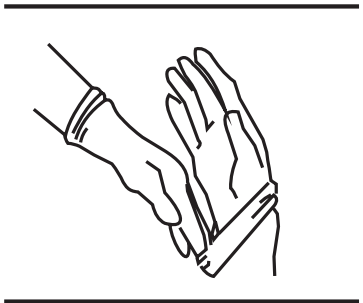
wait to make any adjustment until the second glove is on. Then use the sterile or high-level disinfected fingers of one glove to adjust the sterile or high-level disinfected portion of the other glove).



5. Pick up the second glove by sliding the fingers of the gloved hand under the cuff of the second glove. Be careful not to contaminate the gloved hand with the ungloved hand as the second glove is being put on.

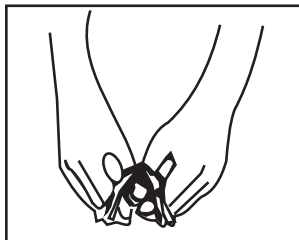
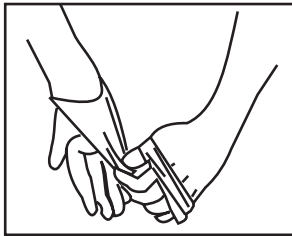
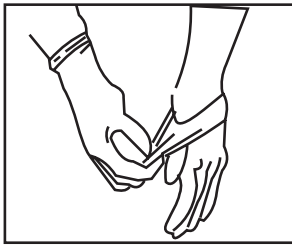
6. Put the second glove on the ungloved hand by maintaining a steady pull through the cuff.

7. Adjust the position of the gloved fingers until the gloves fit comfortably.



Adapted from: Intrah, 1996. Infection Prevention in FP/MCH Clinics. In: Guidelines for Clinical Procedures in Family Planning: A Reference for Trainers. Chapel Hill, NC, pp. A11-22, A11-23.

## Steps for removing surgical gloves



1. Rinse gloved hands in a basin of decontaminated solution to remove blood or other body fluids.
2. Grasp one of the gloves near the cuff and pull it part of the way off. Turn the glove partially on your hand before removing the second glove to protect you from touching the outside surface of either glove with your bare hands.
3. Leaving the first glove over your fingers, grasp the second glove near the cuff and pull it part of the way off. The glove will run inside out. It is important to keep the second glove partially on your hand to protect you from touching the outside surface of the first glove with your bare hand.
4. Pull off the two gloves at the same time, being careful to touch only the inside surfaces of the gloves with your bare hands.
5. If the gloves are disposable or are not intact, dispose of them properly (as stated under information on managing medical waste at the end of this chapter). Wash your hands immediately after removing the gloves, since the gloves may contain invisible holes or tears, leaving you at risk of exposure to contaminated blood and other body fluids.

## **Surgical attire**

- This includes wearing of masks, eye covers, caps, footwear, gowns and gloves

## **Preparing clients for clinical procedures shaving**

- This is no longer recommended, but if you must shave, use antimicrobial soap and water or shave dry. In each case, shave just before surgery
- Prepare the skin using antiseptic, e.g. Iodophor (Betadine), 4% Chlorhexidine (eg *Hibitane*), 1–3% Iodine, followed by 60–90% alcohol
- Wipe off excess antiseptic with sterile dry cotton gauze
- Clean vagina with antiseptic such as Chlorhexidine with Cetrimide, e.g. *Savlon*
- Clean cervix with Iodophor, e.g. *Betadine*

## **Steps for maintaining a sterile field**

- Place only sterile items within the sterile field
- Open, dispense, and transfer sterile items without contaminating them
- Consider items located below the level of draped painted as unsterile
- Do not allow *scrubbed personnel* to reach across unsterile areas or touch unsterile items
- Do not allow *unscrubbed personnel* to reach across sterile field or touch sterile items
- Recognize and maintain sterile field
- Recognize that the edges of a package containing sterile items are unsterile
- *Recognize that a sterile barrier that has been penetrated is considered contaminated*
- Be conscious of where you are at all times and move within or around the sterile field
- Do not place sterile items near open windows or doors

### **Steps for using good surgical technique**

- Ensure gentle handling/minimal manipulation of tissues during surgery
- Control excessive blood loss

### **Steps for maintaining a safer environment**

- Limit entry of unauthorized individuals to surgical/procedure areas
- Close doors and draw curtains during all procedures
- Ensure that all personnel in the surgical area wear clean clothes, masks, caps and good footwear
- Enclose the surgical procedure area; to minimize dust and eliminate insects, air-condition the room
- Decontaminate and clean examination/operating tables, counters, instrument trolleys, etc, before a new client is brought into the room

## **Processing used instruments and other items**

### **Decontamination**

Decontamination makes instruments and other items, including surfaces, safe for cleaning.

#### *Steps*

- Prepare chlorine solution by mixing bleach e.g. *Jik* (one part bleach to six parts clean water)
- Soak used instruments/items in 0.5% chlorine solution for 10 minutes

### **Cleaning**

Cleaning is a crucial step in making instruments and other items safe and infection free.

### *Steps*

- Use detergent, water and brush/sponge to remove blood, other body fluids, organic materials, tissues, and dirt from instruments and other items
- Rinse instruments and other items with clean water
- Machine-dry or dry linen and clothing in the sun
- Limit handling to avoid re-contamination

### **High-level disinfection**

High-level disinfection (HLD) is a process that eliminates all microorganisms (bacteria, viruses, and parasites) but does not reliably kill all bacterial endospores. It can be done by boiling or by the use of chemicals.

#### *Steps for boiling*

- Decontaminate
- Clean
- Open all instruments
- Submerge completely
- Cover the pot
- Bring water to a rolling boil
- Start timing for 20 minutes. *Do not add or remove instruments/other items from the boiling water.*
- Remove instruments and other items using dry HLD cheater forceps or lifters
- Place instruments in HLD or container
- Allow to air-dry before use or storage

#### *Steps for using of chemicals*

- Decontaminate
- Clean dry instruments thoroughly
- Prepare sodium hypochlorite solution in a clean container with a lid
- Open all hinged instruments/items

- Completely submerge instruments in the solution for 20 minutes
- Do not add or remove any instrument before this time
- Remove instruments from the solution using HLD lifters or cheater forceps
- Rinse thoroughly with boiled water to remove residue from instruments and other items
- Place the instruments on HLD tray or container and allow air-drying before use or storage

## **Sterilization**

Sterilization is the process that eliminates all microorganisms (bacteria, viruses, fungi and parasites) including bacterial endospores from instruments. It is recommended for instruments that will be exposed to blood and tissues under the skin.

### **Types of sterilization**

#### *Steam (autoclave)*

- Decontaminate, clean and dry all instruments and other items
- Open/unlock all interlocked instruments
- Wrap instruments with two layers of paper, newsprint, or cotton materials where necessary
- Arrange all packs, drums and wrapped items in the autoclave in a way that allows free circulation of steam
- Sterilize wrapped items for 30 minutes and unwrapped items for 20 minutes, at 121°C and 106 pKa pressure
- Timing begins when desired temperature and pressure are reached
- Wait until the pressure gauge reads zero to open the autoclave
- Open the lid and allow the remaining steam to escape
- Leave instrument packs in autoclave until completely dry
- Wait until items reach room temperature before using or storing in dry, sterile, covered containers

### *Dry heat (electric oven)*

- Decontaminate, clean and dry all instruments
- Wrap instruments in double layer cotton material or place in covered metal container
- Place instrument in oven and heat to the designated temperature, e.g.
  - 170°C for 1 hour
  - 160°C for 2 hours
  - 150°C for 2½ hours
  - 140°C for 3 hours
- Once the desired temperature is reached, begin timing
- Leave instruments to cool before removing
- Remove instruments and use or store in dry sterile, covered containers

### *Chemical sterilization*

Chemical sterilization is used for instruments that are heat sensitive or when heat sterilization is unavailable.

- Decontaminate, clean and dry all instruments
- Submerge all instruments/objects completely in the solution and allow to soak for 8–10 hours – Glutaraldehyde (*Cidex*)
- Remove instruments from solution with sterile forceps or pick up
- Rinse in sterile water and air-dry
- Store in sterile container with a lid if not used immediately

*Note:* Formaldehyde can cause cancer (carcinogenic) and is extremely irritating to the skin, eyes and respiratory tract. Therefore, routine use of formaldehyde for processing instruments and other items or disinfection of environment/surfaces is not recommended.



## Housekeeping

Housekeeping generally involves cleaning and maintenance of cleanliness in health care facilities (e.g. floors, operating tables, walls, etc) to reduce the number of microorganism that may come in contact with clients or staff.

### Activities in housekeeping

#### *Preparing a disinfectant solution*

- Prepare 0.5% chlorine solution (sodium hypochlorite, *Jik* 3.5%, is diluted with one part solution to six parts clean water). Alternatives to chlorine include disinfectants containing 5% carbolic acid, such as *Phenol* or *Lysol*, or quaternary ammonium compounds. In most settings, a chlorine solution made from locally available bleach is the cheapest alternative
- Add some detergent to the 0.5% chlorine (or other disinfectant) solution and mix. Continue adding detergent until the solution is mildly foamy or bubbly

## Schedule for cleaning in client care areas

Period	Cleaning activity
At the beginning of each day	<ul style="list-style-type: none"> <li>• Clean horizontal surfaces — operating/procedure tables, examination couches, chairs, trolley, lamps, counters, and office furniture — with a cloth dampened with water and clean floors with a mop dampened with water to remove dust and lint that have accumulated overnight</li> </ul>
Between clients	<ul style="list-style-type: none"> <li>• Clean operating/procedure tables, examination couches, trolley tops, counters, lamps and any other potentially contaminated surfaces in operating theatres and procedure rooms with a cloth dampened with a disinfectant solution</li> <li>• Alternatively spray the solution onto the surface using a spray bottle and wipe with a cloth dampened with water</li> <li>• Clean spills of blood or other body fluids with 0.5% chlorine solution immediately</li> <li>• Clean visibly soiled areas of the floor, walls or ceiling with a mop or cloth dampened with a disinfectant cleaning solution</li> <li>• Put waste in a leak-proof container and empty the container when it is three quarters full</li> </ul>

Period	Cleaning activity
At the end of each clinic session or day	<ul style="list-style-type: none"> <li>• Wipe all surfaces — including counters, tables, sinks, lights, door handles, plates, and walls — with a cloth dampened with disinfectant solution or spray the solution onto the surface using a spray bottle. <i>Remember to wipe from top to bottom.</i> Pay particular attention to operating/procedure tables, making sure to clean the sides, base and legs thoroughly. Rinse sinks with clean water after cleaning.</li> <li>• Clean the floors with a mop soaked in disinfectant cleaning solution</li> <li>• Check sharps disposal containers and remove and replace them when they are three-quarters full</li> <li>• Remove medical or hazardous chemical wastes, making sure to burn or bury them as soon as possible in order to limit contact with potential infectious waste</li> </ul>
Each week	<p>To limit contact with potentially infectious waste:</p> <ul style="list-style-type: none"> <li>• Wash waste containers with disinfectant solution and rinse with water</li> <li>• Clean ceiling with mop soaked in disinfectant solution</li> </ul>

## Schedule for cleaning toilets, latrines and sluice room

Task	How to perform task	When to perform task
Clean toilets/ latrines	Use a cloth dampened with disinfectant solution	Daily or more often if visibly soiled
Clean floors	Use a mop dampened with disinfectant solution	Daily or more often if visibly soiled
Clean walls	Wipe with a cloth dampened with disinfectant solution	Daily or more often if visibly soiled
Clean ceilings	Use a mop dampened with disinfectant solution	Weekly or more often if visibly soiled
Clean sinks	Wipe with a cloth dampened with disinfectant solution and rinse with clean water	Weekly or more often if visibly soiled
Empty waste containers		Daily or more often
Clean waste containers	Wipe with a cloth dampened with disinfectant solution	Daily or more often if visibly soiled

## Cleaning up spills

When cleaning up spills:

- Always wear gloves, preferably utility gloves
- If the spill is small, wipe it with a cloth that has been saturated with a 0.5% chlorine solution
- If the spill is large, flood the area with 0.5% chlorine solution, wipe it with a cloth (or a mop if the spill is on the floor), and then clean the area with disinfectant cleaning solution
- DO NOT simply place a cloth over the spill for cleaning up later; the cloth may become soaked with the fluid, thus exposing others to potentially infectious micro-organisms. In addition, if the spill is on the floor, staff or client could easily slip and fall on it and injure themselves

## Waste disposal

Waste disposal involves getting rid of all kinds of unwanted material generated in healthcare facilities.

### Types of waste disposal

- *General waste* — uncontaminated paper boxes, packaging materials, bottles and plastic containers, etc
- *Medical waste* — blood and blood products, other body fluids, materials containing fresh or dried blood or body fluids, e.g. bandages, sharps used or unused and used IUDs
- *Hazardous chemical waste* — chemical waste, which is potentially toxic, e.g. cleaning products, disinfectants, cytotoxic drugs and radioactive compounds

### Handling waste containers

- Use non-corrosive washable containers (plastic or galvanized metal) with covers for contaminated waste

- Place waste containers at convenient places for users (carrying waste from place to place increases the risk of infection for handlers)
- *Equipment used to hold and transport wastes must not be used for any other purpose in the clinic or health care facility*
- If available use utility gloves when handling wastes
- Wash all waste containers with a disinfectant cleaning solution (0.5% chlorine solution) and rinse with water. (*Clean contaminated waste containers each time they are emptied and non-contaminated ones when visibly soiled*)
- When possible use separate containers for combustible and non-combustible wastes to prevent workers from having to handle and separate waste by hand later
- *Combustible (burnable) wastes* include paper, cardboard and contaminated wastes such as used dressings and gauze
- *Non-combustible (non-burnable) wastes* include glass, metals and plastics
- Wash hands after handling waste

### **Disposal of sharp objects (needles, razors scalpel blades)**

- Wear thick household gloves
- Dispose of all sharp items in a puncture-resistant container, which can be made of easily available materials such as a cardboard box, a tin can with lid, or a heavy plastic bottle. *Do not recap.*
- Place the container close to the area where it will be used so that workers do not have to carry sharp items for long distances before disposal
- When the “sharps” container is three-quarters full, cap, plug or tape it tightly
- Dispose of container when three-quarters full by burying. (Needles and other sharp objects may not be destroyed by burning and may later cause injuries. Incineration or

burning in a container, however, does make those items less scavengeable.)

- Wash hands after handling sharps containers.  
Decontaminate and wash gloves

*Note:* Avoid accidental needle pricks. Do not bend or break needles prior to disposal and needles should not be recapped.

### **Disposal of liquid contaminated wastes (blood, faeces, urine, and other body fluids)**

- Wear thick household (utility) gloves when handling and transporting wastes
- Carefully pour wastes down a utility sink, drain or pour into a flushable toilet. Liquid wastes can also be poured into the latrine. Avoid splashing!
- Rinse the toilet or sink carefully and thoroughly with water to remove residual wastes. Avoid splashing!
- Decontaminate specimen container with 0.5% chlorine solution or other locally available and approved disinfectant by soaking for 10 minutes before washing
- Wash hands after handling liquid waste
- Decontaminate and wash gloves

### **Disposal of solid wastes (used dressings and other items contaminated with blood and organic materials)**

- Wear thick household (utility) gloves when holding and transporting wastes
- Dispose of solid wastes in non-corrosive washable containers (plastic or galvanized metal) with tight fitting covers
- Collect the waste containers regularly and transport the combustible ones to the incinerator (if incinerator is not available, burn or bury). Bury non-combustible wastes
- Wash hands after handling wastes
- Decontaminate and wash gloves

## Disposal of used chemical containers

- Rinse glass containers thoroughly with water. Glass container may be washed with detergent, rinsed and re-used
- For plastic containers, which contained toxic substances such as glutaraldehyde (e.g. *Cidex* or *Sporicidin*), rinse three times with water and dispose by burying. *Do not reuse these containers for other purposes*

## Building a simple drum incinerator for waste disposal

- Select a site away from the direction of the wind
- Build a simple incinerator using local materials (mud or stone) or a used oil drum. The size depends on the amount of daily waste generated
- Place the burner on hardened earth or a concrete base
- Make sure the incinerator has:
  - sufficient air inlets underneath for good combustion
  - loosely placed fire bars to allow for expansion
  - an adequate opening for adding fresh refuse and for removal of ashes
  - a long enough chimney to allow for a good draught and evacuation of smoke
- Burn all combustible wastes, such as paper and cardboard, as well as used dressings and other contaminated wastes
- If the waste or refuse is wet, add kerosene so that a hot fire burns all the waste

Ash from incinerated material can be treated as non-contaminated waste



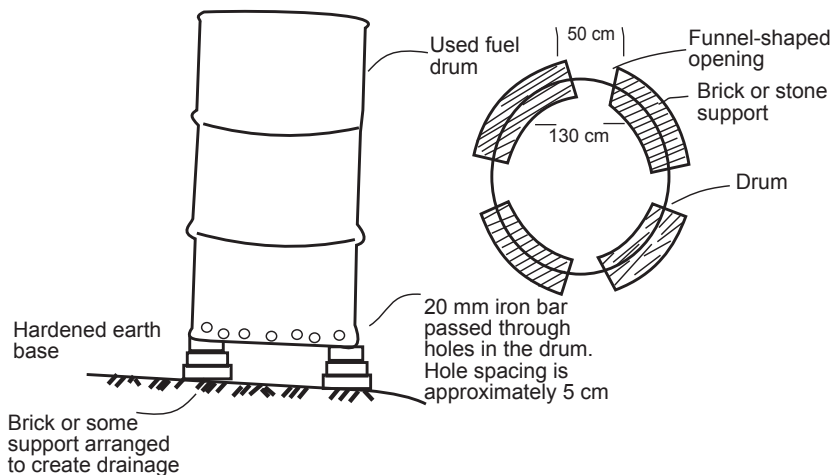


Figure 19.2: Design for a simple oil drum incinerator

## Making and using a burying site for waste disposal

- Bury in a specified location:
  - Select a site at least 50 m away from any water source, to prevent contamination of the water table
  - The site should have proper drainage, should be located downhill from any wells, and free of standing water
  - Ensure that the burial site is not in an area which floods
- Dig a pit 1 m (3–4 ft) wide and 2 m (6 ft) deep. The bottom of the pit should be 6 ft above the water table
- Cover with 15–30 cm (6–12 in) of earth each day (final cover should be 30 cm or 24 in deep)
- Fence the site to keep animals and children away

## Appendix

# Medical eligibility criteria wheel for contraceptive use

### About this wheel

This wheel contains the medical eligibility criteria for starting use of contraceptive methods. It is based on *Medical Eligibility Criteria for Contraceptive Use, 3rd edition (2004)* and its *2008 Update*, one of WHO's evidence-based guidelines. It tells family planning providers if a woman presenting with a known medical or physical condition is able to use various contraceptive methods safely and effectively. The wheel includes recommendations on initiating use of six common types of contraceptives:

1. Combined pills (low dose combined oral contraceptives, with < 35 µg ethinylestradiol)
2. Combined injectable contraceptives (Cyclofem and Mesigyna)
3. Progestogen only pills
4. Progestogen only injectables, DMPA (a three-monthly injectable) and NET-EN (a two-monthly injectable)
5. Progestogen only implants (Norplant, Jadelle, and Implanon)
6. Copper-bearing IUD

The guidance in the wheel applies to initiation of contraceptive methods. Recommendations for continuation of method use, when a woman develops a medical condition while using the method, can be found in the *Medical Eligibility Criteria for Contraceptive Use* guideline.

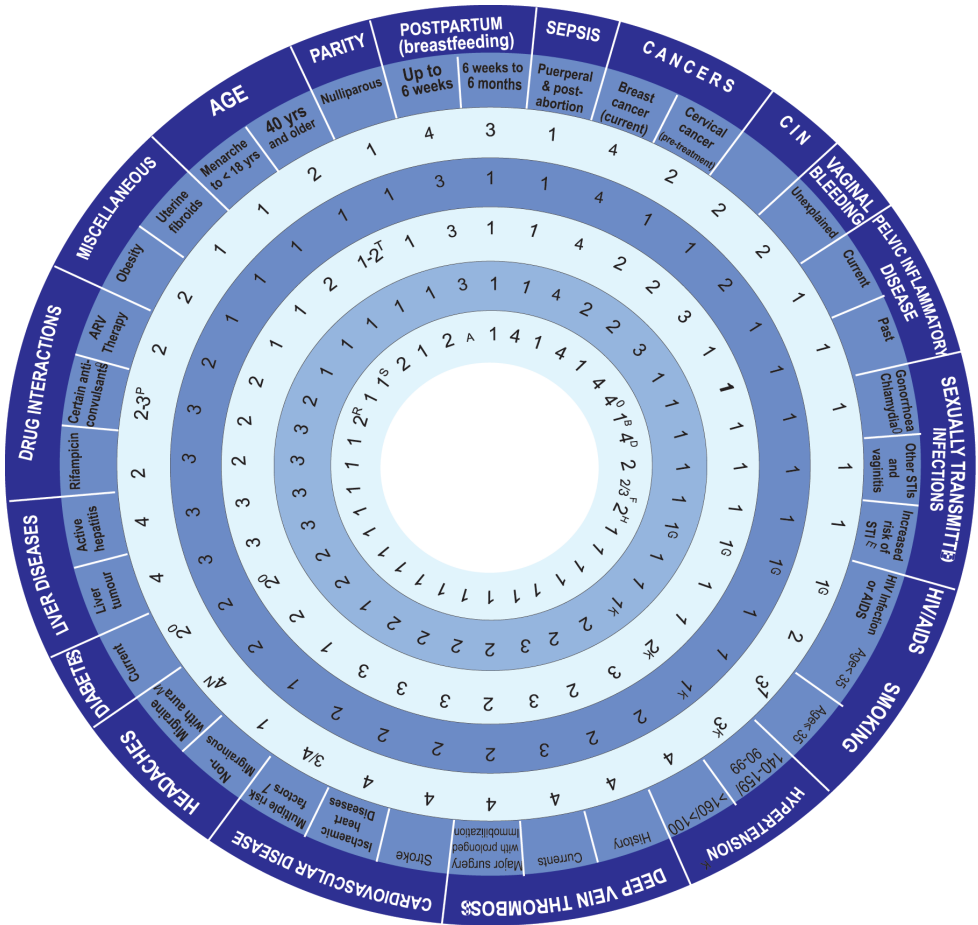
## How to use this wheel

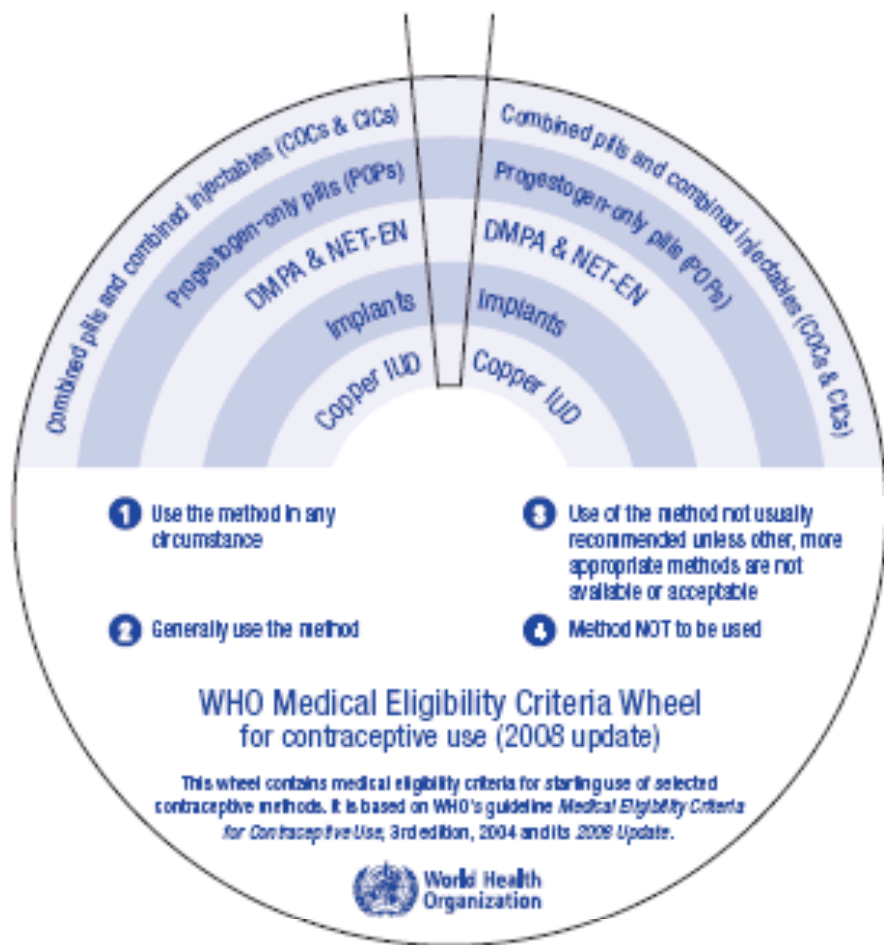
The wheel matches up the contraceptive methods, shown on the inner disk, with specific medical conditions shown around the outer rim. The numbers shown in the viewing slot tell you whether the woman who has this known condition is able to start use of the contraceptive method:

- 1 = Yes:** Use the method in any circumstance
- 2 = Yes:** Generally use the method
- 3 = No:** Use of the method is not usually recommended unless other more appropriate methods are not available or acceptable
- 4 = No:** Method NOT to be used

Categories 1 and 4 are clearly defined recommendations. For categories 2 or 3, greater clinical judgment will be needed and careful follow-up may be required. If clinical judgment is limited, categories 1 and 2 both mean the method can be used, and categories 3 and 4 both mean the method should not be used.

**No restrictions for some conditions:** There are many medical conditions when ALL methods can be used (that is, all the methods are either a category 1 or 2). These conditions are also listed.





**Conditions that are  
Category 1 and 2 for all methods (method can be used)**

<u>Age 18-39</u>	<u>High risk for HIV</u>	<u>Schistosomiasis (bilharzia)</u>
<u>Anaemias, including sickle-cell disease and thalassemia</u>	<u>History of gestational diabetes</u>	<u>Surgery without prolonged immobilization</u>
<u>Benign ovarian tumors, including cysts</u>	<u>History of high blood pressure during pregnancy</u>	<u>Taking antibiotics (excluding rifampicin) or griseofulvin</u>
<u>Breast disease: family history, benign breast disease and undiagnosed mass</u>	<u>History of pelvic surgery, including cesarean section</u>	<u>Thyroid disorders</u>
<u>Depression</u>	<u>Irregular, heavy or prolonged menstrual bleeding</u>	<u>Tuberculosis (but if pelvic, cannot use IUD)</u>
<u>Dysmenorrhoea</u>	<u>Malaria</u>	<u>Uncomplicated valvular heart disease</u>
<u>Endometriosis</u>	<u>Metrodosis</u>	<u>Varicose veins</u>
<u>Epilepsy</u>	<u>Past ectopic pregnancy</u>	<u>Viral hepatitis (not active)</u>
	<u>Post-abortion (no sepsis)</u>	

**Notes to the conditions**

- |  |   |
|--|---|
| <p><b>A</b> Can insert copper IUD &lt; 48 hrs after delivery or &gt; 4 weeks</p> <p><b>B</b> If she had no subsequent pregnancy, IUD= 2.</p> <p><b>C</b> Or other forms of purulent cervicitis, IUD = 2.</p> <p><b>D</b> If she develops this condition while using the IUD, she can keep using it during treatment</p> <p><b>E</b> If at increased risk of STIs or HIV, advise condom use.</p> <p><b>F</b> If very high likelihood of exposure to gonorrhoea or chlamydia = 3</p> <p><b>G</b> If on ARV Therapy = 2</p> <p><b>H</b> AIDS, but not clinically well on ARV Therapy = 3 for insertion.</p> <p><b>I</b> COCs and heavy smoking = 4. CICs and light smoking = 2</p> <p><b>J</b> If blood pressure cannot be measured, and she has no known history of hypertension, all methods can be used.</p> <p><b>K</b> The same category applies to controlled hypertension.</p> <p><b>L</b> Risk factors include: older age, smoking, diabetes, hypertension.</p> | <p><b>M</b> To check if migraine has aura, ask: "Do you see a bright spot in your vision before bad headaches?"</p> <p><b>N</b> Migraine without aura and &lt;35 years old, COCs abd CICs = 2. Migraine without aura and ≥ 35 years, COCs and CICs = 3.</p> <p><b>O</b> For complicated diabetes, or having diabetes for more than 20 years, COCs, CICs, DMPA and NET-EN = 3-4.</p> <p><b>P</b> COCs= 3, CICs= 2.</p> <p><b>Q</b> Phenytoin, carbamazepine, barbiturates, primidone, topiramate, oxcarbazepine.</p> <p><b>R</b> If she is not clinically well, IUD = 3.</p> <p><b>S</b> If the urine cavity is distorted, cannot use IUD.</p> <p><b>T</b> &gt; 45 yrs. = 2.</p> |
|--|---|

Developed in collaboration with:



© World Health Organization, 2006



