



















## **B. Key Elements for Quality Family Planning Service Delivery**

Assuring the good quality of family planning services is a human right and an ethical obligation of health care providers. To ensure good quality of care, the service provider should uphold and fulfil clients' rights which include the right to information, access to services, choice, safety, privacy and confidentiality, dignity and comfort, continuity of services, and opinion.

Likewise, quality of care also depends on the needs of service providers. To achieve quality services, the needs of service providers must be met as well. These include the needs for: training, information, proper infrastructure and supplies, guidance, backup, respect and encouragement, feedback on their performance, and opportunities for self expression.

### **The 10 Clients Rights**

#### **1. Right to Information**

All individuals have a right to: information on the benefits of family planning for themselves and their families and to know where and how to obtain more information family planning at and outside the facility to be able to make informed choices of their method of preference.

Service providers should ensure provision of accurate non-biased family planning and other related reproductive health information and education is provided to clients and the community.

#### **2. Right to Access**

All individuals have a right to receive services from family planning programs, regardless of their socio-economic situation, religion, political belief, ethnic origin, age, marital status, geographic location or other characteristics which may place individuals in certain groups. This right means a right of access through various health care providers as well as service delivery systems.

#### **3. Right of Choice**

Individuals and couples have the right to decide freely whether or not to practice family planning. When seeking contraceptive services, clients should be given the freedom to choose which method of contraception to use. Clients should be able to obtain the method they have decided to use provided there are no significant contraindications to their use of the method. Clients' decisions discontinue or switch methods should be respected. Clients also have a right to choose where to go (physical location or a choice of service delivery mode; e.g., community family planning or health worker, pharmacy or over-the-counter service, hospital, health center or family planning clinic) for family planning services and the type of service provider with whom they feel most comfortable

Service providers should assist clients to make informed choices of their method of preference by providing unbiased information, education and counseling, as well as an adequate range of contraceptive methods at appropriate levels of the health system.

#### **4. Right to Safety**

All individuals have a right to safety in the practice of family planning, effective contraception and protection against other health risks not related to a method of contraception, for example against the possibility of acquiring an infection through the use of contaminated instruments.

## **5. Right to Privacy**

All family planning clients have the right to privacy in discussing and attending to his/her needs or concerns. The client also has the right to refuse any particular type of examination if s/he does not feel comfortable with it or to request this examination be done by another provider.

The service provider should maintain visual and auditory privacy, confidentiality, respect and client dignity during counselling. Physical examination should be carried out in an environment in which his/her privacy is respected.

## **6. Right to Confidentiality**

The confidentiality of information provided or details of the services received by family planning clients needs to be assured and should not be communicated to third parties without the client's consent. The right to confidentiality is protected under the Hippocratic Oath.

A breach of confidentiality could cause: the client to be shunned by the community, matrimonial adverse status, lessen a target group's confidence and trust in the staff of a service delivery program.

The service provider should not talk about clients by name or in the presence of other clients. The service provider should not discuss clients outside service sites. The service provider should keep client's records closed and filed immediately after use and control access to client records.

## **7. Right to Dignity**

All family planning clients should be treated with courtesy, consideration, attentiveness, and respect regardless of their level of education, social status or any other characteristics

Service providers must put aside their personal gender, marital, social and intellectual prejudices and attitudes while providing services.

## **8. Right to Comfort**

Making the client feel comfortable when receiving services with regards to adequacy of service delivery facility and quality of services, e.g. proper ventilation, lighting, seating and toilet facilities, short waiting time and the environment is in keeping with the cultural values, characteristics and demands of the community.

## **9. Right of Continuity**

Clients: should receive services and supplies of contraceptives for as long as they need them should have unconditional access to other services within and without the facility has a right to request transfer of his/her clinical record to another clinical facility, (copy of records be sent to that facility or given to the client). Linkages, referral and follow up are very important aspects of a client's right to continuity of services, for example, having the same provider help the client at different visits, and even , as much as possible having only one provider doing the history, the counselling and the examination rather than having this done by different people.

## 10. Right of Opinion

The providers should view positively the clients' opinions on the quality of services (in the form of thanks or complaint, suggestions for changes in the service provision) and include in the program's ongoing effort to monitor, evaluate and improve its services.

Involvement of the client's opinions at the planning stage aims at satisfying the would-be clients' need and preference appropriately and acceptably.

### Providers' Needs

In order for the provider to offer quality services s/he has needs that must be fulfilled

1. *Training* on technical and communication skills
2. *Information* on technical issues, updated regularly
3. *Infrastructure*, including appropriate physical facilities and efficient organization
4. *Supplies* of contraceptives, equipment, and educational materials
5. *Guidance* from service guidelines, checklists, supervision
6. *Back-up* from other providers and levels of care
7. *Respect* and recognition from co-workers, managers, clients, and community
8. *Encouragement* to provide quality services
9. *Feedback* from managers, supervisors, other service providers, and clients.
10. *Self-expression*, managers should consider service providers views when making decisions

## C. Roles of trained health care providers at different service delivery levels

### Community level

- ◆ Provide IEC to women, men, adolescents, and communities about the health benefits of:
  - Delaying first pregnancy.
  - Birth spacing and limiting family size.
- ◆ Counsel clients for informed choice of family planning (FP) methods.
- ◆ Provide contraceptive pills and barrier methods (condoms, foams, jellies).
- ◆ Record community-based health information (e.g. number of new clients for FP).
- ◆ Refer clients for other FP services as necessary

### Dispensary level

As at community level, plus:

- ◆ Obtain targeted history
- ◆ Perform physical examination.
- ◆ Screen for STI and treat as necessary.
- ◆ Provide method of choice, including IUCD and injectable.
- ◆ Refer as needed.

## Health centre level

As at dispensary level, plus:

- ◆ Provide Implant insertion and removal.
- ◆ Refer clients who desire surgical sterilization.

## Hospital level

As at health centre level, plus

- ◆ Perform surgical sterilisation.

## D. Clinic Organisation

Clinic organisation is the clinic arrangement that facilitates maximizing access and quality of services provided

### Purposes of clinic organisation

- ◆ To create a comfortable environment which will result in acceptances and continued use of the services.
- ◆ To attract new clients and retain those who are already using services.
- ◆ To provide consistent and uniform services.
- ◆ To increase and sustain the re-liability of the clinic.
- ◆ To improve the reputation of the clinic and health care providers.

### Factors that enhance efficient and safe environment

#### *Physical setting:*

- ◆ General cleanliness and good ventilation.
- ◆ Comfortable waiting area with adequate sitting space, free from rain or direct sun.
- ◆ Adequate rooms/space to ensure privacy for offering different services.
- ◆ Availability of safe drinking water.
- ◆ Availability of clean toilets/latrines and handwashing facilities, i.e. water and soap.
- ◆ Space for processing used instruments and materials.
- ◆ Easy accessibility and safe storage of equipment and supplies, free from contamination and danger.

#### *Client flow:*

- ◆ Ensure the client flow pattern is clear and not confusing to clients, e.g. put notice on doors or guide all clients to appropriate services.
- ◆ Avoid unnecessary waiting time, e.g. give numbered cards.
- ◆ Give appointments and adhere to appointment given (clients who come without appointments, serve on first come first served basis).
- ◆ Occupy clients with reading materials, video shows, health education talks etc.
- ◆ Assist clients being referred internally or externally.
- ◆ Give clients return visit dates as appropriate.

### ***Providers' Technical competence:***

- ◆ Ensure that providers have necessary competencies for the job they are required to do
- ◆ Ensure updates by sharing information, conducting on job training and supporting each other.
- ◆ Ensure supportive supervision of staff/co-workers
- ◆ Maintain FP/RCH service guidelines and standards for service provision.
- ◆ Adhere to infection prevention measures, e.g. proper disposal of soiled materials, sharp needles and syringes.

### ***Maintenance of FP/RCH supplies:***

- ◆ Ensure method mix (variety of FP methods) as stipulated in National Policy Guidelines per type of health facility.
- ◆ Ensure availability of adequate stock which is not expired or damaged.
- ◆ Ensure RCH supplies are easily accessible to all providers.
- ◆ Follow storage guidelines
- ◆ Conduct physical inventory of supplies.

### ***Maintenance of client and clinic records:***

- ◆ Maintain privacy and confidentiality of clients information.
- ◆ Use proper filing for easy retrieval and identification.
- ◆ Record information clearly so that any one can read and understand.

### ***Proper Time management:***

- ◆ Allow sufficient time for client/provider interaction.
- ◆ Prepare in advance where possible.
- ◆ Avoid routines that inconvenience clients, (e.g. must wait for instrument to be sterile) before getting services quickly and efficiently.

### ***Location of the facility/services:***

- ◆ Located within access and, if possible, close to or combined with related services.

### ***Maintenance of FP/RCH equipment:***

- ◆ Make available basic FP/RCH equipment.
- ◆ Maintain inventory of equipment.
- ◆ Handle equipment carefully to avoid damage, e.g. make time for thorough processing/maintenance of equipments,
- ◆ Use JIK disinfectant or other solutions according to instructions.
- ◆ Store equipment carefully.

### ***Maintenance of FP/RCH - IEC materials:***

- ◆ Ensure IEC materials available:
  - make sure they are in working order
  - order according to need
  - repair damaged IEC materials promptly
  - store in safe place away from direct sunlight.
- ◆ Keep record of visual aids available.
- ◆ Understand the purpose and how to use them.
- ◆ Use IEC material according to instructions.

## E. Record Keeping and Logistics Management in FP Services

### Record Keeping

#### Purposes of Record keeping

- To show numbers of supplies and equipment.
- To help determine whether services provided need to be expanded.
- To help determine relevance of competence of service providers.
- To help calculate supplies used and needed.
- To help assess improvement of service quality between two periods e.g. before and after training.
- To have a record of client's use of FP/RCH services on which to compare quality of care e.g.
  - FP method mix.
  - Referrals.
  - Other FP/RCH services.
- To be used as a legal document if needed.
- To provide information on client services available at the facility.
- To help service providers evaluate services provided.
- To help service provider make up appropriate quality improvement or changes

#### Types of records and reports

##### ◆ *Equipment and supplies records.*

- RCH No. 5 Family Planning card.
- MTUHA Book No. 8 day-to-day.
- Appointment card.
- Ledger book for FP methods and equipment.
- Report and request for contraceptives.
- Amount of contraceptives issued.

##### ◆ *Clinic records*

- MTUHA Book No. 10 for monthly, quarterly and annual reports.
- MTUHA Book No. 2 for SDP service statistics.
- MTUHA summary sheet table No. 3 for amount of contraceptive-used on monthly basis to be totaled yearly.

## **Important factors in record keeping**

- Accurate filling of records
- Proper maintenance of records.
- Review of records/data to monitor progress.
- Analyse and interpret data.
- Use of records/data to evaluate services and make appropriate quality improvement changes.

## **Reporting system for FP services**

Services providers should use the following forms/books

- MTUHA Book No. 8 to report to the CHMT on client data.
- Report and Requisition (R & R) forms to report client statistics and logistics supply.
- Reporting system as spelled out in the MOH-FP Logistics Management Guidelines.

## **Submission of reports**

Reports should be submitted to:

- SDP (service Provider/facility Incharge).
- District level (DRCHC/CHMT).
- Regional Level (RRCHC/RHMT).
- National level (HMIS Unit).

## **Uses of client and clinic data in tables graphs and bar charts**

- To show key information easily.
- For comparison purposes.
- To show pattern and trends.
- For attention attraction.
- For tabulation
- For statistical information.

## **Logistics Management**

### **Purposes of FP/RCH logistics management**

- To determine contraceptive supply needs.
- To order, receive and store contraceptives properly.
- To distribute and maintain adequate contraceptive supplies.
- To record and report accurate information about contraceptive supplies and their use.
- Monitor logistics activities and supervise the personnel who carry them out.
- Ordering according to stock available and demand.
- Proper storage.
- Proper control and maintenance of equipment and supplies.
- Issuing according to First-Expiry First-Out

## **Levels of the logistics system**

- Central MSD level.
- Zonal MSD.
- District Health Management level.
- Facility level.

## **The six “rights” of logistics system**

- Right goods.
- Right qualities.
- Right condition.
- Right place
- Right time.
- Right cost

## **Roles of service providers in logistics**

### ***Management***

- Enter all supplies and Equipment received in ledger book.
- Store contraceptives and other equipments following accepted storage guidelines.
- Make entries in RCH No 5 lead and MTUHA Book 8 accurately and timely.
- Conduct physical inventory of contraceptives and other commodities monthly.
- Determine commodities according stock available.
- Order commodities according stock available and required using R & R and other request documents.
- Work with in charge of the facility to complete monthly and quarterly reports and submit to district

## **Issues for consideration in monitoring, evaluation and logistics management**

- Completeness and accuracy of records for ease of analysis and use.
- Analyzing data, identifying problems and root cause.
- Sharing findings at all levels.
- Taking actions to improve.
- Involve all providers.
- Asking for clients inputs in results of monitoring and why some areas may not be doing well.
- Proper storage.
- Proper controlling and maintaining of equipment.
- Ordering according to stock available.



## CHAPTER 2:

# INFECTION PREVENTION IN FAMILY PLANNING SERVICE DELIVERY

### Overview:

Infection is one of the leading causes of morbidity and mortality in Tanzania. Moreover it is one of the top causes of maternal deaths in our country. Infection prevention is therefore, not only the pillar but a cornerstone for the delivery of high quality services worldwide. Consequently, addressing quality improvement in family planning and reproductive health services in the country through infection prevention is mandatory and cannot be overemphasized. The main aim of this chapter is to equip the service providers and trainees with the pre-requisite knowledge and skills regarding infection prevention and the etiquettes of handling family planning and reproductive health procedures so as to maximise quality of services offered to clients. It is extremely important that the service provider understands and adheres to laid down standard precautions while carrying out procedures so as to minimise chances of spreading infections to clients or contracting infections from them. Infection also jeopardizes the quality of the standard of services expected. The aim of infection prevention practices are to; protect clients from nosocomial infections, protect health care workers from occupational exposure to infections, protect clients from non occupational exposure to infections, protect communities from infectious diseases and prevent environmental pollution.

## Definition of terms and Concepts:

**Asepsis** or **aseptic technique** are general terms used in health care settings to describe the combination of efforts made to prevent entry of microorganisms into any area of the body where they are likely to cause infection. **The goal of asepsis is to reduce or eliminate the number of microorganisms on both animate (living) surfaces (skin and tissue) and inanimate objects (e.g. surgical instruments) to a safe level.**

**Antisepsis** is the prevention of infection by killing or inhibiting the growth of microorganisms on skin and other body tissues through the use of a chemical agent (antiseptic).

**Decontamination** is the process that makes inanimate (non-living) objects safer to be handled by staff (especially cleaning personnel) **before cleaning**. Such objects include large objects (e.g., examination tables) and surgical instruments and gloves contaminated with blood or body fluids during or following medical procedures.

**Cleaning** is the process that physically removes all visible blood, bodily fluids, or any other foreign material such as dust or soil from skin or inanimate objects.

**Disinfection** is the process that eliminates most, but not all disease-causing microorganisms from inanimate objects. **High-level disinfection (HLD)**, through boiling or the use of chemicals eliminates all microorganisms except some bacterial endospores.

**Sterilization** is the process that eliminates **all** microorganisms (bacteria, viruses, fungi, and parasites), including bacterial endospores from inanimate objects.

## Standard Precautions

**Standard precautions**; are a simple set of effective practice guidelines (creating a physical, mechanical or chemical barrier) to protect health service providers and clients/patients from infection with a range of pathogens including blood borne.

## Components of Standard Precautions:

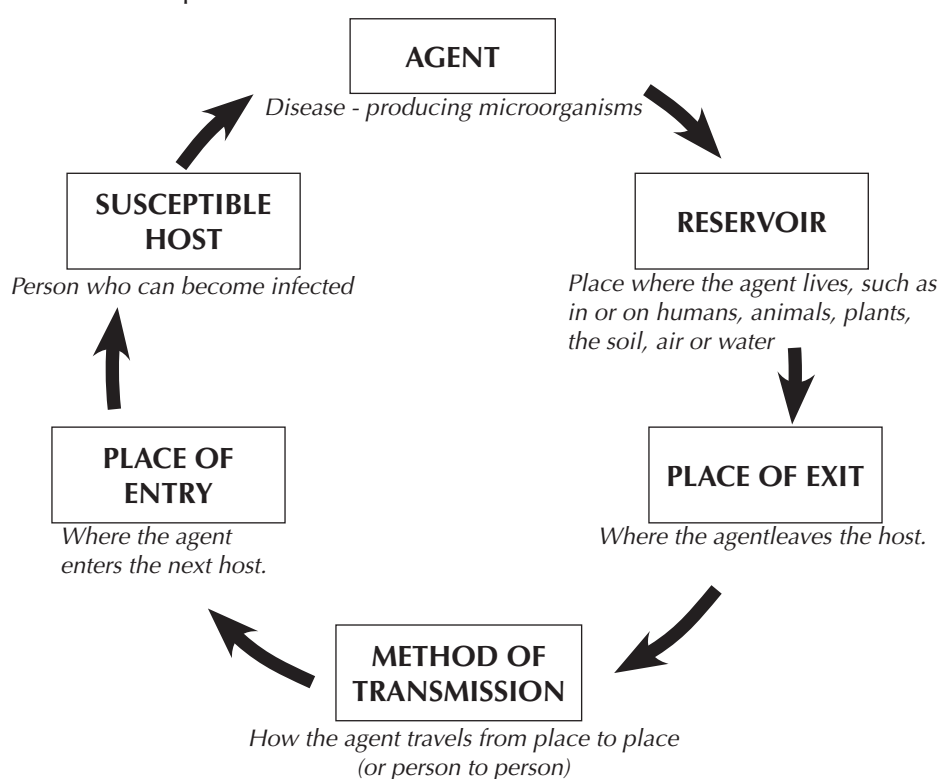
- Consider every person (patient or staff) as potentially infectious and susceptible to infection.
  - **Consider dead bodies as also potentially infectious.**
  - Because it is not possible to know in advance if a client has an infection such as hepatitis B or HIV, **all items from all clients must be handled as if they are contaminated and all clients treated as if they may be infected.**
- Use appropriate hand hygiene e.g. hand washing, hand antiseptics, antiseptic hand rub and surgical hand scrub
- Wear personal protective equipment (PPE) e.g. gloves, masks, goggles, caps.
- Handle sharps, patient care and resuscitation equipment, linen appropriately
- Manage patient placement and patient environmental cleaning appropriately
- Dispose of infectious waste materials safely to:
  - protect those who handle them and
  - Prevent injury or spread to the community
- Process instruments by decontamination, followed by, cleaning, and sterilization or high level disinfection.

## How standard precautions break the disease transmission cycle:

There are four ways in which standard precautions break the disease transmission cycle. These are;

1. Reduction of the number of infection-causing micro-organisms present eg by practising hand hygiene, cleaning instruments etc
2. Killing or inactivating infection-causing micro-organisms by hand washing with an antiseptic.
3. Creating barriers to prevent infectious agents from spreading by wearing PPE or covering the mouth when sneezing and
4. Reducing or eliminating risky practices by passing sharps using hands-free techniques, using disposable gloves instead of none etc.

The diagram of the disease transmission cycle shows the steps in the transmission of an infection such as hepatitis B (HBV) and AIDS (HIV) viruses.



## Six components of the disease transmission cycle

In order for diseases to move from person to person the following conditions must exist:

- **Agent** (micro organism that produces disease)
- **Reservoir** (place where agent lives such as in or on humans, animals, plants, the soil, air or water)
- **Place of exit** (where the agent leaves the host)
- **Method of transmission** (how the agent travels from place to place or person to person)
- **Place of entry** (where the agent enters the next host)
- **Susceptible host** (person who can become infected)

The cycle repeats itself; infectious diseases are prevented by breaking the cycle.

## Hand Hygiene

Hand hygiene is an action intended to prevent hand-borne infections by removing dirt and debris and inhibiting or killing microorganisms on skin. It includes care of hands, nails and skin.

### Types of hand hygiene

There are four types of hand hygiene with different uses for each. They include:

- Routine hand washing
- Hand antisepsis
- Alcohol hand rub and
- Surgical hand scrub

- 1. Hand Washing:** is a process which mechanically removes dirt and debris from skin and reduces the number of transient micro organisms. Hand washing is the simplest and most important infection prevention procedure in any clinic. It removes many microorganisms from the skin, which helps to prevent transmission of infections from person to person.

It is always important to remember that if tap water is contaminated, use water that has been boiled for 10 minutes and filtered to remove particles(if necessary), or use chlorinated water, that is -water treated with a dilute bleach solution (sodium hypochlorite ) to make the final concentration 0.1 percent.

### Hand washing should be done:

*Before:* The day's work; examining a client; administering injections or drawing blood; performing a procedure (IUD or pelvic exam); handling clean, disinfected, or sterilized supplies for storage; putting on sterile gloves; going home.

*After:* Any situation in which the hands may be contaminated, such as handling instruments or touching body secretions or excretions; removing gloves; personal use of toilet; blowing nose, sneezing, or coughing.

It is important that hands should be washed with soap and water(or an antiseptic hand rub can be used) after removing gloves because the gloves may have tiny holes or tears, and bacteria can rapidly multiply on gloved hands due to the moist and warm environment within the glove.

### Steps:

1. Thoroughly wet hands
2. Apply a hand washing agent like liquid soap.
3. Rub all areas of hands and fingers for 10-15 seconds paying particular attention to nails and between fingers.
4. Rinse hands thoroughly with clean running water from a tap or bucket.
5. Dry hands with paper towel or a clean, dry towel or air-dry them.
6. Use a paper towel or clean, dry towel when turning off water when there is no foot control or automatic shut off.

## Handwashing Technique with Soap and Water



## 2. Hand Antisepsis

**Hand antisepsis** removes soil and reduces or slows the growth of both transient and resident flora on the hands. The technique is similar to plain hand washing except that it involves the use of an antiseptic agent instead of liquid soap.

Hand antisepsis should be performed **before**:

- Examining or caring for highly susceptible patients (e.g., premature infants, elderly patients, those with advanced AIDS);
- Performing an invasive procedure such as insertion of the IUD; and
- Leaving the room of patients with infections that can be transmitted through contact (e.g., flu, hepatitis A or E) or who have drug resistance infections (e.g., methicillin-resistant *S. aureus* [MRSA]).

### 3. Antiseptic Hand Rub (Alcohol hand rub)

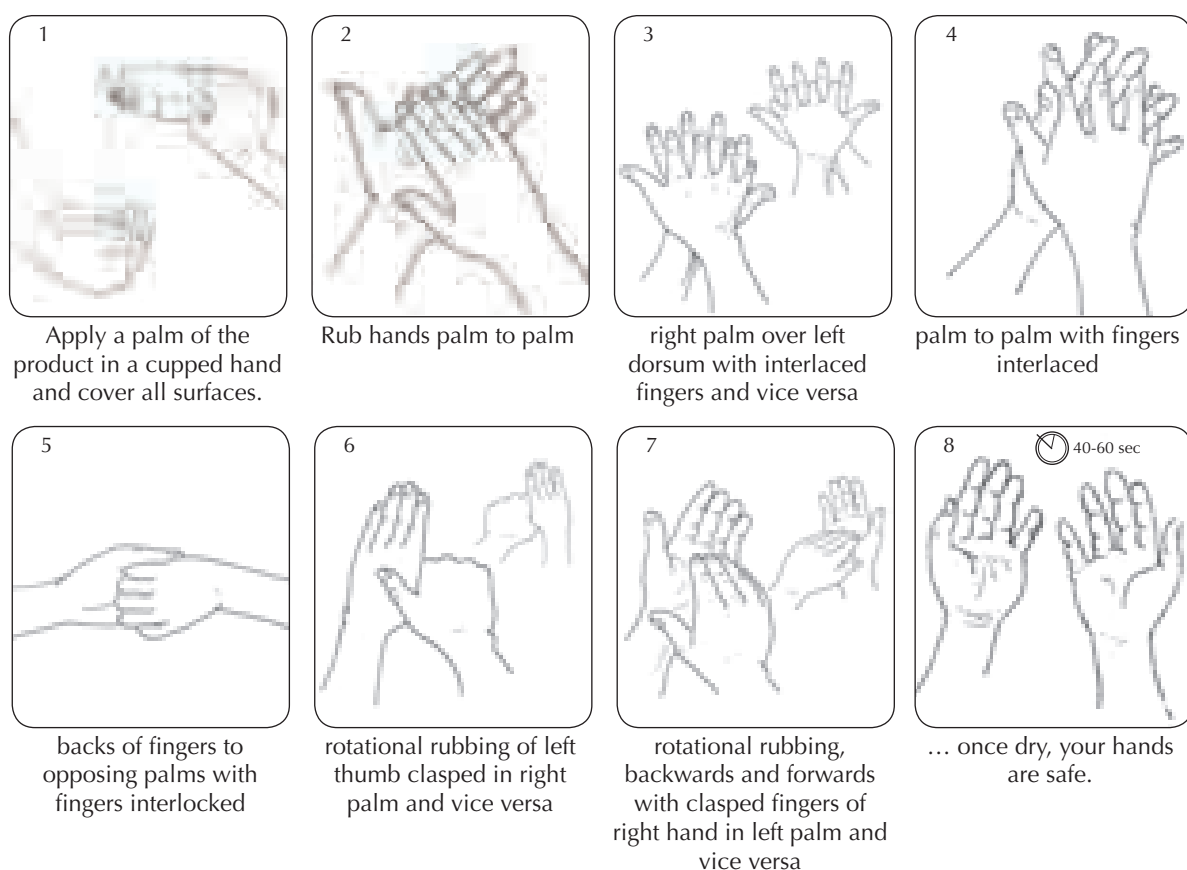
This process inhibits or kills transient and resident flora. Isopropyl or ethyl alcohol 70% can be used to clean hands and is more effective in killing transient and resident flora than antimicrobial hand washing agents or plain liquid soap and water when hands are not visibly soiled. Alcohol makes the skin dry, but a non-irritating alcohol solution

#### How to make Alcohol Hand rub

To make your own, low cost hand rub, combine:

- 100 ml of 60-90% Ethyl or Isopropyl Alcohol and
- 2 ml of Glycerin
- Shake and then it's ready for use!

#### Hand Hygiene Technique with Alcohol-Based Formulation



#### The technique involves:

- Applying enough alcohol-based hand rub to cover the entire surface of hands and fingers (about a teaspoonful or 5 cc).
- Rub the solution vigorously over the hands (covering thumbs, palms and backs of hands including between fingers, tips of fingers and under nails) until thorough dry.

### 4. Surgical Hand Scrub

The process mechanically removes dirt, debris and transient organisms reduces resident flora prior to performing any invasive surgical procedure for the duration of the procedure. The goal is to prevent surgical area contamination by microorganisms from hands and arms of the surgeon and assistants.

The steps of surgical hand scrub include;

- Remove rings, watches and bracelets
- Thoroughly wash hands and forearms to the elbows with liquid soap and water.
- Clean under the nails
- Rinse with clean, running water thoroughly
- Apply an antiseptic agent
- Continuously rub all surfaces of hands, fingers and forearms with the antiseptic agent for at least 2 minutes
- Rinse hands and arms thoroughly with clean water, holding hands higher than the elbows
- Keep hands up and away from body, do not touch any surface or article, and dry hands with sterile dry towel or air dry.
- Put sterile surgical gloves on both hands.

### **Use of Personal Protective Equipment (PPE):**

PPE are mechanical barriers that help prevent the spread of microorganisms from person to person (patient, health care client or health worker) and equipment, instruments and environment and community. PPE includes caps, eye wear, masks, aprons, gowns, gloves, scrub suits/gowns, drapes and boots or closed shoes. Because this manual focuses on FP, only gloves will be discussed in detail )

### **Gloves**

**Gloves are used to protect the health care provider** from contact with potentially infectious substances and to protect the client or patient from infections which might be found on the skin of the health care provider. They are the most important physical barriers for preventing the spread of infection. There are three types of gloves: Surgical gloves ( sterile/single use), disposable examination gloves, heavy duty/house hold utility gloves.

### **Observe the following when using sterile gloves:**

- In the Family Planning setting, sterile gloves are only needed for a surgical procedure, such as inserting implants or for a minilaparotomy, otherwise examination gloves are sufficient.
- Use a separate pair of gloves for each client to avoid cross-contamination.
- Do not use gloves from a package that is broken or expired
- Do not use gloves which are cracked, peeling or have holes or tears.
- Never touch the outside of the gloves while putting them on; handle them only by the out-turned inner cuff.
- If gloves accidentally become contaminated, change them immediately.
- Wash hands after gloves are removed at the end of client contact.

**Note:** *Adjusting the cuff of one glove will contaminate the fingers of the other hand.*

### **Steps for putting on gloves**

1. Decontaminate the surface where gloves will be opened.
2. Obtain the correct size of gloves.
3. Wash hands and dry well. Lightly powder hands (not gloves) if inside of gloves are not powdered.\*
4. Open other sterile supplies (e.g., open end of IUD package).

5. Open outer glove wrapper and lay the glove package out on a clean surface, with cuffs facing you. (This should be the bottom edge of the packet.) Take care not to touch the inner surface of the wrapper if you intend to use it as a sterile field.
6. Pick up a glove by the folded-back cuff. Be careful to touch only the inside portion of the cuff (i.e., the side which will be touching your skin when the glove is on).
7. While holding the glove, slip the other hand into the glove. Pointing the fingers of the glove to the floor will keep the fingers open by force of gravity. Be careful not to touch anything; holding the gloves above waist level will help.
8. If the first glove is not fitting correctly, wait to make any adjustments until the second glove is on. (Then you can use the sterile fingers of one glove to adjust the sterile portion of the other.)
9. To pick up the second glove, slide the fingers of the gloved hand between the folded cuff and the sterile portion of the second glove. This is very important, in order to avoid contaminating the gloved hand with the un-gloved hand.
10. Place the second glove on the ungloved hand by maintaining a steady pull through the folded cuff.
11. Do not attempt to adjust cuffs once the gloves are on, since this may cause the gloves to become contaminated.
12. Adjust the position of the glove fingers until the gloves fit comfortably.
13. Always keep gloved hands above the waist level and in sight to avoid accidental contamination.
14. If a glove becomes contaminated, stop and ask yourself if the glove will touch a sterile or disinfected instrument, the client's mucous membranes or sterile tissue. If yes, either remove that glove and re-glove, or put another sterile glove over the contaminated glove.

**Note:**

\*Do not use powder for insertions of implants because the powder will adhere to the silastic capsule, causing a foreign body reaction.

### Steps for removing used gloves:

1. When removing gloves, avoid allowing the surface that was sterile to come into contact with your hands (the exterior of the gloves is now contaminated).
2. Dispose of gloves in a waste container for contaminated waste
3. Grasp one of the gloves near the cuff and pull it partway down. The glove will turn inside out.
4. With the first glove still covering your fingers, grasp the second glove near the cuff and pull it part way down. The glove will also turn inside out.
5. Pull off the two gloves at the same time.
6. Dispose the gloves in a waste bin.
7. Wash hands immediately, with liquid soap and running water.

**Aprons:** Rubber or plastic aprons provide a protective waterproof barrier of the health and social welfare workers during their course of work

**Protective eyewear:** Eyewear protects the eyes from accidental splashes of blood or other body fluids. These must be used when splashes of blood or body fluids are anticipated such as in labour and delivery wards, surgical or casualty units. Example of eyewear include: plastic goggles, safety glasses, face shields, or visors.

**Boots:** Rubber boots provide protection to the feet from injury by sharps or heavy items (that may accidentally fall) as well as splashes of blood and other body fluids. Boots must be decontaminated after use and kept dry. Avoid wearing sandals or shoes made of soft materials.



## Antiseptics

Antiseptics are chemicals which kill or inhibit many, though not all, microorganisms while causing little damage to tissue. Cleaning the client's skin with antiseptic solution is an important infection prevention measure.

### *Types of Antiseptics*

- Alcohol-based solutions (tinctures) of iodine or chlorhexidine
- Alcohols (60–90% ethyl, isopropyl or “methylated spirit”)
- Chlorhexidine gluconate (2–4%) (e.g., Hibitane®, Hibiscrub®, Hibiclens®)
- Chlorhexidine gluconate and cetrimide, various concentrations at least 2% (e.g., Savlon®)
- Iodine (3%); aqueous iodine and alcohol-containing (tincture of iodine) products
- Iodophors (7.5–10%), various other concentrations (e.g., Betadine®)
- Chloroxylonol (Para-chloro-metaxylonol or PCMX) (0.5–3.75%), various other concentrations (e.g., Dettol®)
- Triclosan (0.2–2%)

Antiseptic solutions should be used in the following situations:

- Surgical handscrub
- Skin or vaginal preparations for procedures such as minilaparotomy, laparoscopy, vasectomy, implant insertion or removal, IUD insertion and injections.
- Handwashing before touching clients who are unusually susceptible to infection, such as newborns or immunosuppressed persons.

### **Remember:**

- Alcohol should never be used on mucous membranes because it burns the membranes.
- Zephiran (benzalkonium chloride) should not be used as an antiseptic, because it takes at least 10 minutes to kill HIV. Solutions of benzalkonium chloride have repeatedly been shown to become contaminated by pseudomonas and other bacteria. Solutions of benzalkonium chloride are easily inactivated by gauze and other organic material.
- Antiseptics are for skin or mucous membranes only. They are not designed for use on inanimate objects such as operating tables, equipment, or instruments.

## Steps for Skin and Mucous Membrane Preparation

### **Prior to Surgical Procedures**

- **Do not remove hair from the operative site unless absolutely necessary.** If hair removal must be done, trim the hair close to the skin surface immediately before surgery. **Shaving increases the risk of wound infection**, since the tiny nicks in the skin provide an ideal setting for microorganisms to grow and multiply.
- Ask the client about known allergic reactions before selecting an antiseptic solution.
- If visibly soiled, thoroughly clean the client's skin or external genital area with soap and water or have her clean it before applying antiseptic.
- Thoroughly clean the skin using antiseptic by gently scrubbing. Work from the operative site outward for several inches. (A circular motion from the centre out helps to prevent recontamination of the operative site with local skin bacteria.)
- **Do not allow the antiseptic to pool** beneath the client's body. (This reduces skin irritation.)
- Allow the antiseptic to dry before beginning the procedure. If using an iodophor, wait one to two minutes before proceeding to allow time for the iodine to be released.

## Vaginal Preps

For vaginal preps, prior to IUD insertion or removal, select a water-based antiseptic such as an iodophor or chlorhexidine gluconate (Hibiclens or Savlon). Do not use alcohols; they burn and irritate mucous membranes, promoting the growth of microorganisms.

- Ask the client about known allergic reactions before selecting an antiseptic solution.
- If visibly soiled, thoroughly clean the client's skin or external genital area with soap and water or have her clean it before applying antiseptic solution.
- Apply an antiseptic solution to the perineum.
- After inserting the speculum, apply the antiseptic solution liberally to the vagina and cervix (two or three times) using dry, disinfected forceps and cotton soaked in the antiseptic. Clean from the inside of the cervical os outward.
- If iodophors are used, allow one to two minutes before proceeding (iodophors require up to two minutes contact time to release free iodine).

## Skin Preparation for Injections

If the injection site is dirty clean with soap and water

## Proper Handling Soiled Linen

Staff handling soiled linens should be appropriately trained and supervised regularly. Each healthcare facility should determine the best way to handle process and store linens.

Key steps in the proper handling, processing and storage of linens include:

- Housekeeping and laundry personnel should wear utility gloves and other personal protective equipment as indicated when collecting, handling, transportation, sorting and washing soiled linen
- Consider all cloth items (e.g., surgical drapes, gowns, wrappers) used during a procedure to be infectious
- Transport soiled and clean linens separately. If possible label them in separate containers; if only one container is available then transport the dirty ones first, and transport the clean ones last.
- Even if there is no visible contamination to linens they must be laundered
- Carry soiled linen in covered containers or plastic bags to prevent spills and splashes
- Keep the soiled linen in designated areas (interim storage area) until transported to the laundry
- Carefully sort all linen in the laundry area before washing
- **Do not pre-sort or wash linen at the patient care areas**
- When hand washing soiled linen:
  - ◆ Use warm water if available.
  - ◆ Add bleach (e.g., 30-60 ml, about 2-3 tablespoons, of a 5% chlorine solution) for ten minutes to aid cleaning and bactericidal action.
  - ◆ Add soap (a mild acid agent) to prevent yellowing of linen, if desirable.
- Patient's soiled personal linen should be decontaminated before handling back to the patient/relatives
- The patient should be informed about decontamination of their clothing if it is necessary.

Clean linen must be wrapped or covered during transport to avoid contamination



## Formulae for preparing chlorine

**IP Practices-1:** Formula for making 0.5% chlorine solution from powder bleach

If using bleach powder instead of liquid bleach, calculate the ratio of bleach to water using the following formula:

Example: To make 0.5% chlorine solution from calcium hypochlorite powder containing 35% available chlorine:

$$[0.5/35] \times 1000 = 0.0143 \times 1000 = 14.3$$

Therefore you must dissolve 14.3 grams calcium hypochlorite powder in one litre of water in order to get a 0.5% chlorine solution.

Note: Chlorine is highly corrosive therefore do not leave instruments in chlorine solution for more than the recommended time

**IP Practices-2:** Formula for making 0.5% chlorine solution from liquid bleach

Chlorine is bleach which comes in different concentrations. You can use any concentration to make a 0.5% (standard measure) chlorine solution by using the following formula:

$$\left\{ \frac{\% \text{ chlorine in liquid bleach}}{0.5\%} - 1 \right\} = \text{total parts of water for each part bleach}^*$$

Example: To make a 0.5% chlorine solution from a 3.5% chlorine concentrate, you must use one part chlorine and six parts water

$$\left[ \frac{3.5\%}{0.5\%} \right] - 1 = [7] - 1 = 6 \text{ parts of water for each part of chlorine (1:6)}$$

*\* Parts can be used for any unit of measure (for example, cup, litre or gallon) and need to represent a defined unit of measure (for example, pitcher or container)*

## Procedures for decontamination

Wear protective gloves. (Keep a separate set of gloves, preferably utility gloves, for decontamination.)

Submerge items in chlorine bleach solution for 10 minutes. **Do not submerge metal for more than 10 minutes.**

Remove the item(s), rinse immediately with cool water to prevent corrosion, and clean in routine manner.

## Cleaning

Cleaning instruments is necessary before high-level disinfection or sterilization to remove all visible foreign material and some microorganisms. Cleaning physically removes all visible dust, dirt, blood, or other bloody fluids from objects. It consists of thoroughly washing with soap or detergent and water using a brush and then rinsing with clean water and drying. **Dried organic materials can entrap microorganisms in a residue that shields them against sterilization or chemical disinfection.** Cleaning also reduces the load of bacteria. Supplies needed for

cleaning are: detergents or soap (use hand soap (e.g. bar soap) or powdered soap should be avoided because the fatty acids contained in the soap will react with minerals of hard water leaving a residue or scum that is difficult to remove); brushes of various sizes and types; heavy duty gloves (preferably utility gloves); and basins or sinks for detergent solution and rinsing.

### **Procedures for cleaning**

1. Wear protective gloves.
2. Rinse the items in cool water, opening or disassembling them when possible.
3. Submerge them in a basin with detergent and water prepared according to the manufacturer's directions. Make suds as you would for dishes.
4. Use brushes (a tooth brush works well) to remove soil and organic matter, paying attention to interior and hinged areas.
5. Rinse thoroughly in clean water.
6. Dry by air or clean towels before further processing.
7. Maintain cleaning supplies and equipment in dry, clean condition.

### **High-level disinfection (HLD):**

HLD is a process that eliminates most or many disease-producing microorganisms (including viruses which cause hepatitis B or AIDS), except some bacterial endo-spores from inanimate objects, by boiling, steaming, or the use of chemical disinfectants. (Boiling and Chemical disinfections are common methods and are explained below)

#### ***HLD by Boiling***

High-level disinfection by boiling is easy to do and relatively safe and inexpensive. Boiling will kill some endospores but not all, but the level of disinfection is acceptable for IUDs, IUD inserters, specula, tenacula, forceps, scissors, uterine sounds and IUD removal hooks. Any large covered cooking container and heat source can be used, although commercial boilers may be more convenient. Refer to *Steps in Processing Instruments and Equipment* (below) to determine which process to choose for specific instruments and pieces of equipment.

### **Procedures for Boiling**

1. Decontaminate and clean the items thoroughly. Disassemble equipment items when appropriate.
2. Place the cleaned items in the boiler and completely cover them with clean water. Consider boiling the same kinds of items together for easier handling.
3. Boil for 20 minutes. **Begin timing when boiling action starts.**
4. If an additional item is put in after boiling has begun, start timing again.
5. Remove items from boiler and put in covered, high-level disinfected or sterile containers using dry sterile or HLD handling forceps.
6. Never let boiled items remain in water once it has cooled. Microorganisms can begin to grow in the cool water, and it is possible that instruments will start to rust in the water after this length of time.
7. Store for up to one week in a high-level disinfected, covered container if dry.

#### ***HLD Using Chemicals***

Chemical disinfection can also be used in certain situations, such as when the item to be high-level disinfected cannot withstand heat. When doing chemical HLD, soak the items in a high-level disinfectant for 20 minutes and then rinse well in boiled water. A variety of chemical disinfectants are available. These are listed in the chart *Preparing and Using Chemical Disinfectants*.

## Procedures for Chemical High-Level Disinfection

1. Decontaminate and clean all instruments. Dry them so that water on the instruments does not dilute the disinfectant solution.
2. Cover all items completely with the correct dilution of disinfectant.
3. Soak for 20 minutes.
4. Remove the items with high-level disinfected or sterile large handling or pickup forceps.
5. Rinse well with boiled water and allow to air dry.
6. Store for up to one week in a HLD covered container or use immediately.

**Note:** *To prepare an HLD container, fill with 0.5% chlorine solution, soak for 20 minutes and rinse the inside with boiled water or boil the container. Allow it to air dry before use.*

## Sterilization

**The sterilization process ensures that all microorganisms, including bacterial endospores, are destroyed.** Decontamination through cleaning, rinsing and drying must precede sterilization of instruments and other items that come into direct contact with the bloodstream or tissues under the skin. Heat and chemical sterilization are the two types of sterilization usually available in hospitals. These methods is preferred methods for all instruments and should be used on items made of material that can withstand these processes. (Refer manufacturer instructions for any sterilizer)

## Heat Sterilization

An autoclave is necessary for heat sterilization.

## Procedures for Operating an Autoclave or Pressure Cooker

1. Decontaminate, clean and dry the instruments to be sterilized.
2. Disassemble the items as much as possible for best steam penetration.
3. Wrap needles and sharp edges in gauze to prevent dulling them.
4. Strictly follow the directions supplied by the manufacturer for operation of the autoclave

### If using autoclave, follow these instructions:

1. Loosely wrap instruments in a double layer of muslin or newsprint to allow steam to penetrate. **Don't tie the instruments tightly together with rubber bands or by other means.**
2. Arrange the packs so air can circulate and steam can penetrate all surfaces.
3. Heat water until steam escapes from the pressure valve only, and then turn down the heat enough to keep steam coming out of the pressure valve only. Don't allow it to boil dry. The temperature should be at 121°C (250°F); the pressure should be at 106 kPa or 15 lbs/in<sup>2</sup>; sterilize wrapped objects for 30 min. or unwrapped objects for 20 min.
4. After turning off the heat source, wait 20 - 30 minutes until the pressure gauge reads zero.
5. Open the lid and let the packs dry completely (about 30 minutes) before removing. (Damp packs act like a wick to draw in bacteria, viruses and fungi.)

Under optimal storage conditions and with minimal handling, properly wrapped items can be considered sterile as long as they remain intact and dry. For optimal storage, place sterile packs in closed cabinets in areas that are not heavily trafficked, have moderate temperature, and are dry or of low humidity. When in doubt about the sterility of a pack, consider it contaminated and resterilize the items. Use unwrapped items immediately after removal from the autoclave or keep them in a covered, dry, sterile container for up to one week.

## Note: These Chemicals are available in Tanzania

Disinfectant (Common Solution or Brand)	Effective Concentration	How to Dilute	Skin Irritant	Eye Irritant	Respiratory Irritant	Corrosive	Leaves Residue	Time Needed for HLD	Time Needed for Sterilization	Activated Shelf Life
Chlorine	0.5%	Dilution procedures vary	Yes (with prolonged contact)	Yes	Yes	Yes	Yes	20 minutes	Do not use	Change daily; sooner if cloudy
Glutaraldehyde: Cidex®	Varies	varies: read instructions on container	Yes	Yes; vapour	Yes	No	Yes	20 mins. at or above 25oC	10 hours for Cidex	Change every 14 days; sooner if cloudy
Hydrogen Peroxide (30%)	6%	1 part 30% solution to 4 parts boiled water	Yes	Yes	No	Yes	No	20 minutes	Do not use	Change daily; sooner if cloudy

## Safe handling of sharps during procedures

**Sharps:** any instrument capable of puncturing the skin (scissors, needles, scalpels or blades, etc.).

- In healthcare settings, injuries can occur easily from sharp instruments, especially during surgical procedures.

A **Safe Injection** is one that serves the intended purpose and

- Does not harm the client,
- Does not expose the provider to any avoidable risk, and
- Does not result in any waste material that is dangerous to the community.

## Principles of injection safety

- Injection should be administered by qualified personnel (e.g. a nurse)
- Use each needle and syringe once.
- Hands should be washed before and after administering an injection
- Always keep fingers behind the needle.
- Do not disassemble the needle and syringe after use.
- Sharps should be disposed of immediately after use
- Needles should not be recapped
- Safety boxes should be used properly.

## Nine “Rights” of safe injection

The **right** drug is given with the **right** formulation to the **right** patient in the **right** dose using the **right** needle and syringe at the **right** site by the **right** route at the **right** time and using the **right** method of disposal.

## Safe Injection Practices

Use each needle and syringe once.

Skin preparation for injections:

- Use a clean, single-use swab and maintain product-recommended contact time.
- Do not use cotton balls stored wet in multi-use containers.
- Clients receiving injections regularly (e.g., using Depo-Provera® for contraception) should be taught to wash the injection site (arm or buttock) with soap and clean water just prior to coming to the clinic or receiving the injection at their home.

Dispose of the needle and syringe in a puncture-resistant container placed within arm’s reach at point of use.

Precautions to take while handling injection equipment:

- Always keep fingers behind the needle.
- Do not disassemble the needle and syringe after use.
- If you must recap a needle do so using the ‘one-hand’ technique

**Do not recap, bend or break needles prior to disposal.**

**Remember: Always keep fingers behind the needle.**

### **Instructions for Hands-Free Technique**

The “hands-free” technique for passing sharp surgical instruments should always be used.

The assistant puts the sharps in a “safe zone” using a designated part of the instrument stand or area on the field where instruments can be placed.

The assistant tells the service provider that the sharps are in the safe zone.

The provider picks up a sharp item, uses it, and returns it to the safe zone.

### **Disposal of Sharps**

The principle of sharps disposal is to prevent potential harm and transmission of disease from injury with a contaminated sharp object.

Always dispose of sharps in a puncture-resistant container.

Do not handle sharps carelessly—they should be disposed of directly, without manipulation (e.g., do not recap, remove or bend needles).

Dispose of sharps immediately after use at the point of use.

Ensure that sharps containers are readily available and conveniently located so that HPs do not have to carry sharp items any distance before disposal (preferably within arm’s reach).

Sharps containers should be easy to see, recognize and use. Mark them clearly so that people will not unknowingly use them for disposing of garbage or discarding cigarettes.

Don’t shake a container to settle its contents and make room for more sharps.

Don’t place containers in high traffic areas (outside patient rooms or procedure rooms).

Use only a puncture-resistant, disposable sharps container.

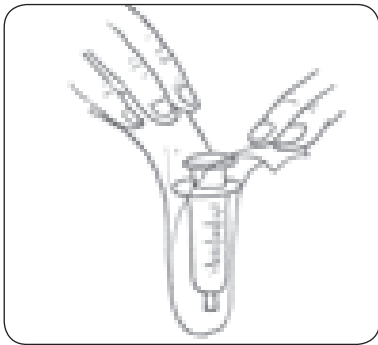
Dispose of the sharps container as a whole unit (incinerate, bury or encapsulate).

Manufactured sharps containers are available in some healthcare settings and are the best solution for safe sharps disposal. A puncture-resistant container can be made from a readily available object such as a heavy cardboard box with an opening small enough to prevent someone from trying to remove the discarded sharp objects or an empty jug from bleach or antiseptic

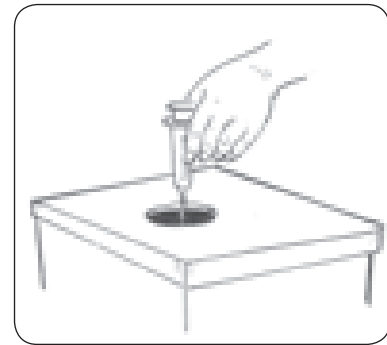


### Safe use of sharps containers (safety boxes)

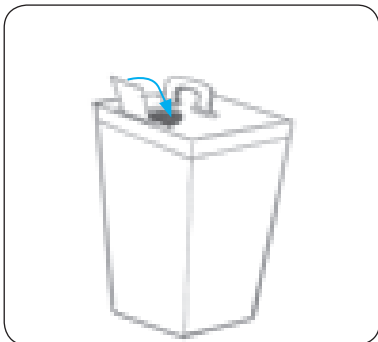
- All sharp containers must be clearly marked “SHARPS” and/or have pictorial instructions for the use and disposal of the containers
- Place sharp containers away from high-traffic areas
- Place all sharps containers within arm’s reach during the procedure
- Do not place containers near light switches, overhead fans, or thermostat controls where people might accidentally put their hands on them
- Never reuse or recycle sharps containers for other purposes
- Dispose safety boxes when  $\frac{3}{4}$  full
- Ensure that no sharp items are sticking out of containers
- Finally, dispose sharps containers by incineration or into sharp pits.



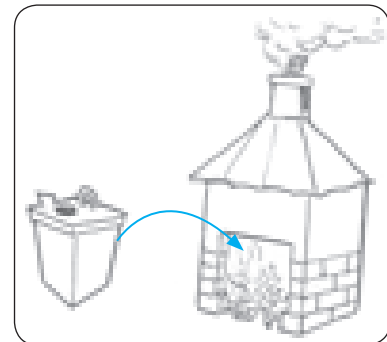
1. Open new, undamaged pack of syringe



2. Dispose used needle and syringe immediately



3. Close safety box when it is  $\frac{3}{4}$  full



4. Destroy it in the incinerator

### Safe disposal other infectious waste

#### Proper waste management involves the following steps:

1. Segregation
2. Handling and Storage
3. Transport
4. Treatment or Destruction
5. Final disposal

## Segregation

Segregation refers to separation of waste by type at the point and time of generation. Different types of waste should be placed in containers that are color-coded. If color-coded containers are not available, the containers should be well labeled.

### Recommended color codes for segregation of healthcare waste

Color of the container	Type of waste
Yellow	<b>Safety box (puncture-resistant) for the following sharps:</b> Needles and syringes, blades, broken glass, lancets, scissors, broken ampoules, slides and slide covers, etc.
Red	<b>Wet, infectious materials:</b> Blood, body tissues (amputations), body fluids (discharges), specimen (stool, sputum), placentas, wet dressings, catheters, blood infusion bags), etc.
Blue/Black	<b>Non-infectious materials:</b> Office papers, pharmaceutical packaging, plastic bottles, food remains, waste paper, trash, etc.

### Disposing of other waste material:

1. Wear utility gloves.
2. Empty waste containers everyday.
3. Either incinerate or throw in a deep pit, burn and bury when  $\frac{3}{4}$  full.
4. Pour liquid waste in a sink, toilet or latrine or pour in a deep pit along with dirty waste.
5. Clean the sink, toilet or latrine and drain/flush with water to remove residual waste.
6. Decontaminate the waste container by filling with chlorine - 0.5% solution for 10 minutes before washing.
7. Decontaminate and wash utility gloves.
8. Wash hands with soap.

#### Note:

All health workers, working in the health facility should segregate waste at the point and time of generation. This is important in order to achieve proper waste disposal of infectious waste and protect other staff in the same workplace and the community nearby the workplace.

## Occupational exposure and post-exposure prophylaxis

### Introduction

If a health provider is exposed to blood or other body fluids, either by a needle stick/sharps injury or a splash to a mucous membrane, conjunctiva or non-intact skin, the person should be offered PEP. PEP is the management of this exposure.

### Definition

**Post-exposure prophylaxis (PEP)** is the immediate provision of medication following an exposure to potentially infected blood or other body fluids in order to minimize the risk of acquiring infection.

## Occupational Exposure:

### The Risk of Transmission of HIV, HBV and HCV

The risk of transmission through percutaneous (needle stick) exposures from:

- HIV-positive patients is estimated at 0.3%
- Hepatitis B (HBV)-positive patients is estimated at 30–40%
- Hepatitis C (HCV)-positive is estimated at 0–10% (average 1.8%)

### Body fluids known, presumed and not known to be infectious

Body fluids <b>known</b> to be infectious	Body fluids <b>presumed</b> to be infectious	Body fluids <b>NOT known</b> to be infectious (if not visibly bloody)
Blood	Cerebral spinal fluid	Tears
Any fluid with blood	Pleural fluid	Saliva
Semen	Pericardial fluid	Urine
Vaginal secretions	Peritoneal fluid	Feces
Breast milk	Amniotic fluid	Sweat
	Synovial fluid	Vomit

#### Note:

Consider any body fluid as infectious unless proven otherwise. The risk of transmission increases with larger volumes of fluid and more severe injuries.

### Common Procedures Which Present a Risk of Exposure

The most common procedures presenting a risk of exposure to blood and other body fluids include the following:

1. Taking blood samples from arteries or veins and samples of other body fluids
2. Inserting an IV line and handling drips especially in emergency situations
3. Activities related to surgery, particularly during major surgical interventions for long duration or where haemorrhage may occur
4. The handling of blood or infectious body fluids by laboratory staff
5. Activities related to handling, pre-disinfection/cleaning of contaminated medical devices
6. Handling and disposal of infectious waste
7. Providing injections/intravenous medication

### Roles of HP responsible for PEP

The Health Provider responsible for PEP should assess the type and time of exposure, first aid measures taken and risk of HIV, HBV and HCV transmission following accidental exposure.

### Steps to Follow Once a HP is Exposed to Blood and Other Body Fluids

#### **PEP Step 1: Treatment of Exposure Site**

- Wash with soap and water as soon as possible.
- Flush mucous membranes with clean water.

- Flush exposed eyes with a litre of clean water or normal saline solution.
- Get a tetanus immunization or booster, if indicated, for a needle stick (e.g., > 10 years since immunization).

**Remember:**

The application of caustic agents (e.g., bleach) or disinfectants to the exposure site is not recommended and may do more harm than good. There is no evidence that squeezing a puncture site helps prevent infection or that the use of antiseptics is better than soap.

**PEP Step 2: Report and Document**

- The accident should be reported to a senior work supervisor immediately.
- An injury report form should be filled out as soon as possible.

**PEP Step 3: Evaluate the Exposure**

- HPs should be evaluated within 2 hours (rather than days) after their exposure and started on prophylaxis, if indicated, and not later than 72 hours after exposure.
- If determined to be exposed to HIV, they should be counselled and tested for HIV; baseline testing and further follow-up of the exposed person is necessary.
- Baseline testing of the exposed HP should include the following tests: Full blood count, liver function tests, renal function tests and pregnancy testing for female HP if the status is not known

**PEP Step 4: Evaluate the Exposure Source**

- This should be started immediately after the HP has agreed to start PEP.
- Do not test discarded needles or syringes for viral contamination.
- If the source person is not known, treat the exposure as though at high risk for infection.

**PEP Step 5: Provision of Anti-Retroviral (ARVs) Drugs for PEP**

- PEP should be initiated as soon as possible, preferably within two (2) hours. PEP is not indicated for exposures that occurred more than seventy two (72) hours previously.

S/N	Source person	Healthcare worker	Healthcare worker management
1	HIV positive	HIV negative	<ul style="list-style-type: none"> <li>• PEP for 28 days then monitoring for six months</li> </ul>
2	HIV positive	HIV positive	<ul style="list-style-type: none"> <li>• Stop PEP</li> <li>• Refer to CTC</li> </ul>
3	Refuses to be tested -assume positive	HIV negative	<ul style="list-style-type: none"> <li>• PEP for 28 days then monitoring for six months</li> </ul>
4	HIV negative	HIV negative	<ul style="list-style-type: none"> <li>• No PEP</li> </ul>

Source: CDC Guidelines (2001)

**Note:**

Refer to current NACP/MOHSW–National HIV/AIDS Care and Treatment Guidelines for more details and updates on ARV regimen for PEP, dosage, side effects and their management.

## **PEP Step 6: Follow-Up of HPs exposed to HIV**

Follow-up is based on clinical examination and laboratory testing to determine the sero-conversion and adverse effects of the ARV drugs.

- HIV antibody test must be performed for at least 6 months post-exposure (i.e., at 6 weeks, 12 weeks and 6 months).
- Exposed person must be re-evaluated within 72 hours, as additional information about the source is obtained including serologic status, viral load, current treatment, any resistance test results or information about factors that would modify recommendations.
- If PEP is administered, the exposed person must be monitored for drug toxicity by testing at baseline and 2 weeks after starting PEP.
- Basically, the testing will include a full blood picture (FBP), renal (RFT) and hepatic function tests (LFTs). PEP should be continued for 4 – weeks if tolerated. If PEP fails and the exposed person becomes HIV infected, he/she must be referred to HIV care and treatment clinic (CTC) for expert care and management.

### **Remember:**

#### **HIV—PEP should be:**

- Initiated as soon as possible (within 2 hours)
- Administered for 4 weeks
- Discontinued if the source person is determined to be HIV-negative or the exposed person is HIV-positive

#### **HBV—**

- If HBV-susceptible, get hepatitis B immunoglobulin (HBIG) 5mL IM (intramuscularly) within 7 days of exposure, and also give the first dose of HBV vaccine, which should be repeated at 1 and 6 months.

#### **HCV—**

- There is no post-exposure vaccine or drug prophylaxis for hepatitis C (immunoglobulin is ineffective). Prevention of exposure, therefore, is the only effective strategy for prevention of HCV.



## **CHAPTER 3:**

# **Educating and Counseling Clients for Family Planning and other RH Services**

### **Overview**

This chapter presents information and procedures on Educating and Counselling clients to make decisions about use of FP and other RH services. Both are performed by a skilled service provider but are used in different situations and require different approaches.

Educating clients and communities is important to raise awareness about FP and other RH issues so families and individuals can make educated decisions about using FP, spacing their children, preventing infectious diseases and seeking treatment and other services in a timely manner.

Counselling is essential in helping clients to make informed voluntary choice about the use of the family planning methods that best suits their needs. It also helps clients to make decisions about disease prevention, HIV testing and healthy timing and spacing of pregnancy, proper antenatal care and other RH issues.

## A. Educating Clients on Family Planning

- **Education** is the process of transferring knowledge about specific issue or topic area that is general and not tailored to any individual needs. It is often done in group settings
- **Information, Education and Communication (IEC) materials** are used in the process of informing, educating and communicating issues to individual and groups including men, women, adolescents, community members and the population at large for the purpose of changing their behaviour and attitude.

These materials include brochures, pamphlets, posters, cue cards, videos, billboards, radio announcements and others.

### Purposes for conducting FP/RCH client education

- Creates awareness about FP and other RCH services among different target groups
- Promotes behavioural change for FP/RCH services
- Encourages people utilise FP/RCH services
- Creates demand for FP/RCH services
- Inform people on their reproductive health rights
- Assists people to make voluntary informed FP/RCH decisions
- Dispels rumours and misconceptions regarding FP/RCH services
- Strengthens client/provider/community relationship
- Updates people on new FP/RCH services and issues

### Target groups for FP and other RCH educational session

All men and women in the reproductive age group are targets for FP/RCH education; however the following groups are a high priority because of the effects of pregnancy, childbirth and poor reproductive and child health practices on their families:

Women groups, women and men with infertility problems, breastfeeding mothers before six months after delivery, antenatal mothers in preparation for breastfeeding or voluntary surgical contraception soon after delivery, newly delivered mothers, women who have had miscarriages/abortions, mothers who had five or more pregnancies (too many), women who are over thirty five (too late), youth groups in the community, women below twenty (20) years of age (too early), women with bad medical /obstetrical history, individual men and women, couples and adolescents with STI/HIV infection and/or AIDS, parents/guardians with malnourished children, school children, out of school children, parents/guardians with children who are under five years, pregnant women, women, adolescents despite having no direct physical effect, displaced communities, persons with disabilities etc.



## **Proposed topics/messages from which to develop important content for health education**

- Benefits of exclusive breastfeeding
- Myths and misconceptions about breastfeeding
- Family Planning Health and Social benefits for mother , baby, father and family
- Modern FP methods
- Nutrition of mothers and under five year old children
- Early detection and management of childhood illnesses
- Responsibilities of men, women and adolescents in reproductive and child health
- STI/HIV/AIDS
- Risk of pregnancy in persons with HIV/AIDS
- Risk of pregnancy in women below 20 years of age
- Risk pregnancies in women 35 years of age and over
- Risk of pregnancies and birth intervals of less than 2 years
- Risk of pregnancies for women who have had 5 or more pregnancies
- Every pregnancy is a risk
- Emergency contraception
- Gender issues in reproductive health
- Adolescent/youth reproductive health services
- Infertility
- Dangers of induced abortion
- Facts on adolescents/youths sexuality
- Factors which influence adolescents/youth FP/RCH behavior

## **Advance Preparation for educating clients**

### **I. Prepare visual aids based on the topic of your session and availability of materials. These visual aids may include:**

Different types of contraceptives

- Models such as pelvic and penis model
- Posters, brochures and pamphlets
- Flipcharts/Flipbooks
- Education session plan/outline

### **II. Develop a plan for FP/RCH Education Session**

A well organized and written plan for FP/RCH education session is important because it:-

- Helps the provider to be consistent, systematic and to keep to the topic.
- Can be used for future similar topics.
- Helps solicit inputs from colleagues or literature.

The provider should use the following guiding questions for the provider when planning a FP/RCH education session:

## Guiding questions for the provider when planning a FP/RCH education session

	GUIDING QUESTIONS	WHAT IT MEANS
1.	Why do I want to give the talk? What problem(s) am I trying to solve through talking with the group?	Purpose/Objectives
2.	Whom will I talk to?	Target Group
3.	What will I talk about to achieve the purpose?	Topic
4.	What do I want the group to know or do by the end of the talk?	Objectives
5.	What are the major points	Major Points
6.	How will I deliver the content to make sure the group is involved and does not get bored?	Participatory Methods
7.	What IEC materials do I need to make the group understand and keep them interested e.g. IUCD, posters, pelvic models, packets of COC and POP, Implants etc.	Audio-Visual Aids
8.	How will I know the group has understood and the purpose has been met?	Questions and Answers
	Or	
	How will I know the objectives have been met?	
9.	How will I conclude the session?	Summary and Closure

## B. Written Sample of a Plan for FP/RCH Education Session

**Topic:** Family Planning Methods suitable for Post Partum Mothers

**Target Group:** Newly Delivered Mothers in Maternity Ward

**Purpose:** Create demand of FP/RCH services

Time Allotment	Objective(s)	Content / Major Points	Education Process	Teaching Aids / References	Evaluation Method(s)
		Introduction	<ul style="list-style-type: none"> <li>- Greetings</li> <li>- Introduce self and other colleagues</li> <li>- Ask audience if well seated and comfortable</li> <li>- Ask if any audience has a special problem</li> <li>- Assist accordingly</li> </ul>		
	<p><b>The newly delivered mothers will be able to:</b></p> <ul style="list-style-type: none"> <li>- Identify dangers of pregnancies that occur less than 2 years apart</li> </ul>	<p><b>Danger to the Mother</b></p> <p><b>Danger to Baby:</b> Premature babies</p>	<ul style="list-style-type: none"> <li>- Ask questions related to the topic</li> <li>- Acknowledge responses</li> <li>- Introduce topic and objectives</li> <li>- Present topic factually</li> <li>- Use visual aids as required</li> <li>- Ask questions and allow questions</li> <li>- Clarify concerns as necessary</li> </ul>	IEC materials related to the topic	Questions and answers

Time Allotment	Objective(s)	Content / Major Points	Education Process	Teaching Aids / References	Evaluation Method(s)
	State the FP methods that postpartum women can use	FP methods <ul style="list-style-type: none"> <li>- LAM</li> <li>- Pills</li> <li>- Injectable</li> <li>- IUCD</li> <li>- Implants</li> <li>- Condoms (female &amp; male)</li> <li>- BTL - Vasectomy (men)</li> <li>- Natural Methods</li> </ul>	<ul style="list-style-type: none"> <li>- Ask what FP methods are suitable for post partum women?</li> <li>- Acknowledge their responses and clarify as necessary</li> <li>- Show each method and explain how it is used</li> <li>- Use IEC materials to explain</li> <li>- Allow questions and respond factually</li> </ul>	<ul style="list-style-type: none"> <li>- Samples of FP methods</li> <li>- IEC materials</li> </ul>	
	State when and where to get the FP methods	<b>When to start and where to get FP method</b> <ul style="list-style-type: none"> <li>- Public and private health facilities</li> <li>- CBDAs</li> <li>- Pharmacies</li> </ul> <b>Where to get the FP methods</b> <ul style="list-style-type: none"> <li>- Public and private health facilities</li> <li>- CBDAs</li> <li>- Pharmacies</li> </ul>	<ul style="list-style-type: none"> <li>- Explain when the methods can be started</li> <li>- Ask the group where they can get FP methods</li> <li>- Acknowledge responses and add to what they know</li> <li>- Pause to allow questions and answers factually</li> </ul>		Questions and answers  Questions and answers
		Evaluate and close the session <ul style="list-style-type: none"> <li>- Offer IEC materials</li> <li>- Thank them for their participation and close the session</li> <li>- Direct them to the services they came for.</li> </ul>	<ul style="list-style-type: none"> <li>- Ask the group what they feel about the session</li> <li>- Ask what they have learnt</li> <li>- Ask what they will do as a result of what they have heard and seen</li> <li>- Summarize major points</li> </ul>		Questions and answers

### **III. Conducting Individual, Group and Community FP Education**

#### **A. Prepare for education session**

- Review the messages related to the topic
- Prepare written notes with the session topic, objectives, main content, participatory process and evaluation method(s)
- Assemble and arrange IEC materials in sequence of presentation
- Arrange the seating for the clients
- Position self for presentation

#### **B. Establishing Rapport**

- Welcome and greet the clients/group in the culturally accepted manner
- Introduce self and colleagues
- Check if the group is comfortably seated

#### **C. Conducting the session**

- Introduce the topic and explain session objectives and duration of the session
- Ask the group what they know about the topic
- Allow the participants to respond
- Commend the group for positive information they know about the topic
- Present the information/messages using simple non-technical language building on what the group said in their response
- Use visual aids or local sayings appropriately
- Pause and allow questions and also ask the group questions to determine if there is a general understanding of the information discussed.
- Answer the questions factually, and when unable to answer a question inform the group accordingly

#### **D. Evaluating the session**

- Ask the group what they have learned from the session and how they plan to use the information
- Paraphrase what the group has learned and how they plan to use the information
- Re-state the session objectives and check with the audience the extent to which they have been met.

#### **E. Close the session**

- Summarize the major points of the session
- Distribute appropriate leaflets/booklets
- Thank the group members for their participation

## IV. Ways and when to evaluate FP/RCH education session

Ways to evaluate FP/RCH educational session

- Question and answers
- Observing non-verbal cues e.g. facial expression, body language and active participation
- Review of clinic records shows increase in client load

### When to evaluate FP/RCH education session

- Throughout the session
- Summative evaluation

## C. Counselling Clients on Family Planning

Counselling is the process where a trained provider helps client to make an informed voluntary decision to solve a problem with an understanding of the facts and emotions involved. This process is dynamic, interactive and allows clients to explore and express their needs, issues or problems.

Counseling is one of the critical elements in the provision of quality family planning services. Good counseling leads to improved client satisfaction. A satisfied client promotes family planning, returns when s/he needs to and continues to use a chosen method. Good family planning counseling procedures have two major elements and occur when:

1. Mutual trust is established between client and provider. The provider shows respect for the client and identifies and addresses her/his concerns, doubts, and fears regarding the use of contraceptive methods.
2. The client and service provider give and receive relevant, accurate, and complete information that enables the client to make a decision about family planning.

## Giving and receiving feedback during Counseling

### Definition

### Feedback

Feedback is a method of receiving or giving information about behaviour. It is a way of letting a person (the receiver of the feedback) know in a timely and descriptive manner how he/she is performing or how the receiver's behaviour affects the person who provides feedback (giver) and/or others.

### Purposes of giving and receiving feedback

- To help someone/receiver know about her/his performance e.g. skills acquisition.
- To inform someone on her/his behaviour and how it affects others.
- To enable the giver to express feelings, observation and give recommendation.
- To help receiver examines self and make plans to change or maintain good behaviour.

## Feedback skills

In order to provide effective feedback, it is important to master other counselling skills, such as effective questioning and good listening.

- Effective Questioning:
  - Open ended questions.
  - Closed ended questions.
  - Probing questions.
- Good listening skills.
  - Active listening.
- Reflection
- Summarising and Paraphrasing.
- Praise and encouragement.
- Giving information.
- Observing non-verbal cues.

## Rules for Giving Feedback

- Provide descriptive objective feedback (not judgemental).
- Use “what”, “how” rather than “why .....” use “I” rather than “you”.
- Be clear and straight to the point.
- Use specific statements supported with specific example.
- Prepare self to give the feedback (think before saying something).
- Provide both positive and negative feedback, as necessary

## Rules for Receiving Feedback

- Ask for timely feedback.
- Do not react angrily or defensively by explaining e.g. “I did it because ....”
- Use “what”, “how” and not “why”? Use “I” not “you”.
- Seek clarification by paraphrasing or by using open-ended questions.
- Thank the giver and say what you will do as a result of being given the feedback.
- If recording the giver’s views clarify by paraphrasing and write the statements as said without changing the meaning.

## Types of Family Planning Counseling

There are different types of family planning counselling, including:

- **Counselling for Informed Choice** is a process whereby an individual/couple is assisted to choose a preferred FP method after being provided with clear, accurate, complete and specific information tailored to client’s reproductive goals and needs. Informed choice also implies having a range of FP methods to choose from.
- **Method-specific Counseling** occurs after an informed choice is made on a preferred method. During this counseling session, more information on the method of choice is given, screening process and procedures explained, instructions about how and when to use method given, including what to do if there are problems discussed, and when to return for follow-up is discussed.

Method specific counseling is also conducted during return/follow-up visits and focuses on helping a continuing users and managing side effects, or complications.

Counseling can occur at individual level or in a group. Counseling has succeeded when

- Clients feel they got the help they wanted
- Clients know what to do and feel confident that they can do it
- Clients feel respected and appreciated
- Clients come back when they need to
- Clients use their methods effectively and with satisfaction

## I. Conducting Counseling for Informed Choice of Family Planning Methods

In order to make a choice that is truly informed voluntary informed decision, the client needs to know:

1. What the method is.
2. How it works to prevent pregnancy.
3. Effectiveness
4. Advantages including non contraceptive benefits.
5. Disadvantages/side effects.
6. Who can use.
7. Who cannot use.
8. Whether prevents STI/HIV/Dual Protection

When conveying information to the client, the provider should consider the following **RESPECT** principles during the counseling process, as follows:

### Rapport

The provider should try and understand the client's point of view. The provider should be friendly and respectful, not judging, arguing or scolding the client or make assumptions about her/him. The provider must assure privacy and confidentiality

### Empathy

The provider should remember that the client has come for help and reasons for her behavior and ideas need to be understood. The provider must use positive body language and other strategies to demonstrate non judgmental acceptance or the client's ideas and feelings. The provider must verbally acknowledge the client's feelings and express understanding.

### Support

The provider asks about and acknowledges the barriers to care and compliance and offers the client concrete ways to overcome them. The provider involves family members when appropriate and reassures the client that she or he is there to help and answer questions. The client should be encouraged to return to the clinic if s/he has any concerns.



### **Partnership**

The provider must be flexible and acknowledge the client's needs. S/he should stress that the client and provider are working together and let the client know s/he has options and can make her own choices. The provider should make a plan for the client to continue to return to the clinic for follow-up and also help returning clients weigh options of continuing or switching methods.

### **Explanations**

The provider should give information about available methods. S/he should ask which method interests the client and what the client knows about the method. The provider corrects myths, rumors, and incorrect information. S/he uses audio-visual aids during counselling to describe how the method works and its effectiveness, the benefits and risks, potential side effects and warning signs.

The provider offers clear action steps to respond to side effects and warning signs. S/he explains clearly what the client has to do to use the method successfully and asks the client to repeat back instructions. The client is reminded again of danger signs and all her questions clearly answered. The client is encouraged to return with problems or concerns.

### **Cultural Sensitivity**

The provider respects the client's life style, cultural, and religious beliefs. S/he helps the client understand how these may influence family planning and other reproductive health choices. The provider understands that the client's view of the provider may be defined by ethnic or cultural stereotypes. The provider is aware of his or her own cultural biases and preconceptions and knows his or her own limitations in addressing counseling and medical issues across cultures. The provider can explore cultural influences on attitudes and beliefs without disapproval and can help the client explore these issues as well.

### **Trust**

The provider recognizes that it may be difficult for clients to share personal information. S/he is effective at gradually developing and consciously working towards establishing trust a trusting relationship. The provider responds to the client's concerns, including rumors, respectfully and constructively. S/he respects the client's choice of family planning methods.

## **Advance Preparation for Counselling clients**

### **Prepare visual aides required for FP counselling session such as:**

- Different types of contraceptives
- Models such as pelvic and penis model
- Posters, brochures and pamphlets
- Counselling flipcharts/flipbooks
- Pregnancy checklist
- Screening checklist

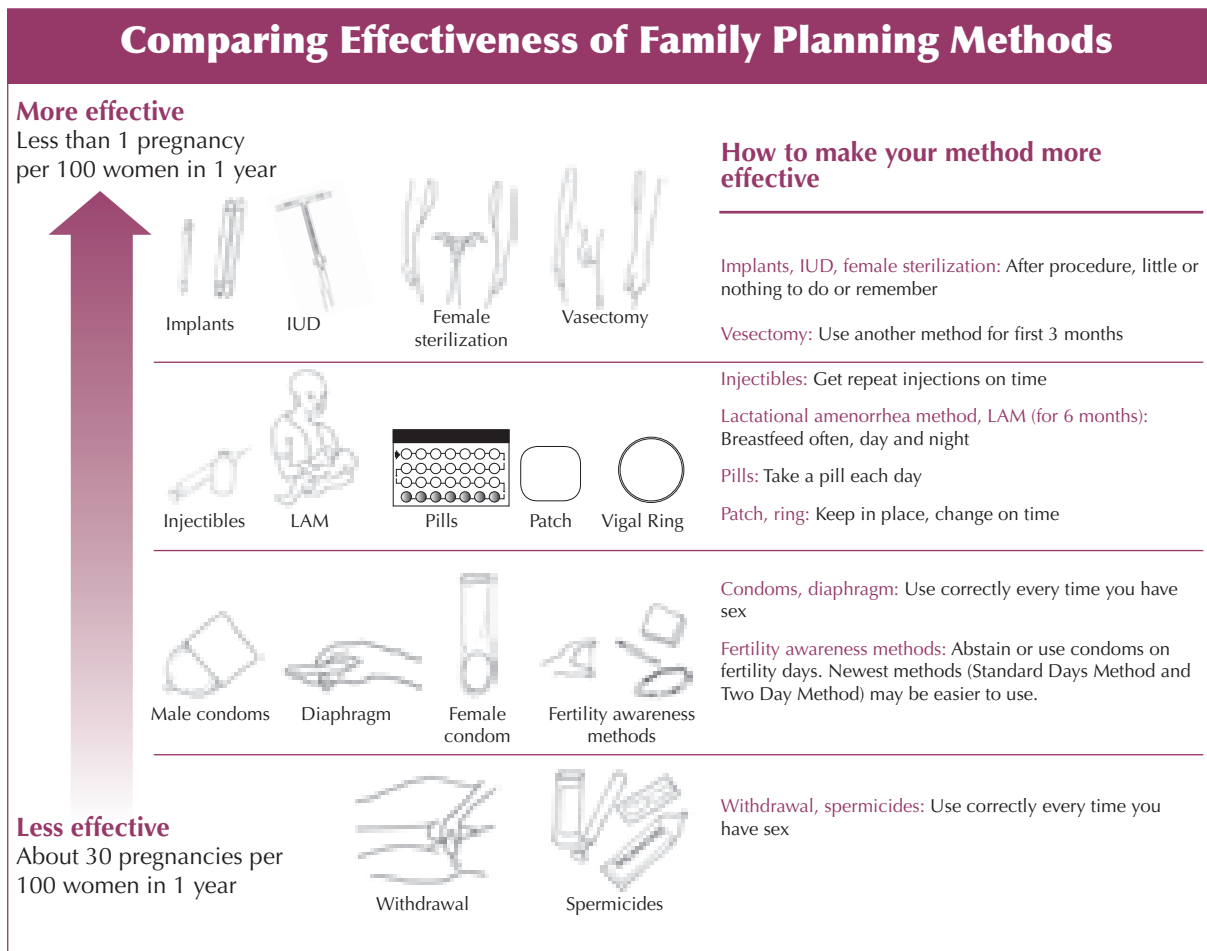
### **Prepare self and counseling room**

- Make sure there is privacy both auditory and visual
- Arrange furniture to ensure optimal interaction between the provider and the client

## Key Steps In Informed Choice Counseling

Providers should follow the steps below to counsel clients for informed choice of FP methods:

- **Establish and maintain positive provider/client interpersonal relationship**
  - Welcome, greet and make client comfortable
  - Determine the purpose of the visit and explore if the client may have any additional special needs. Group that may have special needs include: men, couples with infertility issues, youths, PLHIV, post partum mothers, post abortion women, premenopausal women.
  - Ask whether the client has come with the partner or close relative and whether she would like that person to be in the counseling room during session
  - Assure confidentiality of all the information discussed
  
- **Explore clients situation and reproductive goals and needs**
  - Ask client about her/his reproductive goals
  - Ask the client whether she has any other reproductive health concerns or problems
  - Ask the client what she/he knows or has heard about family planning methods
  - Ask client which family planning method she/he is interested and what she knows about this method
  
- **Explain family planning methods according to clients interest and goals and help to choose a method**
  - *If client does not know what FP method she/he wants to use*
    - Explain FP methods according to clients interest and goals
    - Help the client choose a method that meets her needs best. Consider asking the following questions to help make a choice:
      - (a) Do you wish to have children in the future?  
*For example, if the client answers NO to this questions, she/he may be interested to use a long acting method or a permanent method of contraception.*
      - (b) Are you breastfeeding an infant less than 6 months old?  
*If she is, it will rule out COCs for now as women who breastfeed should avoid methods containing estrogen until a baby is at least 6 months old*
      - (c) Does your partner support you in family planning?  
*If her partner does not support family planning, she may consider using method that is more private, for example an IUCD.*
      - (d) Are there any methods that you do not want to use or have not tolerated in the past?  
*If this is the case, provider can allocate more time to other FP methods and not to ones client didn't like or didn't tolerate in the past.*



**Understanding effectiveness of different contraceptive methods is essential in order for client to make informed contraceptive choice.** This chart, presents contraceptive methods on a continuum of effectiveness, from less effective to more effective.

## II. Special Counseling Needs for High Risk Clients

### Definition of a high risk client

High risk clients are those whose health/lives or health/lives of their child/children will be put at risk by pregnancy or other consequences of unprotected sex. This will consequently affect the child/children, partner and family.

### Purpose of counseling for high risk clients

- Creating awareness about the health risk/problem
- Promoting the understanding of the effect of health risk or/and problem on the mother, child and family.
- Identifies possible solutions to the problem such as need for family planning or need for relevant RCH services.

### Different groups of high risk clients

- Too early-women giving birth when their age are below 20 years of age.
- Too soon –women whose birth intervals are less than 2 years

- Too many-women who have had 4 or more pregnancies
- Too late-women becoming pregnant at 35 years of age and above
- Antenatal clients
- Postnatal clients
- Post abortion clients
- Women who are likely to have problems during pregnancy and childbirth
- Breast feeding mothers within 6 months after delivery
- Women with bad/complicated obstetric history (BOH)
- Gender based violence victims (rape, incest sexual abuse, physical or emotional violence.
- Breast feeding mothers within 6 months after delivery
- Women with chronic medical conditions e.g. Diabetic mellitus heart disease etc.

### **Steps in counseling clients to make voluntary decision(s) on FP**

- Establish and maintain client/provider relationship that will facilitate free flow of information
- Start to discuss the health risk factor/issue identified
- Provide information related to the problem
- Ensure client understands the information provided
- Help client to make an appropriate decision to solve the problem
- Close the discussion

### **Healthy Timing and Spacing of Pregnancies (HTSP)**

For women and couples who desire a next pregnancy after a live birth and postpartum women:

- For the health of the mother and the baby, wait at least 24 months after birth before trying to become pregnant again.
- Consider using a family planning method of your choice during that time.

For couples who decide to have a child after a miscarriage or abortion:

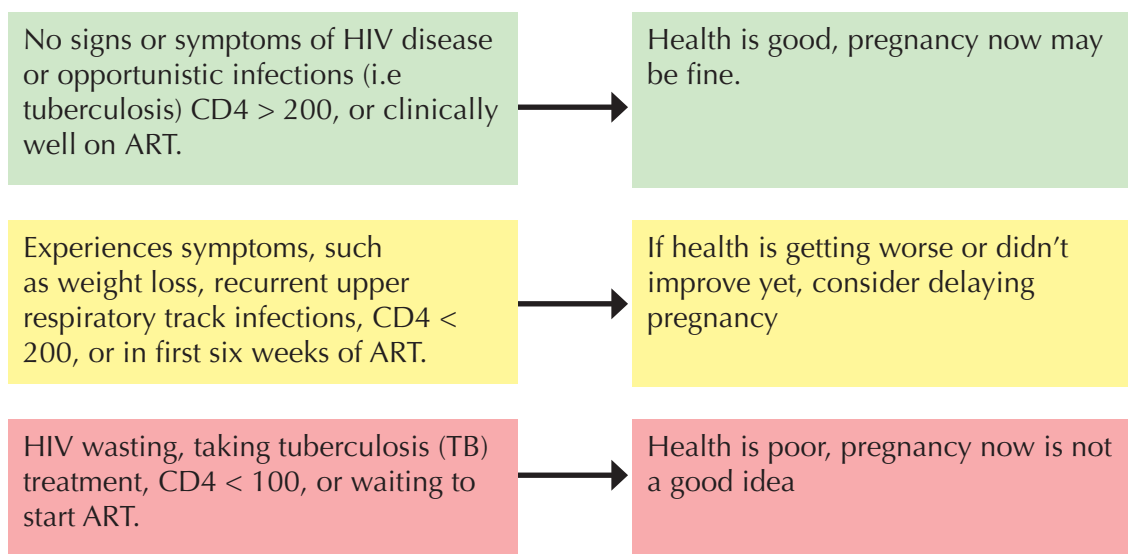
- For the health of the mother and the baby, wait at least six months before trying to become pregnant again.
- Consider using a family planning method of your choice during that time.

For adolescents:

- For your health and your baby's health, wait until you are at least 18 years of age, before trying to become pregnant.
- Consider using a family planning method of your choice until you are 18 years old.

For HIV-positive women and couples who desire a next pregnancy after a live birth:

- For the health of the mother and the baby, wait at least 24 months after birth before trying to become pregnant again.
- Consider using a family planning method of your choice during that time
- Risk of HIV transmission from mother to child always exist, but may be higher in women with new HIV infection or those who are not clinically well (have high viral load). These women should avoid pregnancy until their health improves.
- Encourage the client to consider the optimal time to become pregnant using the following algorithm:



## Post partum mothers

Provide counseling about the benefits of delaying the next pregnancy for two years

**When pregnancies are too close together** (less than 24 months from the last live birth to the next pregnancy):

- Newborns can be born too soon and/or with a low birth weight.
- Infants and children may not grow well and are more likely to die before the age of five.
- Less than six months from the last live birth to the next pregnancy:
- Mothers may die in childbirth.
- Newborns can be born too soon, too small, or with a low birth weight.
- Infants and children may not grow well and are more likely to die before the age of five.

## Post abortion women

Counsel women on the quick return of fertility after abortion (induced or spontaneous) and encourage the use of an effective FP method of their choice for at least six months before trying to become pregnant again.

- For the health of the mother and the baby, wait at least six months before trying to become pregnant again.
- Consider using a family planning method of your choice during that time.

## Men

Men have special counseling needs and should receive special attention from providers to motivate them to make responsible choices regarding reproductive health practices.

- Men need to be encouraged to support women's use of family planning methods or to use

family planning themselves (condoms or vasectomy).

- ◆ It is important to talk to YOUNG MEN (14-18) about responsible and safe sex before they become sexually active.
- ◆ Men often have less information or are more likely to be misinformed about family planning methods, male and female anatomy, and reproductive functions because they tend to talk less about these issues than women.
- ◆ Men are often more concerned about sexual performance and desire than women.
- ◆ Men often have serious misconceptions and concerns that family planning methods will negatively impact their sexual pleasure and/or performance.
- ◆ Men are often concerned that women will become promiscuous if they use family planning.
- ◆ Many men do not know how to use condoms correctly. Providers should always demonstrate correct condom use, using a model, when possible.
- ◆ Men are often not comfortable going to a health facility, especially if it serves women primarily. Providers should try to go to where men are to discuss family planning whenever possible (e.g., work places, bars, sporting events, etc.).

## Youth

- *For your health and your baby's health, wait until you are at least 18 years of age, before trying to become pregnant.*
- *Consider using a family planning method of your choice until you are 18 years old.*
- PLHIV

## Peri-menopausal women

*Monthly Bleeding does not come every month as menopause approaches, a woman is considered no longer fertile once she has gone 12 months in a row without having any bleeding.*

- To prevent pregnancy until it is clear that she is no longer fertile, an older woman can use any method, if she has no medical condition that limits its use.

## **CHAPTER 4:**

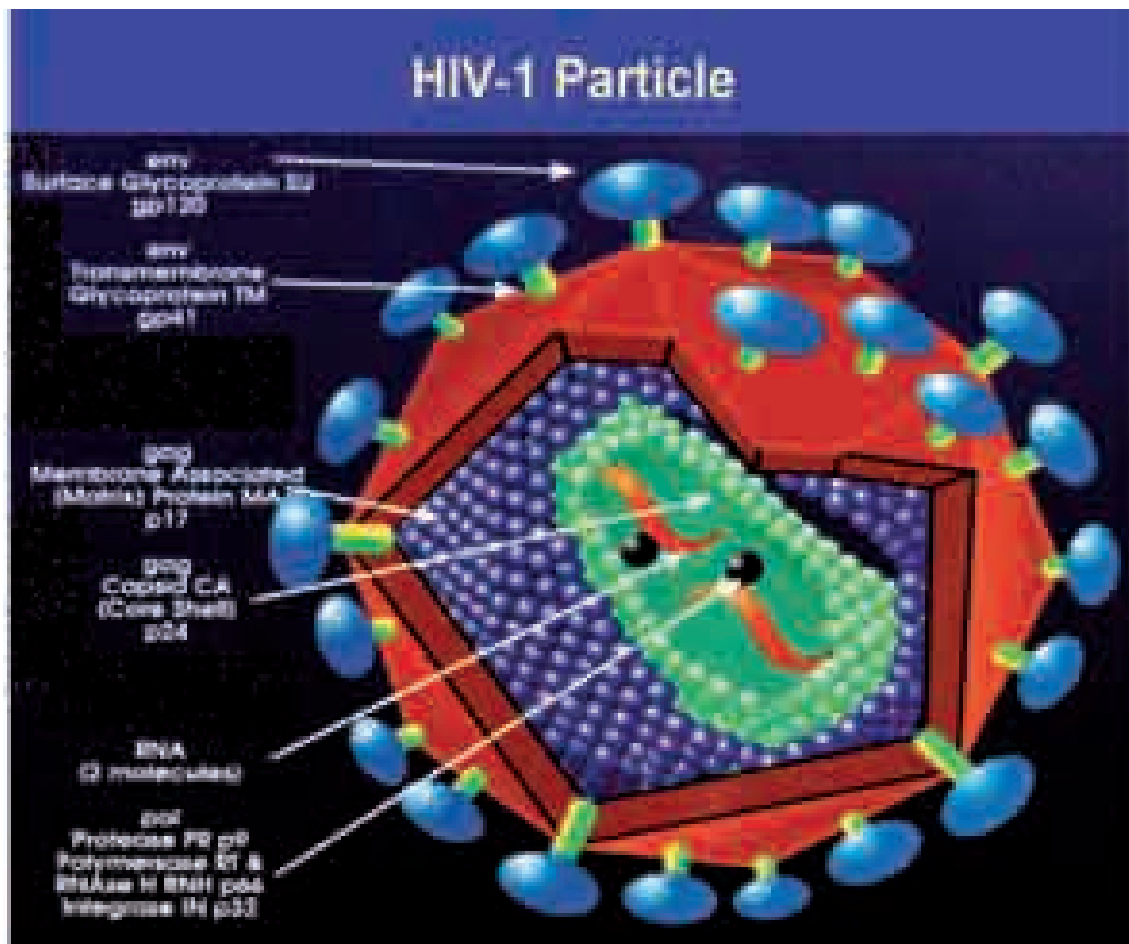
# **PROVIDER INITIATED TESTING AND COUNSELLING – PITC**

### **Overview**

The challenge Tanzania faces is that less than 15% of the population knows of their HIV status. Until recently HIV counseling and testing has been done in centers designated for Voluntary and Testing (VCT) located in the community health care facility. Clients have known their HIV status by choosing to seek counselling and testing services from VCT centres. The majority of these clients are HIV-negative, and therefore, post test counseling focuses on risk behaviours and risk reduction. In contrast, PITC is initiated by the service provider when an individual is seeking other health services. The service provider recommends, offers, and performs HIV testing and counseling as s/he provides the primary service, unless the client refuses (Opts out). In some clinical settings, a large proportion of clients tested through PITC are HIV-positive. Thus, post-test counseling focuses on preventing the spread of HIV and linkage to HIV care and treatment. Complimenting VCT with provider-initiated HIV testing and counseling (PITC) makes HIV testing and counseling more accessible and feasible than depending on VCT alone.

## THE BASICS OF HIV/AIDS

**HIV is the virus that causes AIDS.** Only visible with a very powerful microscope, HIV looks like a spherical particle of 80 to 100  $\mu\text{m}$  in diameter. Like all viruses, it is made up of 2 main elements: the external envelope, and the internal core. The envelope serves as an antigen, and a person's body makes antibodies to the HIV envelope. These are the antibodies measured in the most common HIV tests.



AIDS is the result of the progression of HIV infection and everyone with AIDS is infected with HIV, BUT not everyone with HIV infection has AIDS.. Anyone infected with HIV can still transmit the virus to another person—even though they appear healthy.

### Routes of HIV transmission:

- Having unprotected sex with an infected partner,
- Mothers transmitting HIV to their babies during pregnancy, labor and delivery, and breast feeding
- Transfusion with HIV-infected blood,
- Exposing an uninfected person's broken skin/mucous membranes or wound to blood or body fluids that are infected
- Using needles or syringes contaminated with HIV, and accidental cuts with sharp instruments contaminated with HIV.

**HIV is not transmitted through:** Casual contact such as sharing food, shaking hands, hugging, or "dry" kissing, Airborne exposure via a person who is coughing or sneezing or donating blood.



## How does HIV cause illness?

- HIV invades a specific type of cell within the immune system called the CD4 cell. These cells are the body's defense for fighting infections and illnesses.
- The CD4 cells die off slowly over a period of months or years.
- As the number of CD4 cells declines, the body becomes less and less able to fight off infections, and is said to become immune-suppressed.

## HIV disease Progression in Adults and Adolescents

HIV infection generally does not cause AIDS or death immediately. People can be infected for many years before becoming ill.

HIV disease progression has been classified into 4 clinical stages by WHO.

### WHO Clinical Stage 1:

Clients have no symptoms or may have generalized lymphadenopathy.

### WHO Clinical Stage 2:

Clients may have any of these symptoms: minor skin problems, herpes zoster, recurrent upper respiratory tract infections, weight loss less than 10% of body weight.

### WHO Clinical Stage 3:

Clients in this stage experience weight loss more than 10% of body weight, pulmonary TB, oral candidiasis (thrush), severe bacterial infections (pneumonia), and other diseases.

### WHO Clinical Stage 4:

This is the end-stage of HIV disease which is often called AIDS. In this stage, clients experience wasting syndrome, Pneumocystis jiroveci pneumonia (PCP), toxoplasmosis of the brain, Kaposi's sarcoma, lymphoma, extra-pulmonary TB, extra pulmonary cryptococcosis, and other diseases.

HIV disease in children has also been classified into 4 clinical stages, but the signs and symptoms that categorize each stage are a bit different and the normal values for CD4 cell counts are considerably higher in *children than adults*.

## The Window Period

The window period is the stage immediately after becoming infected but before the body has created antibodies. It usually takes the body 3-4 weeks to make enough antibodies to be detected by laboratory tests. In rare cases, it may take up to 3 months for laboratory tests to detect HIV antibodies in a person's body.

If people are tested during the window period, they will test negative even though they are infected because the body has not produced enough antibodies to trigger a positive test result.

**“Sero-conversion”** is a term used to describe the change when antibodies are produced and the blood tests positive. The virus can pass from one person to another during the window period.

**In children and infants under 18 months of age**, the antibody test cannot be used to determine infection definitively. HIV-infected mothers always pass their HIV antibodies to their baby in utero. Thus, 100% of infants born to HIV-infected mothers will have HIV antibodies and test antibody positive. However, a much smaller number of these infants are actually infected as the virus does not always pass to the baby.

Disease progression and response to therapy is determined by tracking the CD4 cell count and measuring the amount of virus in the blood (viral load).

### **Delaying HIV disease progression.**

Part of HIV testing and counseling is providing your clients who test HIV-positive with information about not spreading HIV to their partners and children, and also talking with those who are HIV-negative about how to remain uninfected.

HIV disease progression can be delayed by 3 types of clinical management:

- ◆ Prevention of opportunistic infections (OIs) (Septrin/Co-trimoxazole)
- ◆ Early treatment of OIs (examples Tuberculosis, pneumonia,) and tumours like Kaposi's sarcoma.
- ◆ Antiretroviral therapy -- HIV is a special type of virus called a "retrovirus". Therefore, treatment for HIV disease is called antiretroviral therapy. "Anti" means "against." Antiretroviral is often abbreviated as ARV. ARV drugs stop HIV from multiplying in the body. When these drugs are given to clients, their viral load decreases and their CD4 cell counts increase and hence the Immune function improves. But there is still no cure for AIDS or any vaccine available to prevent HIV transmission.

For treatment purposes, ARV drugs are NEVER given one at a time, but ALWAYS in combination. The first time clients are given ARV therapy, they are given 3 drugs. The only time that any ARVs can be given alone is in some regimens to prevent mother-to-child transmission. Pregnant women can be given a single dose of nevirapine to reduce their risk of transmitting HIV to their baby. Pregnant women may also be given a double therapy combination. Not all HIV-infected clients must be treated with ARVs at the time of diagnosis. Treatment with ARVs is not given until clients reach the later stages of illness.

### **Rapid Testing for HIV Diagnosis**

The most common laboratory tests used to diagnose HIV infection in adults and children over 18 months is detection of antibodies to the virus that are present in the blood or oral fluid. Antibodies are proteins produced by the body to fight infections. When someone is infected with HIV, their body makes antibodies to the viral external envelope (antigen), which can be measured with blood tests. The tests most commonly used to measure these antibodies are called "rapid tests" because they can be performed in a matter of minutes.

A sample (serum, plasma or whole blood) is tested with the first rapid test (Bioline) as per national testing algorithm. If this test yields a negative result, then the client is counselled as uninfected. However, an initial positive (or "reactive") test result has to be confirmed by a second rapid HIV test, which is Determine, on the same blood sample. If the results of those two tests differ, a third test is conducted using Unigold as a tiebreaker.

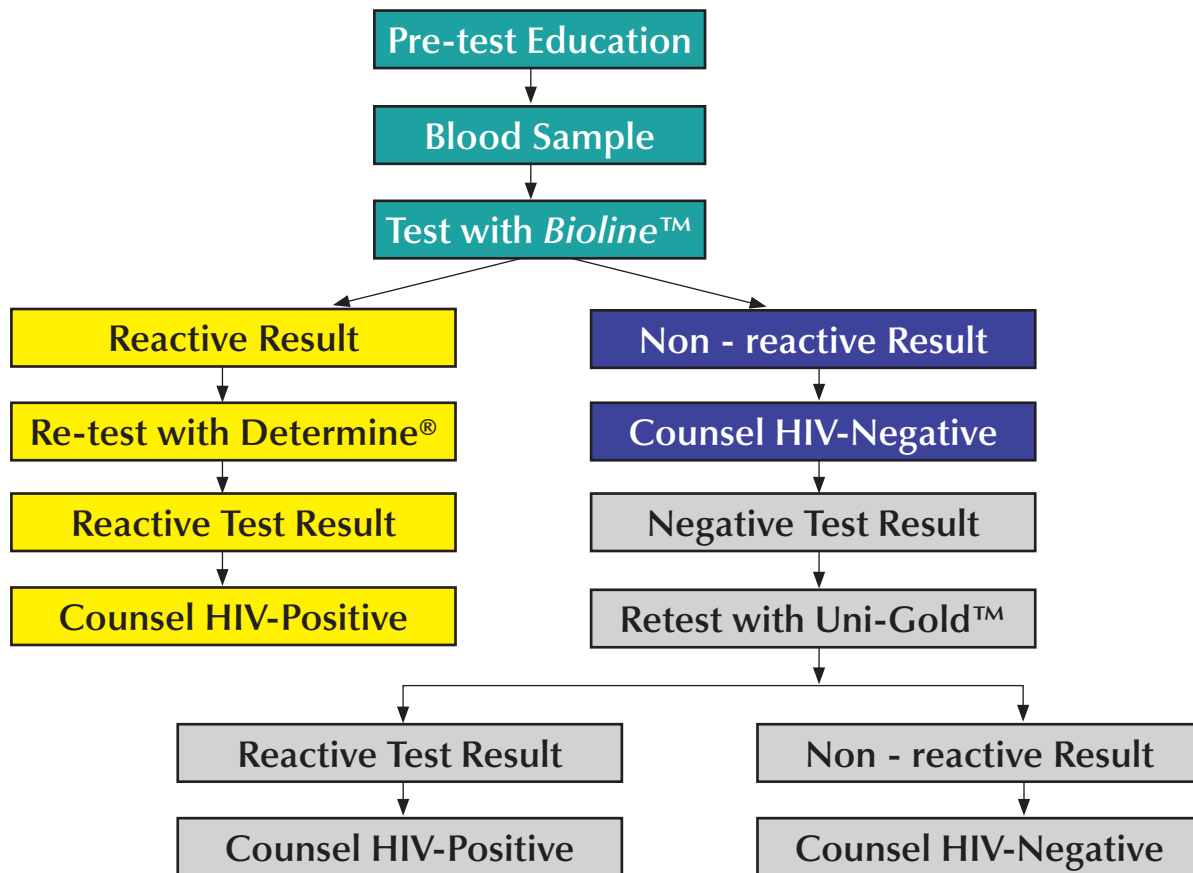
In performing HIV testing, healthcare workers should follow infection control procedures and Standard Precautions. Proper specimen collection procedures, including quality phlebotomy techniques, should be used and all samples should be labelled carefully and accurately. Special care should be taken to avoid contamination of testing reagents. All HIV tests results should be recorded on the client's Card and on the appropriate registers.

HIV tests should be performed by trained health care workers or laboratory technicians who should know how to interpret results and understand the testing procedure, including how to correctly dispose of all testing materials. Clients are tested either by the provider or by lab personnel using rapid testing methods that usually take 15-20 minutes to perform and analyze. If the test is performed in a lab, the results are returned to the provider. In some clinics, the provider may be trained to do the testing, so clients do not need to go to the lab. When the

results of the testing are available, the provider calls the client back into the room (same day, ideally within 30 minutes) and gives the results to the client.

## The National HIV Testing Algorithm

### National Serial Testing Algorithm



## Approaches to HIV Testing

There are two approaches to HIV testing in Tanzania – stand alone VCT and PITC ( Provider-initiated Counseling and Testing). VCT can occur at stand-alone VCT sites in the community, in a mobile counseling unit or in a health facility. Clients coming to these sites are: a) Seeking HIV testing b) More likely to be asymptomatic c) Expecting to get tested

In Tanzania, the national policy calls for routinely recommending HIV testing to every client who comes to a health facility, regardless of their problem. However, the reality of human or material resource constraints at some facilities may not allow for all clients to be tested. Consequently, it may be required that certain clients be given initial priority for PITC services like the Family planning clients.

PITC refers to HIV testing and counselling which is recommended by health care providers to persons attending health care facilities as a standard component of medical care. The major purpose of such testing and counselling is to enable specific clinical decisions to be made and/or specific medical services to be offered that will not be possible without knowledge of the person's HIV status.

## Similarities and Differences between the traditional model of VCT and PITC

### Similarities:

Both VCT and PITC:

- Are voluntary
- Require the consent of the client
- Test for the benefit of the client
- Require that the result be given to the client
- Are preferably done using a rapid test with a same day result

### Differences:

#### The differences between VCT and PITC

	Voluntary Counseling and Testing (VCT)	Provider-initiated HIV Testing and Counseling (PITC)
<b>Settings</b>	-- Stand-alone community sites -- Mobile units -- Health facilities	-- Health facilities
<b>Clients/Client</b>	-- Come to clinic specifically for HIV test -- Expect to get tested -- More likely to be asymptomatic	-- Come to clinic for a variety of reasons eg FP -- Not necessarily expecting HIV test
<b>Providers</b>	Usually trained HIV counselors, not necessarily trained as healthcare providers	Healthcare providers trained to provide education and abbreviated counselling on HIV
<b>Primary Purpose of HIV Counseling and Testing</b>	Primary focus is on preventing HIV acquisition through risk assessment, risk reduction, and testing	Primary focus is on identifying HIV-infected people and linking them with prevention, care, treatment, and support services
<b>Pre- and Post-test Counseling</b>	-- Client-focused counseling -- Usually a one-on-one encounter -- Is equally important for both HIV-negative clients and HIV-positive clients to know their results because of the importance of prevention	-- Provider recommends test as standard practice for anyone coming to the clinic -- Limited discussion about need for HIV testing -- Little time spent with those who test negative -- Primary focus on those who test positive with emphasis on their medical care and prevention
<b>Follow-up</b>	HIV-positive clients referred to medical care services and other support services, some in community	HIV-positive clients referred for medical care; additional support services, some in community

## **Provider-initiated HIV Testing and Counseling Process in the Context of FP Settings**

### ***Reasons to test clients in FP clinics for HIV?***

- The fact that they come for Family Planning services means they are sexually active and may be at risk of HIV infection or are already infected.
- It is a preventable condition, so testing may encourage clients who are uninfected to remain uninfected.
- To identify clients who may require care and treatment as HIV/AIDS is a serious disease
- WHO, UNAIDS, and Tanzania's national Guidelines for HIV Testing and Counselling in Clinical Settings have recommended that clients/patients in clinical settings be tested for HIV. HIV testing and counseling of clients in clinical settings is the standard of care and best medical practice.

### ***The major tasks in PITC in a FP context are:***

- Clients can receive PITC services only within a health facility and mobile health units
- Clients are coming to the clinic for a wide variety of reasons. Clients may not expect to get tested for HIV.
- Providers in these clinical settings are trained as FP providers and are providing HIV testing in addition to FP services.
- The primary focus is on identifying HIV-infected clients and linking them to prevention, care, treatment, and support services.
- Pre-test information is limited to a brief discussion about the need for HIV testing, and the provider recommends the test as standard practice for anyone coming to the clinic. However, HIV testing is still voluntary and clients may refuse the test (Opt Out).
- The provider spends little time with those testing negative. Instead, the primary focus is on those who test positive and their medical care, referral, and prevention counseling.

### ***Challenges of providing PITC in FP settings:***

- Stigma eroding clients' comfort or trust in the FP site
- Lack of human or material resources (and may be infrastructure) in clinics to provide this extra service may be an issue.
- The issue of HIV screening and ARV treatment of clinic staff.
- The need to establish and coordinate with HIV treatment and referral resources like HIV care and treatment services for those identified as HIV-positive within the clinics.
- Clinic staff, particularly providers, may feel uncomfortable talking with clients about HIV testing, and may not have been tested yet themselves. Also, Clinic staff may be HIV-positive and might therefore find it difficult to discuss issues of HIV with their clients.
- Many healthcare providers may be familiar with voluntary HIV counseling and testing (VCT) that is done in settings that often are not connected to a medical facility. They may view HIV testing as time-consuming, which may contribute to their reluctance to include HIV testing in the clinic setting not realizing that PITC does not require lengthy risk assessment and client-focused counseling that is part of VCT.

### ***HIV Testing in FP Settings is similar to Out-patient clinics or departments.***

Many clients will need to wait for some period of time after reporting at the clinic and before seeing the provider. This is an opportunity to provide FP and HIV information to clients and offer them both FP services and HIV testing and counselling.

Providing client education before the client sees the provider will help smooth the way. There are several options for pre-test education and information to clients prior to being seen by the provider.

- Group education by a health educator, such as a nurse, or by a peer educator. People living with HIV/AIDS can be trained as peer educators and are often very effective in this role. Group education means that all clients are gathered together as a group to hear a brief education lecture by a health educator or nurse.
- Brochures can be given to clients when they report at the clinic to read in the waiting room.
- Posters can be placed in waiting rooms and throughout the clinic on FP and noting the importance of knowing one's HIV status.

### **Initial Client encounter at the clinic**

During this clinic visit, the provider will give FP care for the client's needs, recommend testing for HIV and inform them that:

Many persons in the community have HIV.

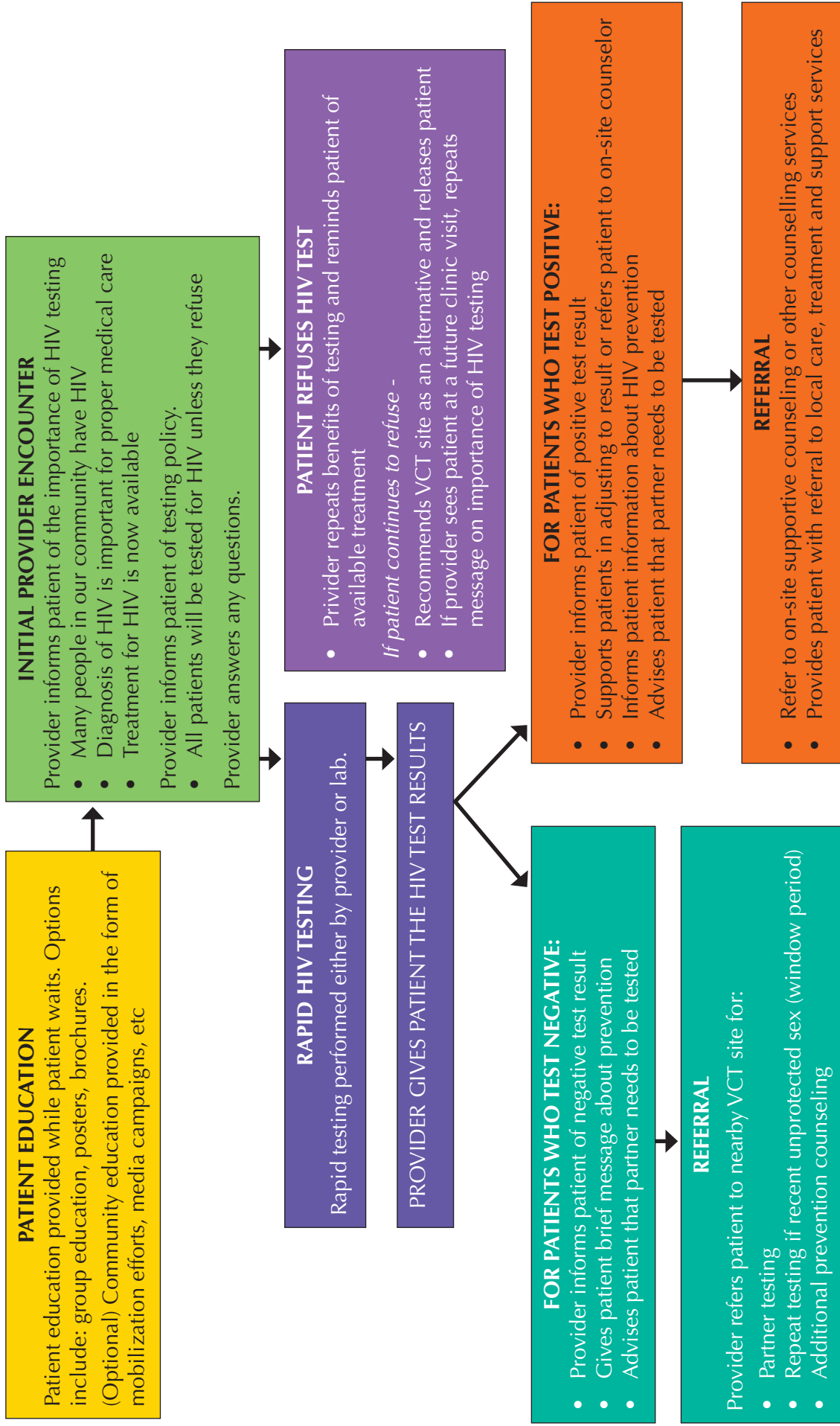
- Determining the HIV status is important for the future medical care of the client. For this reason, it is the clinic's policy to offer HIV test to all clients.
- HIV test will be done unless the client opts out.

The provider's job is to strongly encourage HIV testing, but clients still have the right to refuse testing if they do not think it is in their best interest.

Community mobilization efforts should be encouraged in order to inform community members about FP and PITC and motivate them to accept testing at their FP clinics.

## HIV Testing and Counseling in Clinical Settings

### PROTOCOL: Out-patient Clinic or Department



**Note:** This model may not work perfectly in every FP clinic setting. Each health facility may need to make slight modifications to suit their facility's specific needs.

## **HIV Testing.**

The provider will draw a blood sample from clients which will be tested at the FP clinic or sent to the lab for testing. It is recommended that the provider to conducts a rapid test at the FP clinic, for a client who needs results very quickly. It might also be possible for a provider to request a rapid HIV test be conducted in the lab. Generally, the lab will return results to the provider the following day.

When the test results are available, the provider will talk with the client in a private room or other confidential space in the FP clinic and deliver the results of the test.

Because information about HIV status is sensitive, client confidentiality must be observed. Thus, it is important that the records containing HIV results be kept in a safe place, usually a locked cabinet. These records should only be made available to other providers who need to know this information for client care.

### **For clients who test negative, the provider:**

- Informs the client of the negative test result
- Gives the client a brief message about HIV prevention
- Advises the client to encourage his or her sexual partner(s) to be tested as partner(s) may be positive
- Refers client to a nearby VCT site for partner testing, repeat testing if client had recent unprotected sex, and additional prevention counseling and explain Window Period.

### **For clients who test positive, the provider:**

- Informs the client of the positive test result
- Supports the client in adjusting to the result or refers the client to an on-site counselor
- Informs the client of the need for HIV care and treatment
- Gives the client information about HIV prevention
- Encourages the client to inform a family member and/or sexual partner(s) of their test results
- Advises the client of the need for their sexual partner(s) to be tested

The provider closes the client visit by giving the client a referral form to HIV care and treatment clinic (CTC) and provides information about HIV resources that may be available in the community.

## **Recording HIV results**

After completing the client visit, the results of the HIV test should be recorded into all records that providers use in caring for clients. This includes client registers or logbooks used to track the care and management of clients, as well as individual client records

Because information about HIV status is sensitive, client confidentiality must be observed. Thus, it is important that these records containing HIV results be kept in a safe place, usually a locked cabinet. These records should only be made available to other providers who need to know this information for client care.



## **CHAPTER 5:**

# **Anatomy of Female and Male Reproductive Organs and the Physiology of Menstrual Cycle**

### **Overview**

This chapter presents the anatomy of female and male reproductive organs, describe different hormones involved in the menstrual cycle and their chief functions, presents. Explain phases and changes in the menstrual cycle and the application of the menstrual cycle in FP/RH services.

# I. Anatomy of Female and Male Reproductive organs

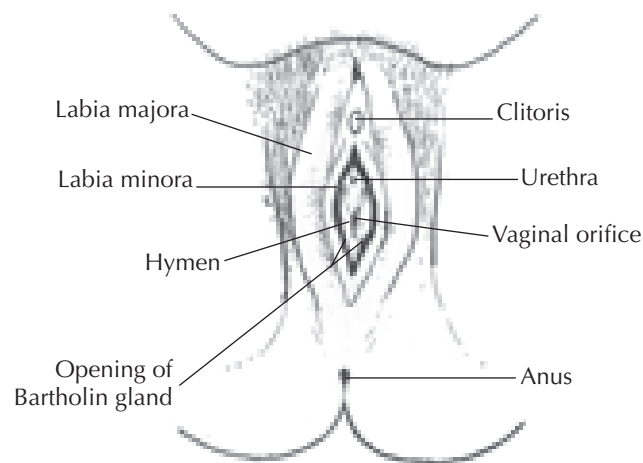
## A. Female Reproductive Anatomy

The female reproductive anatomy includes parts inside and outside the body.

### External female reproductive organs

The function of the external female reproductive structures (the genitals) is twofold: To enable sperm to enter the body and to protect the internal genital organs from infectious organisms. The main external structures of the female reproductive system include:

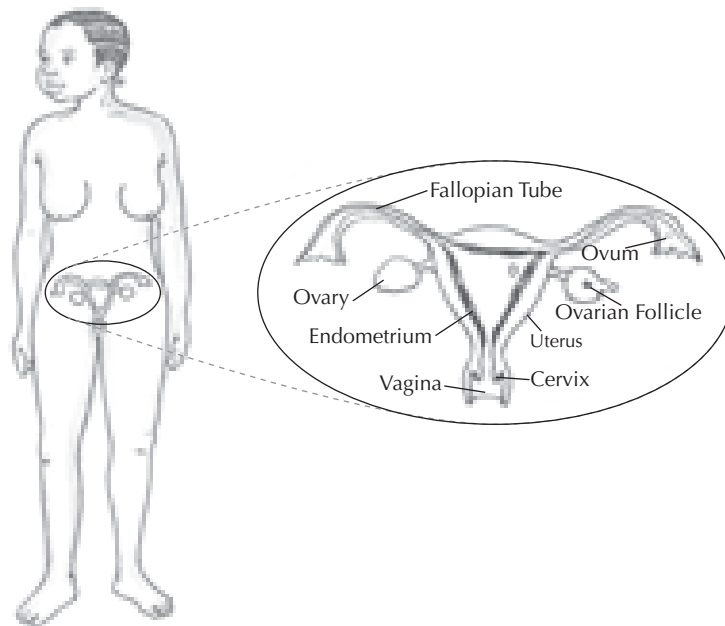
- **Labia majora:** The labia majora enclose and protect the other external reproductive organs. Literally translated as “large lips,” the labia majora are relatively large and fleshy, and are comparable to the scrotum in males. The labia majora contain sweat and oil-secreting glands. After puberty, the labia majora are covered with hair.
- **Labia minora:** Literally translated as “small lips,” the labia minora can be very small or up to 2 inches wide. They lie just inside the labia majora, and surround the openings to the vagina (the canal that joins the lower part of the uterus to the outside of the body) and urethra (the tube that carries urine from the bladder to the outside of the body).
- **Bartholin’s glands:** These glands are located beside the vaginal opening and produce a fluid (mucus) secretion.
- **Clitoris:** The two labia minora meet at the clitoris, a small, sensitive protrusion that is comparable to the penis in males. The clitoris is covered by a fold of skin, called the prepuce, which is similar to the foreskin at the end of the penis. Like the penis, the clitoris is very sensitive to stimulation and can become erect.



### Internal female reproductive organs

- **Vagina:** The vagina is a canal that joins the cervix (the lower part of uterus) to the outside of the body. It also is known as the birth canal.
- **Uterus (womb):** The uterus is a hollow, pear-shaped organ that is the home to a developing fetus. The uterus is divided into two parts: the cervix, which is the lower part that opens into the vagina, and the main body of the uterus, called the corpus. The corpus can easily expand to hold a developing baby. A channel through the cervix allows sperm to enter and menstrual blood to exit.

- **Ovaries:** The ovaries are small, oval-shaped glands that are located on either side of the uterus. The ovaries produce eggs and hormones.
- **Fallopian tubes:** These are narrow tubes that are attached to the upper part of the uterus and serve as tunnels for the ova (egg cells) to travel from the ovaries to the uterus. Conception, the fertilization of an egg by a sperm, normally occurs in the fallopian tubes. The fertilized egg then moves to the uterus, where it implants into the lining of the uterine wall.



## B. Male Reproductive Anatomy

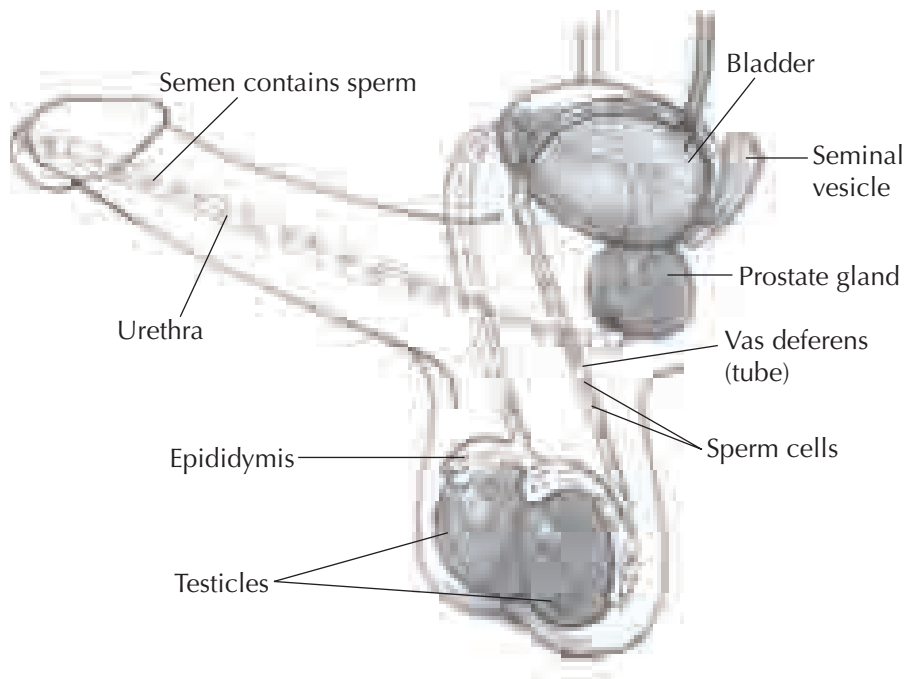
The organs and glands that make up the male sexual anatomy include:

- **Testicles** — After puberty, a man’s testicles, located at the base of the penis, produce male sex cells called sperm. Also starting at puberty, testicles produce testosterone, the male sex hormone. A man’s sperm production, once started, continues throughout his life; sexually mature males produce millions of sperm cells each day. The testicles are located below the penis, outside the body, where the appropriate temperature to make sperm may be maintained as it is several degrees too hot for sperm to be viable (able to fertilize eggs) inside the body.
- **Scrotum** — The testicles are covered by a pouch of skin called the scrotum. The scrotum and the muscles surrounding it can pull the testicles toward the body when they are too cold, and relax away from the body when the testicles are too warm. The scrotum also holds the epididymis.
- **Epididymis and vas deferens** — The epididymis stores the sperm after the testicles produce them, and the vas deferens transports the sperm from the epididymis to the urethra.
- **Urethra** — The urethra is a duct, or tube, that transports fluids from the inside of the body to the outside. In both men and women, the urethra is connected to the bladder and is used to pass urine out of the body. In males, however, the urethra is also connected to the “accessory glands,” which produce semen, and to the vas deferens, the duct that brings the sperm from the epididymus.
- **Penis** — The penis is perhaps the most visible part of the male sexual anatomy. It is made up of two parts, the shaft and the head (also called the glans.) The shaft houses the corpora cavernosa (two flexible cylinders comprised of erectile tissue that run the

length of the penis and support erections), and the corpus spongiosum (erectile tissue surrounding the urethra). In its reproductive capacity, the urethral opening at the tip of the penis delivers sperm into the vagina. Urine also flows out of the body through the urethral opening.

- **Accessory glands** — There are several glands that work together to produce semen, or seminal fluid. Sperm can live inside the female reproductive system for up to 48 hours, and seminal fluid helps the sperm move around and stay nourished. The seminal vesicle produces a fluid that provides energy to the sperm as they seek out the female sex cell, or the egg. The prostate gland makes a different fluid that helps the sperm move more quickly through the female reproductive system. Another set of glands, called bulbourethral or Cowper’s glands, makes a small quantity of fluid that helps protect the sperm on its way through the urethra by neutralizing any leftover traces of acidic urine.

## External and Internal Organ



## II. The Menstrual Cycle

**Knowledge of the menstrual cycle helps health care provider and clients to:**

Better understand mechanism of action of different FP methods

Better understand and manage menstrual side effects of some hormonal FP methods

Effectively counsel about fertile time so:

- women/couples who want to achieve pregnancy can time sexual intercourse to fertile window.
- women/couples who want to avoid pregnancy can ensure effective protection:

## Definition of common terms used in menstrual cycle

### Menstrual Cycle:

The monthly cycle of changes in the ovaries and the lining of the uterus (endometrium), in preparation for potential conception. Menstrual cycle starts on the first day of each menstruation and ends on the last day before the beginning of the next menstruation. The menstrual cycle varies in length and amount of bleeding according to age, weight, physical activity, level of stress and genetics.

### Menstruation:

Is blood which comes out as a result of shedding of the endometrium (inner lining of womb) on monthly basis if conception/fertilization does not take place.

### Ovulation:

The release of a mature ovum/egg from the ovary. This takes place on average 12 to 16 days before day one of the next menses. The ovaries normally alternate to ovulate. One mature follicle grows and gets to the surface of the ovary. It then ruptures to let the ovum out (ovulation). This ovum can live for up to 24 hours in the woman's body, after ovulation.

### Fertile window:

Fertile window refers to the days during menstrual cycle when pregnancy is possible. Sperm can survive a maximum of five days in woman's reproductive tract and egg can survive for about 24 hours after ovulation. Fertile window is thus six days long, comprised of the five days before ovulation and the day of ovulation.

### Female sex hormones:

These are chemical substances secreted by the brain (hypothalamus and anterior lobe of the pituitary gland) and the ovaries during different times of the menstrual cycle:

Gonadotropin-releasing hormone is secreted by the hypothalamus and stimulates production and secretion of FSH and LH.

Follicle stimulating hormone (FSH), Luteinizing hormone (LH) produced by the anterior lobe of the pituitary gland and influence what happens in the ovary.

Estrogen and progesterone produced as a result of growth and maturing of the follicle in the ovary.

### Male sex hormone:

Testosterone is produced in the testes. responsible for maintaining male characteristics e.g. masculine nature, deepening the voice, erection of penis, which makes the man able to ejaculate sperms in vagina.

**Corpus Luteum:** A small yellow structure that develops within a ruptured ovarian follicle, and secretes progesterone.

## The 3 phases of the menstrual cycle:

### 1. Menstrual Phase

- No pregnancy achieved leading to reduction of oestrogen and progesterone
- Degeneration of the endometrium with subsequent dismantling of the endometrium, leading to shedding and menstruation

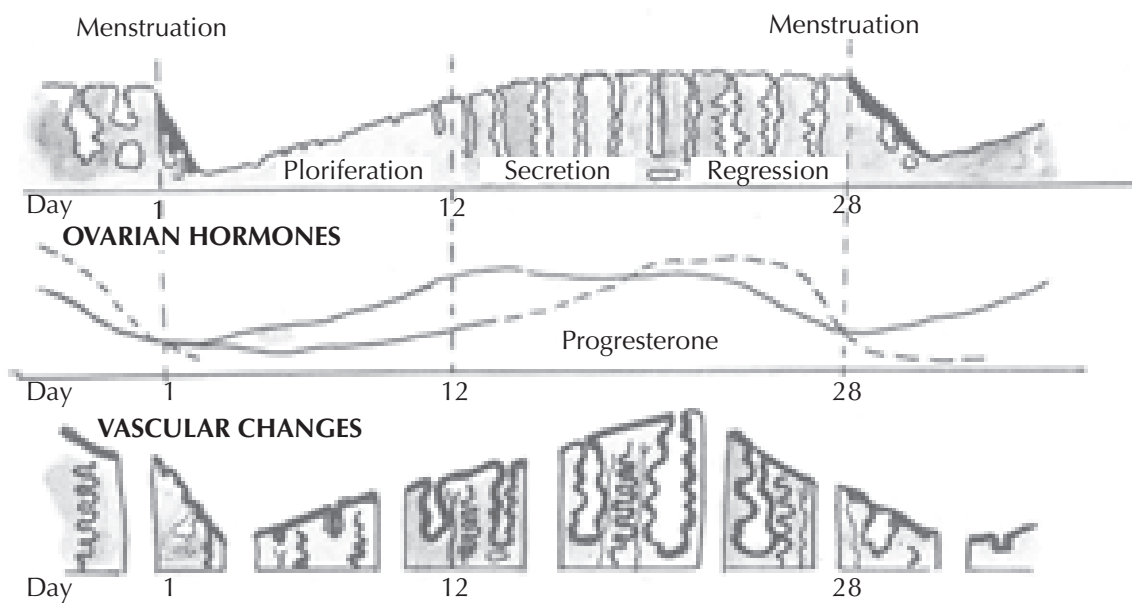
### 2. Proliferative Phase:

- FSH levels is elevated
- FSH stimulates the maturation of follicles and stimulates these follicles to produce oestrogen which is responsible for the thickening of the endometrium and secretion of the “fertile” cervical mucus.

### 3. Secretory Phase:

This starts soon after ovulation. Corpus luteum produces predominantly progesterone which makes *endometrium* receptive to *implantation* and supportive of the early pregnancy; it also has the side effect of raising the woman’s *basal body temperature*.

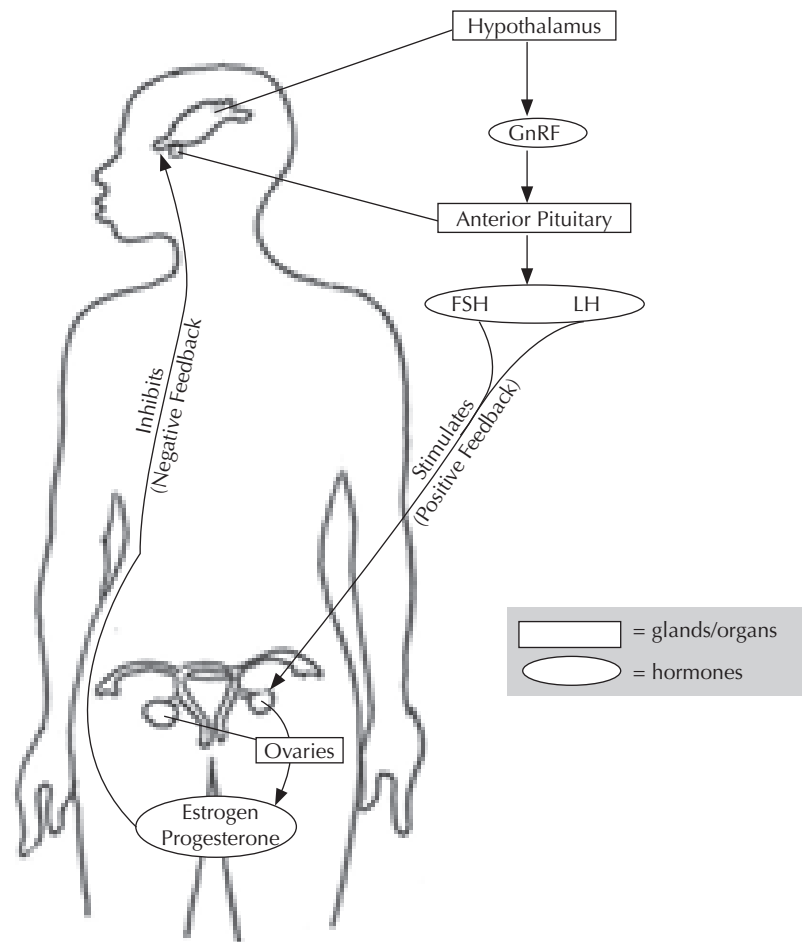
*The 3 phases of the menstrual cycle*



## Feedback mechanism

Feedback mechanism is a system which regulates the secretion of the hormones during the menstrual cycle. Various levels of hormones act like messages which are sent to the brain to produce or stop producing other hormones:

- (a) High levels of oestrogen in the blood will send the brain the message that follicle stimulating hormone should be reduced.
- (b) High levels of oestrogen will cause the release of luteinizing hormone.
- (c) High levels of progesterone will shut off the production of luteinizing hormone.
- (d) Low levels of oestrogen and progesterone will cause the release of follicle stimulating hormone.







## **CHAPTER 6:**

# **SCREENING CLIENTS FOR FAMILY PLANNING METHOD USE**

### **Overview**

This chapter covers procedures related to screening clients for eligibility of FP method use. It also includes procedures that may contribute to clients' general health and wellbeing but are not required for safe provision of FP methods. The procedures that the provider will perform depend on situations including the following:

- To rule out contraindications for the chosen method
- When the client chooses contraceptive methods that require certain procedures, for example prior to IUD insertion provider has to do bimanual and speculum pelvic examination.
- When the client requests to be examined due to some concerns.
- When the client history indicates a problem that requires further evaluation, for example possible STI symptoms.
- When procedures are done for the purpose of reproductive health promotion, for example breast examination, post partum assessment and cervical cancer screening.

In situations where procedures apply to both women and men, no distinctions will be made. Attention will be called to procedures that are applicable only to women or only to men.

## The WHO Medical Eligibility Criteria for Family Planning Method use

The World Health Organization (WHO) develops detailed criteria that health care workers can follow to determine which contraceptive methods are medically suitable for their clients. These criteria are based on the most current scientific knowledge about the effectiveness, risks, and benefits of various family planning methods, and they can help providers guide their clients in making safe and informed decisions.

The WHO **Medical Eligibility Criteria** (WHO MEC) is a set of recommendations to support the development of national guidelines for the safe provision of contraceptives. It is updated by a WHO expert working group every five years (or as needed), in order to reflect the latest clinical and epidemiological data.

The WHO MEC provides guidance on the safety of 19 contraceptive methods for women and men with specific characteristics or known medical conditions. The WHO MEC considers various individual characteristics (e.g., age, breastfeeding status) or health conditions (e.g., diabetes, hypertension) that may or may not affect eligibility for the use of each contraceptive method and classifies them into one of the following four categories.

Category	With clinical judgment	With limited clinical judgment
1	Use method in any circumstances	Yes Use the method
2	Generally use: advantages outweigh risks	Yes Use the method
3	Generally DO NOT use: risks outweigh advantages	No DO NOT use the method
4	Method NOT to be used	No DO NOT use the method

The following quick reference guide, in the form of a chart, summarizes the WHO's medical eligibility criteria for combined oral contraceptives, the injectable contraceptive depot-medroxyprogesterone acetate (DMPA), progestin-only implants, and copper IUDs.

Medical Condition	Combined Oral Contraceptives (COC)				Injectable Contraceptive (DMPA)	Progestin-Only Implants	Copper IUD
	1-2	3	4	5			
<b>Quick Reference Chart for the WHO Medical Eligibility Criteria for Contraceptive Use</b>							
<b>Contraindications</b>							
<b>Relative Contraindications</b>							
<b>Medical Conditions</b>							
<b>Cardiovascular</b>							
<b>Diabetes Mellitus</b>							
<b>Hypertension</b>							
<b>Thrombotic Disorders</b>							
<b>Smoking</b>							
<b>Other</b>							
<b>Relative Contraindications</b>							
<b>Cardiovascular</b>							
<b>Diabetes Mellitus</b>							
<b>Hypertension</b>							
<b>Thrombotic Disorders</b>							
<b>Smoking</b>							
<b>Other</b>							

## Screening Procedures for Providing Family Planning methods

There are a number of screening procedures for providing family planning methods, including: History taking, Breast examination by provider, Pelvic/genital examination, Cervical cancer screening, Routine laboratory tests, Hemoglobin test, STI risk assessment: medical history and physical examination, STI/HIV screening: laboratory tests, and Blood pressure screening.

The WHO has classified procedures that are needed by method as shown in the table below. Procedures are classified into three classes:

- **Class A:**  
Essential and mandatory in all circumstances for safe and effective use of the contraceptive method.
- **Class B:**  
Contributes substantially to safe and effective use. If the test or examination cannot be done, however, the risk of not performing it should be weighed against the benefits of making the contraceptive method available.
- **Class C:**  
Does not contribute substantially to safe and effective use of the contraceptive method.

Screening for most methods use can be done through the use of a screening checklist administered by a provider through history taking with a client as further explained in the specific method chapters, including for oral contraceptives, injectables, and implants. No further examinations are needed for a client to be initiated with a method. For certain methods such as IUDs, and sterilization, further examinations need to be conducted in addition to administration of the screening checklists, including pelvic examinations.

Screening Procedure	Combined oral contraceptives	Monthly injectables	Progestin-only pills	Progestin-only injectables (Depo-Provera)	Implants	IUDs	Male and female condoms	Female sterilization	Vasectomy
<b>Breast examination by provider</b>	C	C	C	C	C	C	C	C	N/A
<b>Pelvic/genital examination</b>	C	C	C	C	C	A	C	A	A
<b>Cervical cancer screening</b>	C	C	C	C	C	C	C	C	NA
<b>Routine laboratory tests</b>	C	C	C	C	C	C	C	C	C
<b>Hemoglobin test</b>	C	C	C	C	C	B	C	B	C
<b>STI risk assessment: medical history and physical examination</b>	C	C	C	C	C	A*	C	C	C
<b>STI/HIV screening: laboratory tests</b>	C	C	C	C	C	B*	C	C	C
<b>Blood pressure screening</b>	‡	‡	‡	‡	‡	C	C	A	C§

\* If a woman has a very high individual likelihood of exposure to gonorrhea or chlamydia, she generally should not have an IUD inserted unless other methods are not available or not acceptable. If she has current purulent cervicitis, gonorrhea, or chlamydia, she should not have an IUD inserted until these conditions are resolved and she is otherwise medically eligible.

- † *Women at high risk of HIV infection or AIDS should not use spermicides. Using diaphragms and cervical caps with spermicide is not usually recommended for such women unless other more appropriate methods are not available or acceptable.*
  - *NA=Not applicable*
- ‡ *Desirable, but in settings where the risks of pregnancy are high, and hormonal methods are among the few methods widely available, women should not be denied use of hormonal methods solely because their blood pressure cannot be measured.*
- § *For procedures performed using only local anesthesia.*

## I. Taking Social-Medical, Obstetric and Gynaecological History

This involves asking a client a series of questions based on WHO's Medical Eligibility Criteria for Contraceptive Use to determine whether a client (1) is a good candidate for the chosen method, (2) will need further evaluation, or (3) should choose another family planning method.

To initiate use of certain methods such as combined oral contraceptives, the injectable contraceptive depot-medroxyprogesterone acetate (DMPA), progestin-only implants, and copper IUDs etc., providers must be reasonably sure that the client is not pregnant. One reason for this is that women who are pregnant do not require contraception. Furthermore, in the case of an IUD, this device should never be inserted into the uterus of a pregnant woman because it could lead to a septic miscarriage, which is a serious complication. Ruling out pregnancy can also be done by asking a client a series of questions question describes a situation that effectively prevents a woman from becoming pregnant.

Women who are in the first seven days of their menstrual cycle, who have had a miscarriage or an abortion in the past seven days, or who are in their first four weeks postpartum are protected from unplanned pregnancy because the possibility of ovulation in each of these situations is extremely low. Women who satisfy the three Lactational Amenorrhea Method

(LAM) criteria (i.e., they are in their first six months postpartum, are fully or nearly-fully breastfeeding, and are amenorrheic) are also protected from unplanned pregnancy because of the effects of lactational amenorrhea on the reproductive cycle. Likewise, women who consistently and correctly use a reliable contraceptive method are effectively protected from pregnancy, as are those who have abstained from sexual intercourse since their last menstrual period.

### Advance Preparations:

Prepare the materials and forms required, for example:

- Screening job aids
- RCH No. 5 (women)
- Surgical Contraceptive Client Record booklet and outpatient record (men)

### Procedural Steps:

- Explains purpose and process and reassure client of confidentiality
- Ask the client a series of questions listed in the method specific chapters under "**Screening for Medical Eligibility**". These questions represent conditions listed under category 3 and 4 of the WHO MEC. Questions under category 1 and 2 do not need to be asked because the recommendation is that clients with these conditions can safely use the method. If the client answers NO to all the questions, she is a good candidate for the chosen method and initiation procedures can follow.

- Using the Pregnancy Checklist, ask the client a series of questions to be reasonably sure she is not pregnant. If the client answers YES to any question, and is free from signs and symptoms of pregnancy, providers can be 99 percent sure she is not pregnant.
- Record legibly clients' social, medical, obstetrical and gynecological history on client RCH No. 5 Family Planning Card and use the checklist below. In addition to the checklist, you can also review the information recorded on the RCH No. 5 card to determine clients' suitability/eligibility for FP method use or need for physical examination or further counseling. Note the RCH No. 5 Card contains comprehensive information about the client's social, medical, obstetrical and gynecological history. Some of this information is not necessary to initiate certain methods to a client. For example: the RCH No. 5 card has a component on vaginal exam: Speculum Exam. A client who wants to use oral contraceptives, depo-provera, and implants do not need to have this exam done to initiate use of their method. It is important that only essential and mandatory procedures for specific methods are conducted to avoid barriers to accessing family planning methods.
- Share the findings in a reassuring manner with the client
- Ask client to what extent she is aware of any abnormal findings, their significance, risk and danger
- Encourage the client to share reactions to the information while gently probing as necessary
- Inform the client of the next steps
- Refer the client for further evaluation or treatment if necessary
- Thank the client for agreeing to proceed with the next steps







## Pregnancy Screening Checklist for initiation of FP method

(How to be reasonably sure that the woman is not pregnant)

Ask the client questions 1–6.

As soon as the client answers “yes” to any question, stop and follow the instructions below.

NO		YES
	1 Did you have a baby less than 6 months ago, are you fully or nearly-fully breastfeeding, and had no monthly bleeding since then?	
	2 Have you abstained from sexual intercourse since your last monthly bleeding or delivery?	
	3 Have you had a baby in the last 4 weeks?	
	4 Did your last monthly bleeding start within the past 7 days (or within the past 12 days if the client is planning to use an IUD)?	
	5 Have you had a miscarriage or abortion in the last 7 days (or within the past 12 days if the client is planning to use an IUD)?	
	6 Have you been using a reliable contraceptive method consistently and correctly?	



If the client answered “no” to all questions, pregnancy cannot be ruled out. The client should wait for her next monthly bleeding or use a pregnancy test.



If the client answered “yes” to at least one of the questions, and she has no signs or symptoms of pregnancy, you can give her the method she has chosen.

## II. Conducting Physical Examination - Head to Toe Examination (where indicated or requested)

Physical examinations should only be conducted where indicated or requested by a client. For example breast examinations are not considered essential and mandatory for safe and effective use of the contraceptive method.

### Advanced preparation - equipment and supplies:

- Mackintosh, draw-sheet and bed sheet
- Bedside lamp or torch
- Blood pressure cuff
- Scale
- Bedside screen if necessary
- Soap and water
- Waste bin
- RCH No. 5 Family Planning card
- Wash hands before starting the procedure

## Procedural Steps:

### Conducting general examination (where indicated or requested):

- Take client's blood pressure and record
- Weigh the client and record the reading before client climbs on the couch
- Inspect for puffiness, paralysis and anxiety
- Check for jaundice and anaemia (eyes and tongue)
- Inspect for swellings or goitre
- Chest structure and movement
- Check for breathing abnormalities

### Conducting Breast Examination - women only (where indicated, requested, or as part of RH promotion):

- Explain to the client what you are going to do
- Ask the client to put arms on the sides **while seated** on the couch
- **Inspect the breasts for:**
  - ♦ Mass or lumps
  - ♦ Size and shape of breasts and nipples
  - ♦ Unusual skin discolouration
  - ♦ Discharge from the nipples
  - ♦ Darkening of areola (possible signs of pregnancy)
  - ♦ Check for dimpling and retraction of the breasts
  - ♦ Inspect breasts as client rise her hands towards the head for to see whether breasts rise together or are symmetrical



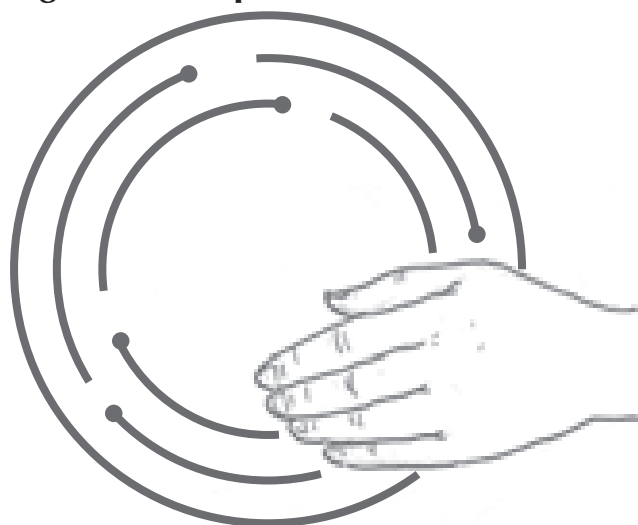
- **Palpation:**

- ♦ Ask the client to **lie down** on the couch on her back and to put one arm over the head
- ♦ Start palpating one area at a time, pressing gently against the chest and moving the fingers in a circular motion without leaving any part untouched, until the whole breast is covered, including the nipple and tail of the breast and axillae (See Fig. 1, 2 & 3)

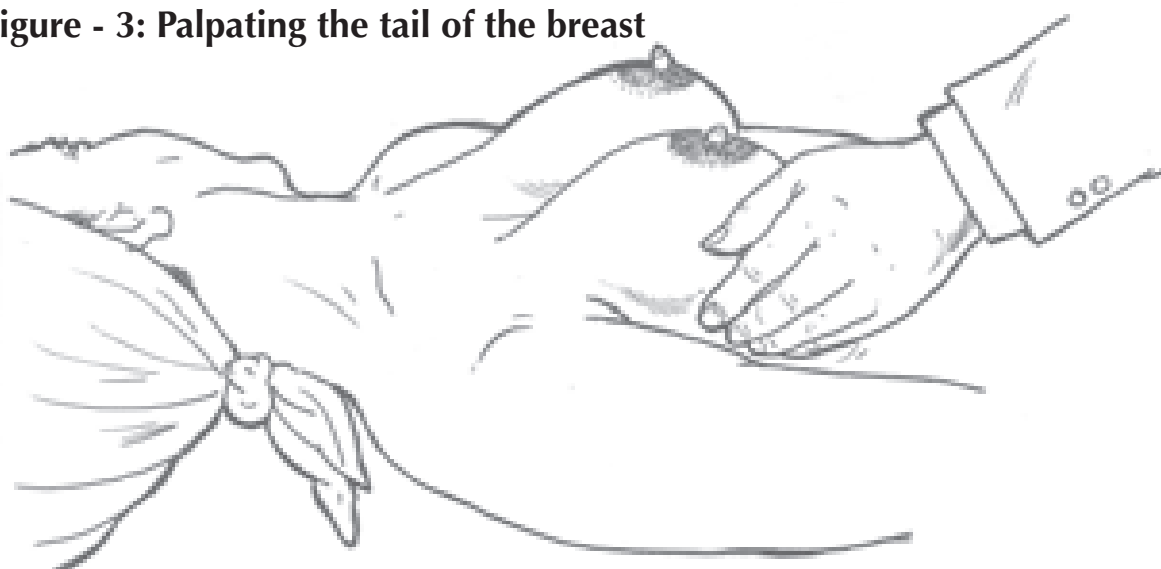
**Figure 1: Using the flat area of the fingers to palpate the breast**



**Figure - 2: Palpation of the breast**



**Figure - 3: Palpating the tail of the breast**



- ◆ For pendulous breasts support with one hand and palpate all areas of the breast
- ◆ Observe the client's facial expression for signs of pain or tenderness as you palpate the breasts

- ◆ Gently squeeze the nipple to check for any discharge. (See Fig. C-4).
- ◆ Dry off discharge with a dry gauze swab, if applicable.

**Figure - 4: Squeezing the nipple**



- Repeat the same procedure for the other breast with the client's other hand under the head
- Share the findings with the client
- Inform the client of the next step

### **Teaching client self-breast examination (women only)**

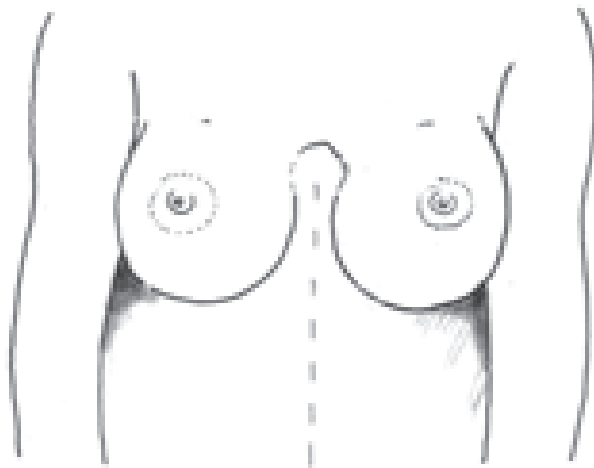
- Explain to the client the purpose of self-breast examination, that is, to detect abnormal growths and other problems of the breasts, so that treatment can be instituted early
- Explain the procedure to the client
- Allow the client to ask questions and respond, making sure to explain further what seems unclear to the client
- Emphasize to the client the importance of examining her breasts monthly within 3 – 5 days after menstruation because the breasts at that time are softer OR to pick a specific date in a month for non-menstruating clients
- Advise the client to look at her breasts in a large mirror, to observe any abnormal changes in their size and skin, dimpling and retraction of the nipples
- Assist client to palpate the breasts:
  - ◆ Ask the client to lie down on the couch and expose the breasts only
  - ◆ Place a pillow under the shoulder blade of the side of the breast being examined and explain the reason for this action
  - ◆ Explain to the client the importance of placing one hand under the head during breast examination

- ◆ Ask the client to put the fingers together, and holding her hand, help her to palpate the breast using the flat surface of her finger tips in a circular movement, starting from near the axillae and finishing around the nipple. (See Fig.3)
- ◆ Help client palpate the tail of the breast and the axillae for lumps
- ◆ Help the client to squeeze the nipple and to look for any abnormal discharge
- ◆ Assist the client to repeat the examination of the second breast, its tail and axillae.
- ◆ Correct missed steps
- Ask the client to repeat the self-breast examination without your assistance
- Correct any inappropriate or missed steps
- Let the client feel the abnormal lumps in the model if available to get familiar with abnormal lumps
- Thank and commend client for co-operation

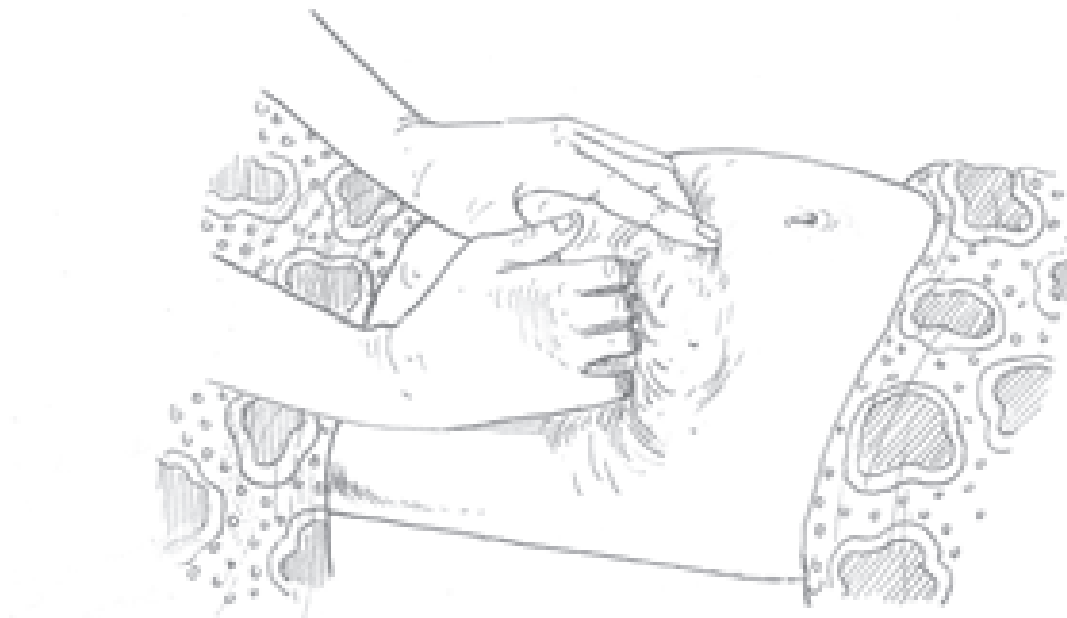
### **Conducting abdominal examination (where indicated or requested)**

- Explain to the client what you are going to do
- Expose the abdomen, from the base of the rib cage to the pelvic bone
- Inspect abdomen for:
  - ◆ Condition of the skin
  - ◆ Previous surgical scars
  - ◆ Abdominal distension
  - ◆ Obvious mass
- Palpate the abdomen:
  - ◆ Divide the abdomen into four imaginary quadrants. (See Fig. -5).
  - ◆ Ask the client if she/he has any abdominal pain or discomfort. Let the client point to the area and examine that area last
  - ◆ Gently and lightly palpate each quadrant using the flat surface of fingers without missing an area
  - ◆ Observe client's facial expression and body movement as you palpate. Ask the client to take a deep breath and while she breathes out push the abdomen down deeply to palpate the liver in the right quadrant. Check for enlargement, tenderness and consistency. (See Fig. -6)
  - ◆ Check for size, shape, consistency, tenderness and mobility of any masses
  - ◆ Press lower abdomen slowly and firmly, then quickly withdraw your hand to check for rebound tenderness
  - ◆ Inspect and palpate the groin for sores or any swelling
- Wash hands with soap and water

**Figure - 5: Quadrants of the abdomen**



**Figure - 6: Palpation of the liver.**



### **Conducting abdominal examination for post-partum/post-abortal clients – women only**

(Six to eight weeks after delivery or four weeks after abortion/miscarriage)

- Palpate the lower abdomen for involution of the uterus
- Check rectus abdominal muscles for weakness and separation by putting the edge of the palm along the linea alba and asking the client to try to sit up or lift client's head while applying pressure along the linea alba See Fig.-7)
- Share findings on abdominal examination, reassure client and advise on exercises to strengthen the muscles

**Figure - 7: Palpation along linea alba with client trying to raise her head and feet.**



### **Conduct examination of lower limbs (if indicated or requested)**

- Inspect lower limbs for varicose veins and oedema
- Press firmly above the ankle or over the tibial bone for a few seconds to examine for oedema
- Palpate calf muscles for tenderness
- Share findings with the client
- Wash hands with soap and water

### **III. Performing Pelvic Examination – women only (where indicated or requested)**

#### **Advanced preparation - equipment and supplies:**

- Mackintosh, draw-sheet and bed sheet
- Examination couch
- Bedside lamp or torch
- Gloves
- Pelvic examination tray with speculum, forceps (if pelvic exam is done as part of IUCD insertion procedure, tray should include all instruments necessary for IUCD insertion – see IUCD chapter)
- Bedside screen if necessary
- Soap and water
- 3 plastic containers with lids for decontamination process
- Waste bin
- RCH No. 5 Family Planning card
- Wash hands before starting the procedure

## Procedural Steps:

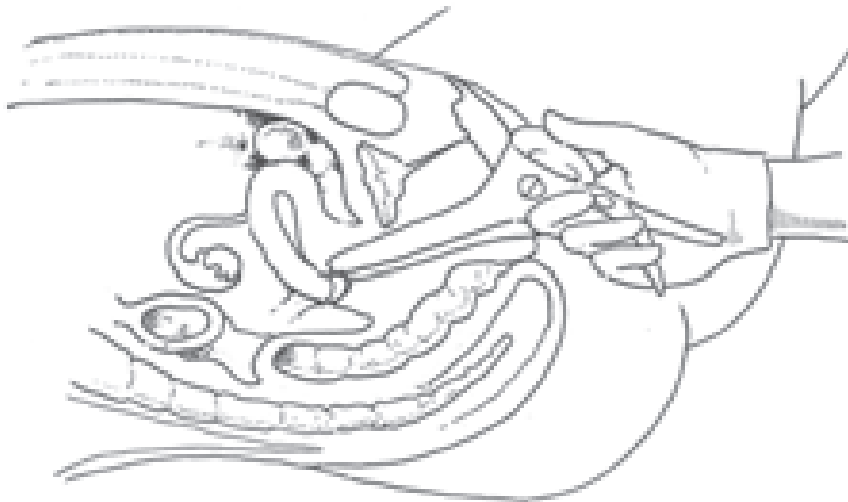
- **Prepare for pelvic examination:**
  - ♦ Cover examination couch with sheet, mackintosh and draw-sheet
  - ♦ Set up the sterile tray and other materials
  - ♦ Inform client about the procedure to be performed and the purpose
  - ♦ Ask client to go and empty the bladder
  - ♦ Ask the client to undress the part of the body to be examined and cover herself with a piece of a cloth available
  - ♦ Help the client climb on to the examination couch
  - ♦ Position the client in a lithotomy position (on the back with knees bent, positioned above the hips, and spread apart usually through the use of *stirrups*)
  - ♦ Wash hands with soap and water
  - ♦ Put on clean gloves
  - ♦ Ask client to pull up the draw sheet or cloth to expose only the lower half of the body
- **Examine the external genitalia**
  - ♦ Inspect the vulva for sores, scars and vaginal discharge (colour, amount and odour)
  - ♦ Separate the labia majora and examine the vulva for sores and discharge
- **Perform speculum examination:**
  - ♦ Inform the client when ready to insert the speculum
  - ♦ Reassure client that the examination may be uncomfortable but not painful
  - ♦ Hold the speculum between the index and the middle finger, keeping the blades closed
  - ♦ With the other hand, spread the labia and insert the speculum obliquely into the vaginal canal making sure not to clamp the skin and hair between the blades and avoid pressing on the urethra and clitoris. When the blades are halfway into the vaginal canal, turn speculum in horizontal position. (See Fig. C-8)

**Figure C-8: Inserting the speculum**



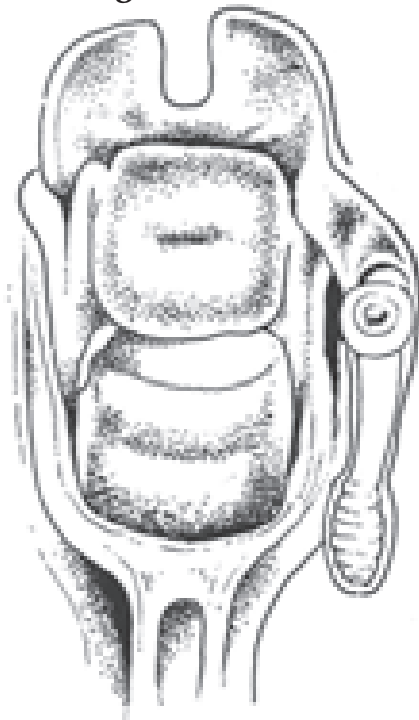


**Figure -9: Opening the speculum**



- Gently push the speculum towards the cervix and open the blades to expose the cervix
- Tighten the speculum screw to maintain the speculum in position. (See Fig. C-10)

**Figure -10: Viewing the cervix and vaginal walls.**



- Take any relevant specimens for laboratory tests if indicated
- If the client is bleeding or has a profuse vaginal discharge, sponge with swab
- Observe the cervix for colour, sores, growths and discharge
- Observe the vaginal walls for colour sores, growths and discharge colour, amount, consistency and odour
- Unscrew the speculum and gently pull it out halfway and close the blades
- Turn speculum in oblique position and then remove
- Observe the speculum for the nature of discharge
- Submerge the speculum in chlorine - 0.5% solution to decontaminate for 10 minutes
- Share findings with the client and explain the next step of bimanual pelvic examination.

- **Perform bimanual vaginal examination:**

- Explain the procedure to the client
- Separate the labia majora and minora to expose the vaginal orifice
- Insert two fingers (index and middle fingers) into the vagina
- Palpate the Bartholin's glands situated at four (4) and eight (8) o'clock positions of vaginal orifice
- Ask the client to cough or bear down to inspect the anterior and posterior walls of the vagina for bulging, in order to rule out cystocele and rectocele
- Check the muscle tone by asking the client to tighten vaginal muscles to squeeze the fingers inside the vagina.
- Explain to the client to do this exercise at home as often as she can to strengthen vaginal muscles
- Palpate the cervical os to check for opening or closure, feel for growths, consistency and regularity. (See Fig. -11)

**Figure -11: Examining the cervix**

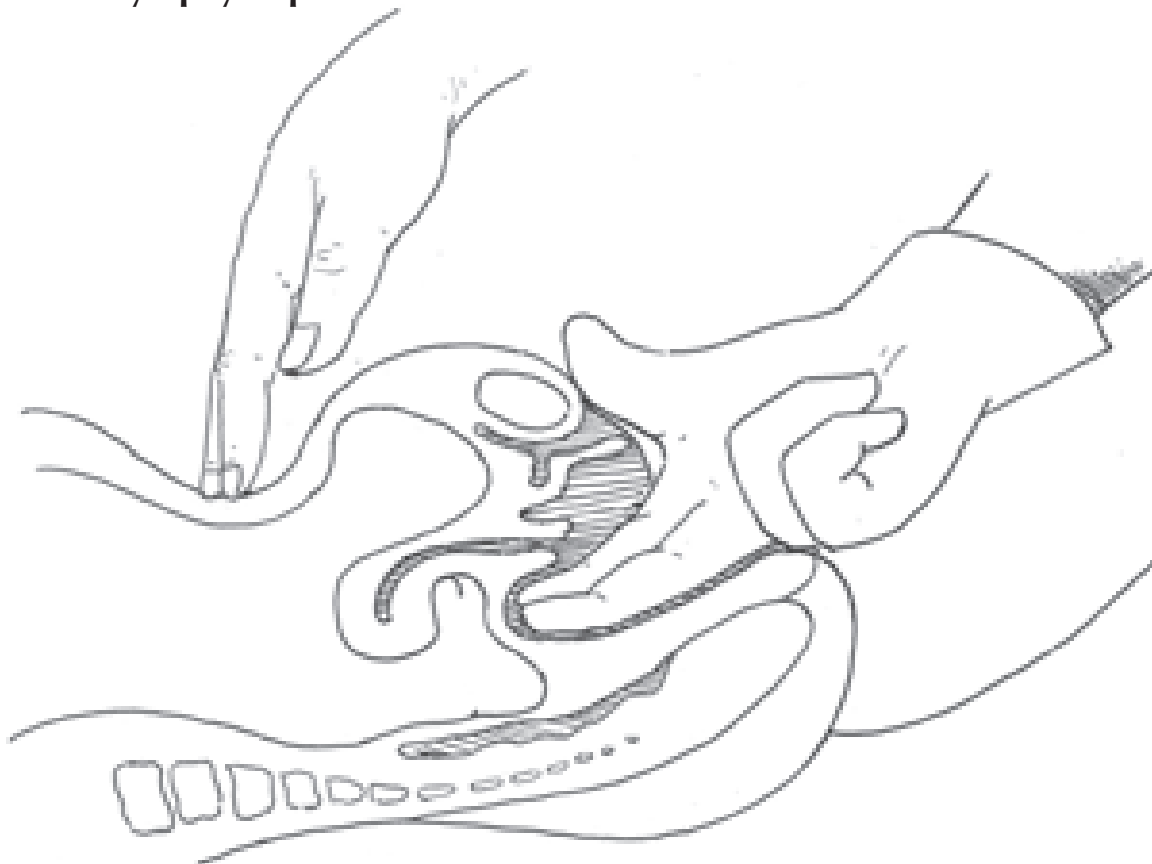


- With the fingers in the lateral fornix, push the cervix to the opposite side to perform a cervical excitation test while observing the client's facial expression. If the client experiences pain, this may indicate inflammation in the adnexae
- **If you are planning to do an IUCD insertion, identify position of the uterus:**
  - Place the other hand gently on lower abdomen above the symphysis pubis and push it downwards to steady the uterus
  - With the fingers in the vagina, place them below the cervix and gently lift the cervix towards the hand on the abdomen
  - Palpate the body of the uterus to identify the uterine position: Anteverted or mid line or retroverted. (See Fig. C-12, 13)

**Figure -12: Anteverted position: Easily felt os points towards the sacrum**

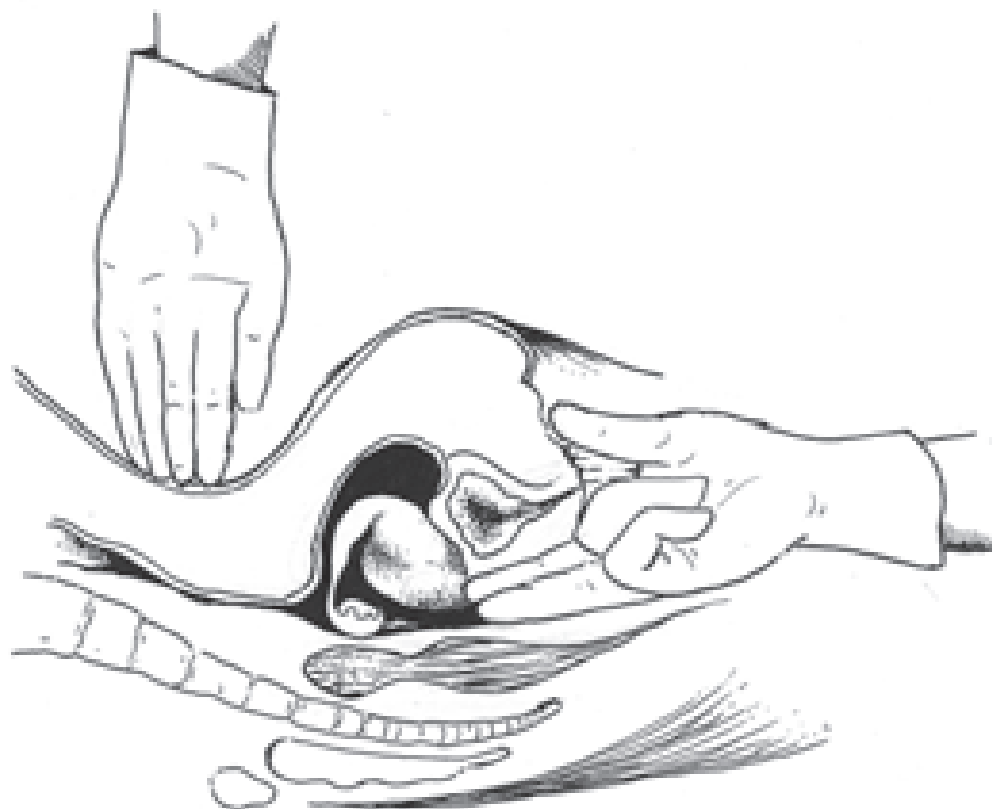


**Figure -13: Retroverted uterus: Cannot easily be felt bimanually. Os points towards symphysis pubis**



- As soon as the position of the uterus is identified, make a 'V' with fingers and place the cervix in the middle of the V and try to outline the uterus by 'walking up' the body of the uterus with the abdominal hand to feel for the shape, size, consistency and mobility (See Fig.-14)

**Figure -14: Outlining the uterus with fingers**



- Move both the abdominal and vaginal hand to one side of the adnexae while observing the client for signs of tenderness to palpate gently for mass in the ovary and tubes. A normal ovary is soft, small and very difficult to feel
- Repeat the palpation of the adnexae on the other side of the uterus while observing the client for signs of tenderness
- Withdraw the fingers slowly and as you withdraw with the palm facing upwards, sweep the urethra to milk any secretion
- Bring the fingers outwards and palpate the Skene's glands for enlargement and discharge
- Withdraw fingers slowly and gently and inform the client the procedure is over
- Ask client to get off the couch, dress up and sit on the chair
- Decontaminate the couch
- Remove the gloves and dispose in a waste bin
- Wash hands with soap and water
- Finish by discussing the findings with the client and thank her for co-operation
- Record the findings on the client's RCH. No. 5: Family Planning Card
- Manage the abnormal findings or refer as necessary.

### **Performing genital examination in man (where indicated or requested)**

- Wash your hands before the examination and put on clean gloves
- Tell the patient what you are going to do as you perform each step of the examination
- Ask the patient to stand up and lower his underpants to his knees. Some providers prefer the man to lie down during the examination

- Palpate the inguinal region (groin) looking for enlarged lymph nodes and buboes
- Palpate the scrotum, feeling for the testis, epididymis, and spermatic cord on each side
- Examine the penis, noting any rashes or sores
- Ask the patient to pull back the foreskin if present and look at the glans penis and urethral meatus
- If you do not see any obvious discharge, ask the patient to milk the penis
- Ask the patient to turn his back to you and bend over, spreading his buttocks slightly. This can also be done with the patient lying on his side with the top leg flexed up towards his chest
- Examine the anus for ulcers, warts, rashes, or discharge
- Wash your hands following the examination
- Record findings, including the presence or absence of hernias, ulcers, buboes, genital warts, and urethral discharge, noting colour and amount.
- Discuss findings and implications
- Refer or treat depending on findings



## Short-Acting Methods

Short acting methods include both contraceptives containing hormones and non-hormonal methods of contraception. The short acting hormonal methods are the most popular contraceptive methods and they are reversible - that is a woman can become pregnant again once she stops using the contraceptive.

The non-hormonal short-acting methods of contraception are an alternative for women who cannot or do not wish to use hormonal methods of contraception, or who need protection from STIs in addition to pregnancy protection.

### Different types of short-acting contraceptive methods.

#### Hormonal Contraceptive Methods:

- Combined Oral Contraceptives (COC).
- These are pills which contain low doses of two hormones, a progesterone and estrogen.
- Progestin Only Pills (POP)-contain only one hormone.
- Emergency Contraceptive Pills (ECPs).-Used to prevent pregnancy following unprotected act of sexual intercourse.
- Depo Provera®
- It is a three monthly injection that contains progestin only. It is very reliable, as it suppresses ovulation and makes the cervical mucus impenetrable for sperm.

#### Non Hormonal Contraceptive Methods:

##### **Barrier methods:**

- Male condom.  
The male condom is a barrier device used during sexual intercourse to reduce the likelihood of pregnancy and spreading sexually transmitted infections (STIs). It is put on a man's erect penis and physically blocks ejaculated semen from entering the woman's vagina. The male condoms are waterproof, elastic and durable.
- Female condom.  
A female condom is made of polyurethane (a thin, transparent, soft plastic). It is a device that is used during sexual intercourse to prevent pregnancy and reduce the risk of sexually transmitted infections (STIs). It is worn internally (vaginally) by the woman and physically blocks ejaculated semen from entering the woman's vagina. The female condom is a pouch with flexible rings at each end. Before intercourse the inner ring is inserted deep into the vagina, and the outer ring is placed over external genitalia, holding condom in place.

##### **Natural FP methods:**

Natural family planning methods include fertility awareness based methods, withdrawal and the lactation amenorrhea method. The basic idea of the fertility awareness based methods is to determine the fertile and infertile days of the menstrual cycle by self observation.

The withdrawal method is based on the ability of male partner to withdraw the penis out of vagina before ejaculation; while the lactation amenorrhea method is effective for six months after childbirth and can be used by amenorrheic woman who is exclusively breastfeeding.

<sup>1</sup> Maternal Mortality ratio was 529/100,000 live births in TDHS 1996

<sup>2</sup> Pile, J. M., and Simbakalia, C. 2006. *Repositioning family planning—Tanzania case study: A successful program loses momentum*. New York: EngenderHealth/The ACQUIRE Project.





## **CHAPTER 7:**

# **ORAL CONTRACEPTIVES**

### **Overview**

This chapter covers information and procedures related to the provision of oral contraceptives, including combined oral contraceptives (COCs), progestin-only pills (POPs) and emergency contraceptive pills (ECPs).

Key topics to be covered for each method include general information as well as processes and procedural steps to follow for safe and effective provision of oral contraceptives:

- Definition
- Effectiveness
- General characteristics, including side effects and health benefits
- Information to provide clients on oral contraceptives during counselling
- How to screening for medical eligibility
- When to initiate use of method
- Management of side effects and complications

## I. Combined Oral Contraceptives (COCs)

Combined oral contraceptives (COCs) contain low doses of 2 hormones — a progestin and an estrogen—like the natural hormones progesterone and estrogen in a woman’s body. They are also called “the Pill,” low-dose combined pills, OCPs, and OCs. **Low-dose COCs** (defined as containing less than 50 micrograms of estrogen) **are highly effective and safe for healthy, non-smoking women.**

The low-dose combined estrogen-progestin COCs are one of the most popular reversible contraceptives developed to date and are used safely by over 65 million women worldwide. Most women use COCs successfully, when properly counselled regarding how to use them and what to expect in terms of side effects. **Service delivery for COCs can and should be relatively uncomplicated.**

Each packet of COCs contains 21 “active” pills that contain hormones, followed by 7 “reminder” pills of a different colour that do not contain hormones.

### Definition of Terms

<b>Regular Use</b>	Taking hormonal pills for three weeks with a hormone-free interval of one week (when the woman either takes pills that contain no hormones, just iron or sugar) – this is the most common regimen
<b>Extended Use</b>	when hormonal pills are taken for 12 weeks without a break, followed by a week of nonhormonal pills (less common than regular use)
<b>Continuous Use</b>	when hormonal pills are taken without a nonhormonal break at all (not common)
<b>Perfect use</b>	If method always used consistently and correctly, without mistakes
<b>Typical use</b>	As commonly used, i.e., when pill-taking mistakes are made. (This is not uncommon, as “humans are imperfect”)

### Advance Preparation

#### Supplies

- Samples of COCs and condoms
- RCH No. 5: Family Planning Card
- Client Take Home Card
- Calendar for return dates

## 1. Providing Clients with Specific Information About COCs

Use the following guide and information to explain to the client about COC to enable them to make an informed choice.

<p><b>What are COCs?</b></p>	<ul style="list-style-type: none"> <li>• COCs are pills that contain low doses of two hormones – a progestin and an oestrogen- like the natural hormones progesterone and oestrogen in a woman’s body.</li> <li>• COCs are also called “the Pill”, low dose combined pills, Oral Contraceptive Pills and Oral Contraceptives.</li> </ul>
<p><b>Mechanism of Action of COCs</b></p>	<ul style="list-style-type: none"> <li>• COCs work primarily by preventing the egg from maturing and getting released, i.e., by preventing ovulation. COCs also thicken cervical mucus, which makes it difficult for sperm to pass through.</li> </ul>
<p><b>Effectiveness and factors that promote effectiveness</b></p>	<ul style="list-style-type: none"> <li>• Effectiveness depends on the user’s ability to take pills correctly</li> <li>• When used perfectly, COCs are more than 99% effective - less than 1 pregnancy occurs per 100 women using COCs over the first year (3 per 1000 women)</li> <li>• As commonly used, COCs are 92% effective - about 8 pregnancies occur per 100 women over the first year. This means that 92 of every 100 women using COCs will not become pregnant in the first year of use (that is, 8 of 100 will become pregnant).</li> <li>• The risk of pregnancy is greatest when a woman starts a new pill pack 3 or more days late, or misses 3 or more pills near the beginning or end of a pill pack.</li> </ul>
<p><b>Characteristics of COCs</b></p> <p><b>Advantages:</b></p>	<ul style="list-style-type: none"> <li>• Highly effective when taken correctly</li> <li>• Safe</li> <li>• Can be stopped any time without provider’s help</li> <li>• Quick return to fertility when COCs are discontinued</li> <li>• Are controlled by woman</li> <li>• Do not interfere with sex</li> <li>• Have known <b>health benefits</b>, including:             <ul style="list-style-type: none"> <li>– Protection against endometrial cancer, ovarian cancer and symptomatic pelvic inflammatory disease</li> <li>– Possible protection from ovarian cysts and iron-deficiency anaemia</li> <li>– Reduction of menstrual cramps and bleeding problems, symptoms of polycystic ovarian syndrome(irregular bleeding, acne, excess hair on face or body), and symptoms of endometriosis (pelvic pain, irregular bleeding)</li> </ul> </li> </ul>

<p><b>Disadvantages:</b></p>	<ul style="list-style-type: none"> <li>• Requires daily taking of pills</li> <li>• Have common side effects (usually diminish after 3 months of COC use): <ul style="list-style-type: none"> <li>– Changes in bleeding patterns, such as lighter bleeding, irregular bleeding, infrequent bleeding or no monthly bleeding</li> <li>– Headaches, dizziness</li> <li>– Nausea</li> <li>– Breast tenderness</li> <li>– Weight change</li> <li>– Mood change</li> </ul> </li> <li>• Serious complications, while very rare, may occur <ul style="list-style-type: none"> <li>– Blood clot in deep veins of legs can develop (deep vein thrombosis or pulmonary embolism)</li> <li>– Stroke or heart attack (extremely rare)</li> </ul> </li> <li>• Other possible physical changes: Blood pressure may increase a few points (mm Hg). When this increase is due to COCs, blood pressure declines quickly after use of COCs stops.</li> <li>• COCs offer no protection from STIs, including HIV</li> </ul>
<p><b>Correcting misunderstandings about COCs</b></p>	<ul style="list-style-type: none"> <li>• Do not build up in a woman’s body. Women do not need a “rest” from taking COCs.</li> <li>• Must be taken every day, whether or not a woman has sex that day.</li> <li>• Do not make women infertile.</li> <li>• Do not cause birth defects or multiple births.</li> <li>• Do not change women’s sexual behaviour.</li> <li>• Do not collect in the stomach. Instead, the pill dissolves each day.</li> <li>• Do not disrupt an existing pregnancy.</li> </ul>
<p><b>Who can use COCs?</b></p>	<ul style="list-style-type: none"> <li>• Nearly all women can use COCs safely and effectively, including women who: have or have not had children;</li> <li>• Are not married; are of any age, including adolescents and women over 40 years old;</li> <li>• Have just had an abortion or miscarriage;</li> <li>• Post partum women more than 21 days not breastfeeding</li> <li>• Women with heavy, long or irregular periods</li> <li>• Have anemia (now or in the past);</li> <li>• Have varicose</li> <li>• Women who may benefit from COC use such as those with uterine fibroids, breast masses which are not cancer varicose veins;</li> <li>• Are infected with HIV, whether or not on antiretroviral therapy.</li> </ul>

<b>Who cannot use COCs?</b>	<ul style="list-style-type: none"> <li>• Breastfeeding women within 6 months post partum</li> <li>• Women within the first three weeks after delivery (regardless of the breastfeeding status)</li> <li>• Smoking woman and aged 35 years or more and smokes over 15 cigarettes daily</li> <li>• Women with suspected pregnancy</li> <li>• Women with breast cancer, current or past</li> <li>• Women with liver tumours, active liver diseases, or severe cirrhosis</li> <li>• Women with blood pressure 140/90 or higher</li> <li>• Women with complicated diabetes or with diabetes of &gt;20 years duration</li> <li>• Women with gall-bladder disease</li> <li>• Women with current or history of heart attack, stroke or deep venous thrombosis (DVT)/pulmonary embolism (PE)</li> <li>• Women with migraines with aura at any age, or migraines without aura, but is age 35 or older</li> <li>• Women due for major surgery with prolonged immobilization</li> <li>• Women who are taking rifampicin and certain anticonvulsants e.g. Phenytoin, Carbamazepine, Barbiturates, Primidone, Topiramate, Oxcarbazepine</li> <li>• Has migraine headaches with blurred vision, with aura</li> </ul>
<b>Prevention of STI/HIV/AIDS</b>	<ul style="list-style-type: none"> <li>• COCs do not offer dual protection. They do protect from infection with an STI and HIV/AIDS.</li> </ul>

## 2. Screening for Medical Eligibility for COCs

After a woman has made her informed choice on her preferred method, screening for medical eligibility for the particular chosen method follows.

To screen if the woman can safely and effectively use her method of choice, the provider should ask the client the questions below following the medical eligibility criteria about their known medical conditions. Examinations and tests are not necessary.

***If she answers NO to all of the questions, then she can start COCs if she wants. If she answers YES to any question, follow the instructions specified under each question. In some cases she can still start COCs.***

- **Are you breastfeeding a baby less than 6 months old?**

No       Yes

If YES, give her COCs and tell her to start taking them 6 months after giving birth or when breast milk is no longer the baby's main food—whichever comes first

- **Have you had a baby in the last 3 weeks that you are not breastfeeding?**

No       Yes

If YES, give her COCs now and tell her to start taking them 3 weeks after childbirth

- **Do you smoke cigarettes?**

No       Yes

If she is 35 years of age or older and smokes, do not provide COCs. Urge her to stop smoking and help her choose another method.

- **Do you have cirrhosis of the liver, a liver infection, or liver tumour? (Check if her eyes or skin unusually yellow, which are signs of jaundice) Have you ever had jaundice when using COCs?**

No       Yes

If she reports serious active liver disease (jaundice, active hepatitis, severe cirrhosis, liver tumour) or ever had jaundice while using COCs, do not provide COCs. Help her choose a method without hormones.

- **Do you have high blood pressure?**

No       Yes

If you cannot check blood pressure and she reports a history of high blood pressure, or if she is being treated for high blood pressure, do not provide COCs. Refer her for a blood pressure check if possible or help her choose a method without oestrogen.

Check blood pressure if possible:

- If her blood pressure is below 140/90 mm Hg, provide COCs.
- If her systolic blood pressure is 140 mm Hg or higher or diastolic blood pressure is 90 or higher, do not provide COCs. Help her choose a method without oestrogen, but not progestin-only Injectables if systolic blood pressure is 160 or higher or diastolic pressure is 100 or higher.

*(One blood pressure reading in the range of 140–159/90–99 mm Hg is not enough to diagnose high blood pressure. Give her a backup method\* to use until she can return for another blood pressure check, or help her choose another method now if she prefers. If her blood pressure at next check is below 140/90, she can use COCs.)*

- **Have you had diabetes for more than 20 years or damage to your arteries, vision, kidneys, or nervous system caused by diabetes?**

No       Yes

If YES, do not provide COCs. Help her choose a method without oestrogen but not progestin-only injectable.

- **Do you have gallbladder disease now or take medication for gallbladder disease?**

No       Yes

If YES, do not provide COCs. Help her choose another method

- **Have you ever had a stroke, blood clot in your legs or lungs, heart attack, or other serious heart problems?**

No       Yes

If she reports heart attack, heart disease due to blocked or narrowed arteries, or stroke, do not provide COCs. Help her choose a method without oestrogen but not progestin-only injectable. If she reports a current blood clot in the deep veins of the legs or lungs (not superficial clots), help her choose a method without hormones.

- **Do you have or have you ever had breast cancer?**

No       Yes

If YES, do not provide COCs. Help her choose a method without hormones

- **Do you sometimes see a bright area of lost vision in the eye before a very bad headache (migraine aura)? Do you get throbbing, severe head pain, often on one side of the head, that can last from a few hours to several days and can cause nausea or vomiting (migraine headaches)? Such headaches are often made worse by light, noise, or moving about.**

No       Yes

If she has migraine aura at any age, do not provide COCs. If she has migraine headaches *without* aura *and* is age 35 or older, do not provide COCs. Help these women choose a method without oestrogen. If she is under 35 and has migraine headaches without aura, she can use COCs

- **Are you taking medications for seizures? Are you taking rifampicin for tuberculosis or other illness?**

No       Yes

If she is taking barbiturates, carbamazepine, oxcarbazepine, phenytoin, primidone, topiramate, or rifampicin, do not provide COCs. They can make COCs less effective. Help her choose another method but not progestin-only pills or implants.

- **Are you planning major surgery that will keep you from walking for one week or more?**

No       Yes

If YES, she can start COCs 2 weeks after the surgery. Until she can start COCs, she should use a backup method.

- **Do you have several conditions that could increase your chances of heart disease (coronary artery disease) or stroke, such as older age, smoking, high blood pressure, or diabetes?**

No       Yes

If YES, do not provide COCs. Help her choose a method without estrogen but not progestin-only injectable.

***\* Backup methods include abstinence, male and female condoms, and withdrawal. Tell her that withdrawal is the least effective contraceptive method. If possible, give her condoms.***

## Essential Information about Medical Eligibility for COCs.

Nearly all women can use COCs safely and effectively, including women who:

- Have or have not had children
- Are not married
- Are of any age, including adolescents and women over 40 years old
- Have just had an abortion or miscarriage
- Smoke cigarettes—if under 35 years old
- Have anemia now or had in the past
- Have varicose veins
- Are infected with HIV, whether or not on antiretroviral therapy (see section on Use of COCs for Women with HIV)

Women can begin using COCs:

- Without a pelvic examination
- Without any blood tests or other routine laboratory tests
- Without cervical cancer screening
- Without a breast examination
- Even when a woman is not having monthly bleeding at the time, if it is reasonably certain she is not pregnant (see Pregnancy Checklist)

Few women with certain medical conditions should not use COCs as described in the section above *“Providing Clients with Specific Information About COCs”*.

## Use of COCs for Women with HIV

- Women who are infected with HIV or have AIDS can safely use COCs.
- Women with AIDS, who take antiretroviral drugs (ARVs), other than ritonavir, can generally use COCs. (There is some evidence that ritonavir reduces the blood levels of contraceptive hormones to a much greater extent than other ARV drugs).
- Women with HIV who choose to use COCs should be counselled about dual method use and consider using condoms in addition to COCs. In addition to preventing the spread of HIV, condoms may be especially beneficial to women on ARVs because condoms provide additional protection from pregnancy in the event that COC effectiveness is reduced by ARVs.

## 3. Providing Combined Oral Contraceptives

- After determining that the client can safely and effectively use COCs, what follows is the provision of the COCs to the woman which involves the following procedure steps:
  - (a) Determine when she can begin using COCs.
  - (b) Explain how she should use COCs, including providing her with information on what to do if she misses to take her pills.
  - (c) Explain to the client what to do if she experience side effects
  - (d) Plan for her next visit.



### 3a. Determine when she can begin using COCs

Inform the woman that she can start using COCs any time she wants if it is reasonably certain she is not pregnant. To be reasonably certain she is not pregnant, use the Pregnancy Checklist (present in section xx). Also, a woman can be given COCs at any time and told when to start taking them.

Below is additional guidance to be used for certain women depending on their status, as follows:

Woman's Status	When to Initiate
<b>Having menstrual cycles or switching from a nonhormonal method</b>	<ul style="list-style-type: none"> <li>Any time of the month</li> <li>If she is starting within 5 days after the start of her monthly bleeding, no need for a backup method.</li> <li>If it is more than 5 days after the start of her monthly bleeding, she can start COCs any time it is reasonably certain she is not pregnant. She will need a backup method for the first 7 days of taking pills. (If you cannot be reasonably certain, give her COCs now and tell her to start taking them during her next monthly bleeding.)</li> <li>If she is switching from an IUD, she can start COCs immediately</li> </ul>
<b>Switching from a hormonal method</b>	<ul style="list-style-type: none"> <li>Immediately, if she has been using the hormonal method consistently and correctly or if it is otherwise reasonably certain she is not pregnant. No need to wait for her next monthly bleeding. No need for a backup method.</li> <li>If she is switching from injectable, she can begin taking COCs when the repeat injection would have been given. No need for a backup method.</li> </ul>
<b>Breastfeeding, less than 6 months after giving birth</b>	<ul style="list-style-type: none"> <li>Give her COCs and tell her to start taking them 6 months after giving birth or when breast milk is no longer the baby's main food—whichever comes first.</li> </ul>
<b>Breastfeeding, more than 6 months after giving birth</b>	<ul style="list-style-type: none"> <li>If her monthly bleeding has not returned, she can start COCs any time it is reasonably certain she is not pregnant. She will need a backup method for the first 7 days of taking pills. (If you cannot be reasonably certain, give her COCs now and tell her to start taking them during her next monthly bleeding.)</li> <li>If her monthly bleeding has returned, she can start COCs as advised for women having menstrual cycles or switching from a non hormonal method).</li> </ul>
<b>Not breastfeeding, less than 4 weeks after giving birth</b>	<ul style="list-style-type: none"> <li>She can start COCs at any time on days 21–28 after giving birth. Give her pills any time to start during these 7 days. No need for a backup method.</li> </ul>

<b>Not breastfeeding, more than 4 weeks after giving birth</b>	<ul style="list-style-type: none"> <li>• If her monthly bleeding has not returned, she can start COCs any time if it is reasonably certain she is not pregnant.*</li> <li>• She will need a backup method for the first 7 days of taking pills. (If you cannot be reasonably certain, give her COCs now and tell her to start taking them during her next monthly bleeding.)</li> <li>• If her monthly bleeding has returned, she can start COCs as advised for women having menstrual cycles</li> </ul>
<b>No monthly bleeding</b> (not related to childbirth or breastfeeding)	<ul style="list-style-type: none"> <li>• She can start COCs any time if it is reasonably certain she is not pregnant. She will need a backup method for the first 7 days of taking pills.</li> </ul>
<b>After miscarriage or abortion</b>	<ul style="list-style-type: none"> <li>• Immediately. If she is starting within 5 days after first- or second-trimester miscarriage or abortion, no need for a backup method.</li> <li>• If it is more than 5 days after first- or second trimester miscarriage or abortion, she can start COCs any time if it is reasonably certain she is not pregnant. She will need a backup method for the first 7 days of taking pills. (If you cannot be reasonably certain, give her COCs now and tell her to start taking them during her next monthly bleeding.)</li> </ul>
<b>After taking emergency contraceptive pills (ECPs)</b>	<ul style="list-style-type: none"> <li>• She can start COCs the day after she finishes taking the ECPs. There is no need to wait for her next monthly bleeding to start her pills.</li> <li>• A new COC user should begin a new pill pack.</li> <li>• A continuing user who needed ECPs due to pill-taking errors can continue where she left off with her current pack.</li> <li>• All women will need to use a backup method for the first 7 days of taking pills.</li> </ul>

*\*Where a 6 weeks visit after childbirth is routinely recommended and other opportunities to obtain contraception are limited, some providers and programs may give COCs at the 6-week visit, without further evidence that the woman is not pregnant, if her monthly bleeding has not yet returned*

### 3b. Explain how she should use COCs

- **Explain the following information to the client on how she should use COCs.**

<b>Review client's understanding of the method</b>	<ul style="list-style-type: none"> <li>• Review discussions from counseling for informed choice, findings from the history taken and confirmation of medical eligibility for chosen method as applicable.</li> </ul>
<b>Explain pill pack</b>	<ul style="list-style-type: none"> <li>• Show which kind of pack – 28 pills. Point out that the last 7 pills are different colour and do not contain hormones.</li> <li>• Show how to take the first pill from the pack and then how to follow the directions or arrows on the pack to take the rest of the pills.</li> </ul>

<b>Instruct client on use of COCs</b>	<ul style="list-style-type: none"> <li>• <b>Take one pill each day</b>—until the pack is empty.</li> <li>• Discuss cues for taking a pill every day. Linking pill-taking to a daily activity—such as cleaning her teeth—may help her remember.</li> <li>• Taking pills at the same time each day helps to remember them. It also may help reduce some side effects.</li> </ul>
<b>Explain starting the next pack/sachet</b>	<ul style="list-style-type: none"> <li>• 28-pill packs: When she finishes one pack, she should take the first pill from the next pack on the very next day.</li> <li>• It is very important to start the next pack/sachet on time. Starting a pack late risks pregnancy.</li> </ul>
<b>Provide backup method and explain use (If one or more pills are missed)</b>	<ul style="list-style-type: none"> <li>• Sometimes she may need to use a backup method, such as when she misses pills.</li> <li>• Backup methods include abstinence, male or female condoms, and withdrawal. Tell her that withdrawal is the least effective contraceptive methods. Give her condoms, if possible</li> </ul>
<b>Ensure client has understood the information discussed</b>	<ul style="list-style-type: none"> <li>• Encourage the client to ask questions and respond in non technical language and accurately.</li> <li>• Allow her to repeat in brief, what she has learned about the use of the COCs.</li> <li>• Commend and add omitted information.</li> </ul>
<b>Give the Pills</b>	<ul style="list-style-type: none"> <li>• Issue three to thirteen cycles depending on the woman'</li> <li>• Inform client to return any time if she has concern</li> <li>• Record the number of cycles issued in the client's RCH No. 5: Family Planning Card and HMIS book No.8</li> </ul>

• **Explain if to the client what to do if she forgets one or more Pills:**

It is easy to forget a pill or to be late in taking it. COC users should know what to do if they forget to take pills. **If a woman misses one or more pills, she should follow the instructions below.**

<b>Key message to client</b>	<ul style="list-style-type: none"> <li>• Take a missed hormonal pill as soon as possible.</li> <li>• Keep taking pills as usual, one each day. (She may take 2 pills at the same time or on the same day.)</li> </ul>
<b>Missed 1 or 2 pills or started new pack 1 or 2 days late?</b>	<ul style="list-style-type: none"> <li>• Take a hormonal pill as soon as possible.</li> <li>• Little or no risk of pregnancy.</li> </ul>
<b>Missed 3 or more pills in the first or second week?</b>	<ul style="list-style-type: none"> <li>• Take a hormonal pill as soon as possible</li> <li>• Use a backup method for the next 7 days.</li> </ul>
<b>Started new pack 3 or more days late?</b>	<ul style="list-style-type: none"> <li>• Also, if she had sex in the past 5 days, can consider ECPs.</li> </ul>

<b>Missed 3 or more pills in the third week?</b>	<ul style="list-style-type: none"> <li>• Take a hormonal pill as soon as possible.</li> <li>• Finish all hormonal pills in the pack. Throw away the 7 nonhormonal pills in a 28-pill pack.</li> <li>• Start a new pack the next day</li> <li>• Use a backup method for the next 7 days.</li> <li>• Also, if she had sex in the past 5 days, can consider ECPs</li> </ul>
<b>Missed any nonhormonal pills?</b> (last 7 pills in 28-pill pack)	<ul style="list-style-type: none"> <li>• Discard the missed nonhormonal pill(s).</li> <li>• Keep taking COCs, one each day. Start the new pack as usual.</li> </ul>
<b>Severe vomiting or diarrhoea</b>	<ul style="list-style-type: none"> <li>• If she vomits within 2 hours after taking a pill, she should take another pill from her pack as soon as possible, then keep taking pills as usual.</li> <li>• If she has vomiting or diarrhoea for more than 2 days, follow instructions for 1 or 2 missed pills, above.</li> </ul>

### 3c. Explain to the client what to do if she experience side effects

Thorough counseling about bleeding changes and other side effects is an important part of providing the method. Counseling about bleeding changes may be the most important help a woman needs to keep using the method.

<b>Describe the most common side effects</b>	<ul style="list-style-type: none"> <li>• In the first few months, bleeding at unexpected times (irregular bleeding). Then lighter, shorter, and more regular monthly bleeding.</li> <li>• Headaches, breast tenderness, weight change, and possibly other side effects.</li> </ul>
<b>Explain about these side effects</b>	<ul style="list-style-type: none"> <li>• Side effects are not signs of illness.</li> <li>• Most side effects usually become less or stop within the first few months of using COCs.</li> <li>• Common, but some women do not have them.</li> </ul>
<b>Explain what to do in case of side effects</b>	<ul style="list-style-type: none"> <li>• Keep taking COCs. Skipping pills risks pregnancy and can make some side effects worse.</li> <li>• Take each pill at the same time every day to help reduce irregular bleeding and also help with remembering.</li> <li>• Take pills with food or at bedtime to help avoid nausea.</li> <li>• The client can come back for help if side effects bother her.</li> </ul>

### 3d. Plan for her next visit

- Encourage her to come back for more pills before she uses up her supply of pills. A visit after three months or more is recommended. This offers an opportunity to answer any questions, help with any problems, and check on correct use.
- Assure every client that she is welcome to come back any time—for example, if she has problems, questions, or wants another method; she has any major change in health status; or she thinks she might be pregnant.

#### 4. Helping Continuing Users

- Review the client’s family planning card for findings on client’s previous visits.
- Ask how the client is doing with the method and whether she is satisfied. Ask if she has any questions or anything to discuss.
- Ask especially if she is concerned about bleeding changes. Give her any information or help that she needs.
- Ask if she often has problems remembering to take a pill every day. If so, discuss ways to remember, making up missed pills, and ECPs, or choosing another method.
- **Give her more pill packs**—a full year supply (13 packs) depending on the woman’s health status. **Plan her next resupply** visit before she will need more pills.
- Every year or so check blood pressure if possible
- Ask a long-term client if she has had any new health problems since her last visit. Address problems as appropriate.
- Ask a long-term client about major life changes that may affect her needs—particularly plans for having children and STI/HIV risk. Follow up as needed.

#### 5. Managing any problems related to COC

- Use the **Subjective Objective Assessment Plan (SOAP)** approach to take history from client to identify the client’s major concern/problem and manage problems presented by clients.
- Discuss the problem with the client.
- Share findings with the client and discuss your plan. Manage the client’s problem according to the identified problem.

The SOAP approach helps the provider to effectively manage the client problem(s) so the client will get appropriate management. It avoids missed opportunities. It is systematic and easy to follow. It consists of four components explained below.

Component	Actions	Skills Required
<b>Subjective</b> This is information the client describes on what happened or how she is feeling (e.g. lower abdominal pain). It comes out if the/provider asks open-ended questions, shows care, concern and listens actively in privacy and confidentiality is assured. Most of the time, subjective information through history taking is sufficient to assist the provider to manage the problem.	- History taking.	- Listen.
<b>Objective</b> This is information the provider gets from conducting a clinical assessment of the client. For clients presenting with warning signs for COCs, such as chest pain, sharp abdominal pain, severe headache, blurred vision, the provider should examine the client according to usual clinical guidelines.	Examination and investigations	- Look, Feel, Test.

<p><b>Assessment</b> This is the service provider's impression on the possible causes of the client's problem after looking at the subjective information and/or objective findings (e.g. assessment can be STI, PID etc.)</p>	<ul style="list-style-type: none"> <li>- Review findings, reach conclusions.</li> <li>- Share findings.</li> <li>- Explain next steps.</li> </ul>	<ul style="list-style-type: none"> <li>- Analyse, Interpret, Diagnose.</li> </ul>
<p><b>Plan</b> This refers to the plan the service provider develops to manage the findings. Depending on the assessment findings, the problem may require switching to another method (e.g. if woman developed migraines with aura or other condition incompatible with safe use of COCs), or requires additional counseling and reassurance (e.g. one of the common side effects of COCs).</p>	<ul style="list-style-type: none"> <li>- Manage problem.</li> <li>- Share management plan for return visits.</li> </ul>	<ul style="list-style-type: none"> <li>- Treat Continuity Follow-up.</li> </ul>

### Problems reported as side effects or problems with use

- Some clients using COCs may experience side effects which may or may not be due to the method. Problems with side effects affect women's satisfaction and use of COCs. They deserve the provider's attention. If the client reports side effects or problems, listen to her concerns, give her advice, and, if appropriate, treat.
- Encourage her to keep taking a pill every day even if she has side effects. Missing pills can risk pregnancy and may make some side effects worse (e.g. breakthrough bleeding).
- Many side effects will subside after a few months of use. If side effects persist and woman finds them bothersome, give her a different COC formulation, if available.
- Offer to help the client choose another method—now, if she wishes, or if problems cannot be overcome.

### Side Effects related to COC Use

**Irregular bleeding** (bleeding at unexpected times that bothers the client)

- Reassure her that many women using COCs experience irregular bleeding. It is not harmful and usually becomes less or stops after the first few months of use.
- Other possible causes of irregular bleeding include:
  - Missed pills
  - Taking pills at different times every day
  - Vomiting or diarrhea
  - Taking anticonvulsants or rifampicin (see [Starting treatment with anticonvulsants or rifampicin](#))
- To reduce irregular bleeding:
  - Urge her to take a pill each day and at the same time each day.
  - Teach her to make up for missed pills properly, including after vomiting or diarrhea (see [Managing Missed Pills](#)).
  - For modest short-term relief, she can try 800 mg ibuprofen 3 times daily after meals for 5 days or other nonsteroidal anti-inflammatory drug (NSAID), beginning when irregular bleeding starts. NSAIDs provide some relief of irregular bleeding for implants, progestin-only injectables, and IUDs, and they may also help for COCs.

- If she has been taking the pills for more than a few months and NSAIDs do not help, give her a different COC formulation, if available. Ask her to try the new pills for at least 3 months.
- If irregular bleeding continues or starts after several months of normal or no monthly bleeding, or you suspect that something may be wrong for other reasons, consider underlying conditions unrelated to method use (see [Unexplained vaginal bleeding](#)).

### No monthly bleeding

- Ask if she is having any bleeding at all. (She may have just a small stain on her underclothing and not recognize it as monthly bleeding.) If she is, reassure her.
- Reassure her that some women using COCs stop having monthly bleeding, and this is not harmful. There is no need to lose blood every month. It is similar to not having monthly bleeding during pregnancy. She is not infertile. Blood is not building up inside her. (Some women are happy to be free from monthly bleeding.)
- Ask if she has been taking a pill every day. If so, reassure her that she is not likely to be pregnant. She can continue taking her COCs as before.
- Did she skip the 7-day break between packs (21-day packs) or skip the 7 nonhormonal pills (28-day pack)? If so, reassure her that she is not pregnant. She can continue using COCs.
- If she has missed hormonal pills or started a new pack late:
  - She can continue using COCs.
  - Tell a woman who has missed 3 or more pills or started a new pack 3 or more days late to return if she has signs and symptoms of early pregnancy (see common [Signs and Symptoms of Pregnancy](#)).
  - See instructions on [how to make up for missed pills](#).

### Ordinary headaches (nonmigrainous)

- Try the following (one at a time):
  - Suggest aspirin (325–650 mg), ibuprofen (200–400 mg), paracetamol (325–1000 mg), or other pain reliever.
  - Some women get headaches during the hormone-free week (the 7 days a woman does not take hormonal pills). Consider extended use (see [Extended and Continuous Use of Combined Oral Contraceptives](#)).
- Any headaches that get worse or occur more often during COC use should be evaluated.

### Nausea or dizziness

- For nausea, suggest taking COCs at bedtime or with food.

If symptoms continue:

- Consider locally available remedies.
- Consider extended use if her nausea comes after she starts a new pill pack (see [Extended and Continuous Use of Combined Oral Contraceptives](#)).

## Breast tenderness

- Recommend that she wear a supportive bra (including during strenuous activity and sleep).
- Try hot or cold compresses.
- Suggest aspirin (325–650 mg), ibuprofen (200–400 mg), paracetamol (325–1000 mg), or other pain reliever.
- Consider locally available remedies.

## Weight change

- Review diet and counsel as needed.

## Mood changes or changes in sex drive

- Some women have changes in mood during the hormone-free week (the 7 days when a woman does not take hormonal pills). Consider extended use (see [Extended and Continuous Use of Combined Oral Contraceptives](#)).
- Ask about changes in her life that could affect her mood or sex drive, including changes in her relationship with her partner. Give her support as appropriate.
- Clients who have serious mood changes such as major depression should be referred for care.
- Consider locally available remedies.

## Acne

- Acne usually improves with COC use. It may worsen for a few women.
- If she has been taking pills for more than a few months and acne persists, give her a different COC formulation, if available. Ask her to try the new pills for at least 3 months.
- Consider locally available remedies.

## New Problems That May Require Switching Methods

Some clients using COCs may experience side effects which may or may not be due to the method. Hence it is important to assess the client's problem effectively, as follows:

### **Unexplained vaginal bleeding** (that suggests a medical condition not related to the method) **or heavy or prolonged bleeding**

- Refer or evaluate by history and pelvic examination. Diagnose and treat as appropriate.
- She can continue using COCs while her condition is being evaluated.
- If bleeding is caused by sexually transmitted infection or pelvic inflammatory disease, she can continue using COCs during treatment.
- If there is no underlying medical condition and woman finds bleeding unacceptable, help her choose another method (non-hormonal).



## Starting treatment with anticonvulsants or rifampicin

- Barbiturates, carbamazepine, oxcarbazepine, phenytoin, primidone, topiramate, and rifampicin may make COCs less effective. If using these medications long-term, she may want a different method, such as progestin-only injectable, or a copper-bearing IUD.
- If using these medications short-term, she can use a backup method along with COCs.

## Migraine headaches

- Regardless of her age, a woman who develops migraine headaches, with or without aura, or whose migraine headaches become worse while using COCs should stop using COCs.
- Help her choose a method without oestrogen.

## Circumstances that will keep her from walking for one week or more

- If she is having major surgery, or her leg is in a cast, or for other reasons she will be unable to move about for several weeks, she should:
  - Tell her doctors that she is using COCs.
  - Stop taking COCs and use a backup method during this period.
  - Restart COCs 2 weeks after she can move about again.

## II. Progestin-Only Pills (POPs)

Progestin-only pills (POPs) contain a very small amount of only one kind of hormone, progestin. POPs contain one-half to one-tenth as much progestin as COCs. They do not contain estrogen and are best suited for breastfeeding women as they do not reduce quantity of milk. POPs are also more effective in breastfeeding women because of the additional protective effect of the lactational amenorrhea. Women who are not breastfeeding should adhere to a very strict POP schedule – delaying the next pill by as little as 3 hours may lead to ovulation and subsequent pregnancy.

A number of preparations are currently available using a variety of progestins. **Progestin-only pills are taken every day with no pill-free intervals.**

## Providing specific information about POPs

### What are POPs?

- Pills that contain very low doses of a progestin like the natural hormone progesterone in a woman's body.
- Do not contain oestrogen, and so can be used throughout breastfeeding and by women who cannot use methods with oestrogen.
- Progestin-only pills (POPs) are also called “mini pills” and progestin-only oral contraceptives.

### Mechanism of action of POPs

- Work primarily by:
  - Thickening cervical mucus (this blocks sperm from meeting an egg)

- Disrupting the menstrual cycle, including preventing the release of eggs from the ovaries (ovulation)

### **Effectiveness and factors that promote effectiveness**

- Effectiveness depends on the user's ability to take pills correctly
- For women who have monthly bleeding, risk of pregnancy is greatest if pills are taken late or missed completely.

### **Breastfeeding women:**

- As commonly used, about 1 pregnancy per 100 women using POPs over the first year. This means that 99 of every 100 women will not become pregnant.
- When pills are taken every day, less than 1 pregnancy per 100 women using POPs over the first year (3 per 1,000 women).

### **Less effective for women not breastfeeding:**

- As commonly used, about 3 to 10 pregnancies per 100 women using POPs over the first year. This means that 90 to 97 of every 100 women will not become pregnant.
- When pills are taken every day at the same time, less than 1 pregnancy per 100 women using POPs over the first year (9 per 1,000 women).
- Must be taken more or less the same time everyday for it to work well (more strict pill schedule than COCs)

## **Characteristics of POPs**

### **Advantages**

- Very effective when taken correctly and in breastfeeding women
- Safe for majority of women
- Can be used while breastfeeding
- Can be stopped any time without provider's help
- Are controlled by the woman
- Do not interfere with sex
- Fertility returns as soon as woman stops taking POPs (if she is not breastfeeding)

### **Disadvantages**

- Need to remember to take on time
- Have common side effects:
  - Changes in bleeding patterns, such as frequent bleeding, irregular bleeding, infrequent bleeding, prolonged bleeding, or no monthly bleeding
  - Headaches, dizziness
  - Mood changes
  - Breast tenderness

- Abdominal pain
- Nausea
- Other possible physical changes:
  - For women not breastfeeding, enlarged ovarian follicles
- POPs offer no protection from STIs, including HIV

## Correcting misunderstandings about POPs

Progestin-only pills:

- Do not cause a breastfeeding woman's milk to dry up.
- Must be taken every day, whether or not a woman has sex that day.
- Do not make women infertile.
- Do not cause diarrhoea in breastfeeding babies.
- Reduce the risk of ectopic pregnancy.

## Screening for Medical Eligibility for POPs

Nearly all women can use POPs safely and effectively, including women who: are breastfeeding (starting as soon as 6 weeks after childbirth); have or have not had children; are not married; are of any age, including adolescents and women over 40 years old; have just had an abortion, miscarriage, or ectopic pregnancy; smoke cigarettes (regardless of the woman's age or the number of cigarettes smoked); have anemia (now or in the past); have varicose veins; are infected with HIV, whether or not on antiretroviral therapy. Women can begin using POPs: without a pelvic examination; without any blood tests or other routine laboratory tests; without cervical cancer screening; without a breast examination; and even if she is not having her monthly bleeding at the time, if it is reasonably certain she is not pregnant (see Pregnancy checklist). Few women with certain medical conditions should not use POPs. Ask the client the questions below about known medical conditions. Examinations and tests are not necessary. If she answers NO to all of the questions, then she can start POPs if she wants. If she answers YES to a question, follow the instructions. In some cases she can still start POPs.

### 1. Are you breastfeeding a baby less than 6 weeks old?

No     Yes

If YES, she can start taking POPs as soon as 6 weeks after childbirth. Give her POPs now and tell her when to start taking them

### 2. Do you have severe cirrhosis of the liver, a liver infection, or liver tumour? (Check if her eyes or skin unusually yellow, which is a sign of jaundice)

No     Yes

If she reports serious active liver disease (jaundice, active hepatitis, severe cirrhosis, liver tumour), do not provide POPs. Help her choose a method without hormones.

### 3. Do you have a serious problem now with a blood clot in your legs or lungs?

No     Yes

If she reports a current blood clot (not superficial clots), do not provide POPs. Help her choose a method without hormones.

**4. Are you taking medication for seizures? Are you taking rifampicin for tuberculosis or other illness?**

No  Yes

If she is taking barbiturates, carbamazepine, oxcarbazepine, phenytoin, primidone, topiramate, or rifampicin, do not provide POPs. **They can make POPs less effective.** Help her choose another method but not combined oral contraceptives or implants.

**5. Do you have or have you ever had breast cancer?**

No  Yes

If YES, do not provide POPs. Help her choose a method without hormones.

### Progestin-Only Pills for Women with HIV

- Women who are infected with HIV or have AIDS can safely use POPs.
- Women with AIDS, who take antiretroviral drugs (ARVs), other than ritonavir, can generally use POP. (There is some evidence that ritonavir reduces the blood levels of contraceptive hormones to a much greater extent than other ARV drugs)
- Urge these women to use condoms along with POPs. Used consistently and correctly, condoms help prevent transmission of HIV and other STIs. Condoms also provide extra contraceptive protection for women on ARV therapy.
- For appropriate breastfeeding practices for women with HIV, refer for prevention of mother to child transmission of HIV

### Providing Progestin-Only Pills

#### When to Initiate

**IMPORTANT:** A woman can start using POPs any time she wants if it is reasonably certain she is not pregnant. To be reasonably certain she is not pregnant, use the Pregnancy Checklist. Also, a woman can be given POPs at any time and told when to start taking them.

Woman's Status	When to Initiate
<b>Fully or nearly fully breastfeeding, less than 6 months after giving birth</b>	<ul style="list-style-type: none"><li>• If she gave birth less than 6 weeks ago, give her POPs and tell her to start taking them 6 weeks after giving birth.</li><li>• If her monthly bleeding has not returned, she can start POPs any time between 6 weeks and 6 months. No need for a backup method.</li><li>• If her monthly bleeding has returned, she can start POPs as advised for women having menstrual cycles.</li></ul>

<p><b>Fully or nearly fully breastfeeding, more than 6 months after giving birth</b></p> <p>Or</p> <p><b>Partially breastfeeding more than 6 weeks after giving birth</b></p> <p>Or</p> <p><b>Not breastfeeding, more than 4 weeks after giving birth</b></p>	<ul style="list-style-type: none"> <li>• If her monthly bleeding has not returned, she can start POPs any time it is reasonably certain she is not pregnant. She will need a backup method for the first 2 days of taking pills. (If you cannot be reasonably certain, give her POPs now and tell her to start taking them during her next monthly bleeding.)</li> <li>• If her monthly bleeding has returned, she can start POPs as advised for women having menstrual cycles.</li> </ul>
<p><b>Partially breastfeeding, less than 6 weeks after giving birth</b></p>	<ul style="list-style-type: none"> <li>• Give her POPs and tell her to start taking them 6 weeks after giving birth.</li> <li>• Also give her a backup method to use until 6 weeks since giving birth if her monthly bleeding returns before this time.</li> </ul>
<p><b>Not breastfeeding, less than 4 weeks after giving birth</b></p>	<ul style="list-style-type: none"> <li>• She can start POPs at any time. No need for a backup method.</li> </ul>
<p><b>Switching from a hormonal method</b></p>	<ul style="list-style-type: none"> <li>• Immediately, if she has been using the hormonal method consistently and correctly or if it is otherwise reasonably certain she is not pregnant. No need to wait for her next monthly bleeding. No need for a backup method.</li> <li>• If she is switching from injectable, she can begin taking POPs when the repeat injection would have been given. No need for a backup method.</li> </ul>
<p><b>Having menstrual cycles or switching from a nonhormonal method</b></p>	<ul style="list-style-type: none"> <li>• Any time of the month</li> <li>• If she is starting within 5 days after the start of her monthly bleeding, no need for a backup method.</li> <li>• If it is more than 5 days after the start of her monthly bleeding, she can start POPs any time it is reasonably certain she is not pregnant. She will need a backup method for the first 2 days of taking pills. (If you cannot be reasonably certain, give her POPs now and tell her to start taking them during her next monthly bleeding.)</li> <li>• If she is switching from an IUD, she can start POPs immediately</li> </ul>
<p><b>No monthly bleeding</b> (not related to childbirth or breastfeeding)</p>	<ul style="list-style-type: none"> <li>• She can start POPs any time it is reasonably certain she is not pregnant. She will need a backup method for the first 2 days of taking pills.</li> </ul>

<b>After miscarriage or abortion</b>	<ul style="list-style-type: none"> <li>• Immediately. If she is starting within 5 days after first- or second-trimester miscarriage or abortion, no need for a backup method.</li> <li>• If it is more than 5 days after first- or second trimester miscarriage or abortion, she can start POPs. Any time it is reasonably certain she is not pregnant. She will need a backup method for the first 2 days of taking pills. (If you cannot be reasonably certain, give her POPs now and tell her to start taking them during her next monthly bleeding.)</li> </ul>
<b>After taking emergency Contraceptive pills (ECPs)</b>	<ul style="list-style-type: none"> <li>• She can start POPs the day after she finishes taking the ECPs. There is no need to wait for her next monthly bleeding to start her pills.</li> <li>• A new POP user should begin a new pill pack.</li> <li>• A continuing user who needed ECPs due to pill-taking errors can continue where she left off with her current pack.</li> <li>• All women will need to use a backup method for the first 2 days of taking pills.</li> </ul>

## Explaining How to Use

<b>Review client's understanding of the method</b>	<ul style="list-style-type: none"> <li>• Review discussions from counselling for informed choice, findings from the history taken and confirmation of medical eligibility to chosen method as applicable</li> </ul>
<b>Explain pill pack</b>	<ul style="list-style-type: none"> <li>• Show which kind of pack—28 pills.</li> <li>• Explain that all pills in POP packs are the same colour and all are active pills, containing a hormone that prevents pregnancy.</li> <li>• Show how to take the first pill from the pack and then how to follow the directions or arrows on the pack to take the rest of the pills</li> </ul>
<b>Instruct client on use of POP</b>	<ul style="list-style-type: none"> <li>• Take one pill each day—until the pack is empty.</li> <li>• Discuss cues for taking a pill every day. Linking pill-taking to a daily activity—such as cleaning her teeth—may help her remember.</li> <li>• Taking pills at the same time each day helps to remember them.</li> </ul>
<b>Explain starting the next pack/sachet</b>	<ul style="list-style-type: none"> <li>• When she finishes one pack, she should take the first pill from the next pack on the very next day.</li> <li>• It is very important to start the next pack on time. Starting a pack late risks pregnancy.</li> </ul>

<p><b>Provide backup method and explain use</b> (If one or more pills are missed)</p>	<ul style="list-style-type: none"> <li>• Sometimes she may need to use a backup method, such as when she misses pills.</li> <li>• Backup methods include abstinence, male or female condoms, and withdrawal.</li> <li>• Tell her that withdrawal is the least effective contraceptive method.</li> <li>• Give her condoms, if possible.</li> </ul>
<p><b>Ensure client has understood the information discussed</b></p>	<ul style="list-style-type: none"> <li>• Encourage the client to ask questions and respond in non technical language and accurately.</li> <li>• Allow her to repeat in brief, what she has learned about the use of the POPs.</li> <li>• Commend and add omitted information.</li> </ul>
<p><b>Explain that effectiveness decreases when breastfeeding stops</b></p>	<ul style="list-style-type: none"> <li>• Without the additional protection of breastfeeding itself, POPs are not as effective as most other hormonal methods.</li> <li>• When she stops breastfeeding, she can continue taking POPs if she is satisfied with the method, or she is welcome to come back for another method.</li> </ul>
<p><b>Give the Pills</b></p>	<ul style="list-style-type: none"> <li>• Issue three to thirteen cycles depending on the health status of the woman based on the availability of POPs and woman’s desire to continue method even after she stops breastfeeding.</li> <li>• Inform client to return any time if she has concern</li> <li>• Record the cycles issued in the client’s RCH No. 5: Family Planning Card and MTUHA book No. 8</li> </ul>

## Supporting the User

### *Managing Missed Pills*

It is easy to forget a pill or to be late in taking it. POP users should know what to do if they forget to take pills. **If a woman is 3 or more hours late taking a pill or misses one completely, she should follow the instructions below.** For breastfeeding women, whether missing a pill places her at risk of pregnancy depends on whether or not her monthly bleeding has returned.

### **Making Up Missed Progestin-Only Pills**

<p><b>Key message</b></p>	<ul style="list-style-type: none"> <li>• Take a missed pill as soon as possible.</li> <li>• Keep taking pills as usual, one each day. (She may take 2 pills at the same time or on the same day.)</li> </ul>
---------------------------	--

<b>Do you have monthly bleeding regularly?</b>	<ul style="list-style-type: none"> <li>• If yes, she also should use a backup method for the next 2 days.</li> <li>• Also, if she had sex in the past 5 days, can consider taking ECPs (see Emergency Contraceptive Pills).</li> </ul>
<b>Severe vomiting or diarrhoea</b>	<ul style="list-style-type: none"> <li>• If she vomits within 2 hours after taking a pill, she should take another pill from her pack as soon as possible, and keep taking pills as usual.</li> <li>• If her vomiting or diarrhoea continues, follow the instructions for making up missed pills above.</li> </ul>

### Planning the Next Visit

- Encourage her to come back for more pills before she uses up her supply of pills.
- Contacting women after the first 3 months of POP use is recommended. This offers an opportunity to answer any questions, help with any problems, and check on correct use.

### Reasons to Return

Assure every client that she is welcome to come back any time—for example, if she has problems, questions, or wants another method; she has a major change in health status; or she thinks she might be pregnant.

Also if:

- She has stopped breastfeeding and wants to switch to another method.
- For a woman who has monthly bleeding: If she took a pill more than 3 hours late or missed one completely, and also had sex during this time, she may wish to consider ECPs

General health advice: Anyone who suddenly feels that something is seriously wrong with her health should immediately seek medical care from a nurse or doctor. Her contraceptive method is most likely not the cause of the condition, but she should tell the nurse or doctor what method she is using.

### Helping Continuing Users

- Ask how the client is doing with the method and whether she is satisfied. Ask if she has any questions or anything to discuss.
- Ask especially if she is concerned about bleeding changes. Give her any information or help that she needs
- Ask if she often has problems remembering to take a pill every day. If so, discuss ways to remember, making up for missed pills, and ECPs, or choosing another method.
- **Give her more pill packs** — as much as three cycles or six cycles to thirteen cycles if possible (and if she wants to continue with POPs after she stops breastfeeding). Plan her next resupply visit before she will need more pills.
- Ask a long-term client if she has had any new health problems since her last visit. Address problems as appropriate. Ask if the client conducts self-breast examination.
- Ask a long-term client about major life changes that may affect her needs—particularly plans for having children and STI and HIV risk.
- Follow up as needed.



## Managing Any Problems related to POP use

### Problems reported as side effects or problems with use

May or may not be due to the method.

- Problems with side effects affect women's satisfaction and use of POPs. They deserve the provider's attention. If the client reports side effects or problems, listen to her concerns, give her advice, and, if appropriate, treat.
- Encourage her to keep taking a pill every day even if she has side effects. Missing pills can risk pregnancy.
- Many side effects will subside after a few months of use. For a woman whose side effects persist, give her a different POP formulation, if available, for at least 3 months.
- Offer to help the client choose another method—now, if she wishes, or if problems cannot be overcome.

### Manage other problems according to the instructions for the following side effects:

- **Missed pills**
  - See Managing Missed Pills
- **Ordinary headaches (nonmigrainous)**
  - Suggest aspirin (325–650 mg), ibuprofen (200–400 mg), paracetamol (325–1000 mg), or other pain reliever.
  - Any headaches that get worse or occur more often during POP use should be evaluated.
- **Mood changes or changes in sex drive**
  - Ask about changes in her life that could affect her mood or sex drive, including changes in her relationship with her partner. Give her support as appropriate.
  - Some women experience depression in the year after giving birth. This is not related to POPs. Clients who have serious mood changes such as major depression should be referred for care.
  - Consider locally available remedies.
- **Nausea or dizziness**
  - For nausea, suggest taking POPs at bedtime or with food.

If symptoms continue, consider locally available remedies.

### New problems that may require switching methods

May or may not be due to the method.

**Unexplained vaginal bleeding** (that suggests a medical condition not related to the method)

- Refer or evaluate by history and pelvic examination. Diagnose and treat as appropriate.
- She can continue using POPs while her condition is being evaluated.
- If bleeding is caused by a sexually transmitted infection or pelvic inflammatory disease, she can continue using POPs during treatment.

- If there is no serious underlying condition, but woman finds bleeding unacceptable, help her choose another method (non-hormonal)

### **Starting treatment with anticonvulsants or rifampicin**

- Barbiturates, carbamazepine, oxcarbazepine, phenytoin, primidone, topiramate, and rifampicin may make POPs less effective. If using these medications long-term, she may want a different method, such as progestin-only injectable, or a copper-bearing or hormonal IUD.
- If using these medications short-term, she can use a backup method along with POPs.

### **Migraine Headaches**

- If she has migraine headaches without aura, she can continue to use POPs if she wishes.
- If she has migraine aura, stop POPs. Help her choose a method without hormones.

### **Certain serious health conditions (suspected blood clots in deep veins of legs or lungs, liver disease, or breast cancer)**

- Tell her to stop taking POPs.
- Give her a backup method to use until the condition is evaluated.
- Refer for diagnosis and care if not already under care.

### **Heart disease due to blocked or narrowed arteries (ischemic heart disease) or stroke**

- A woman who has one of these conditions can safely start POPs. If, however, the condition develops after she starts using POPs, she should stop. Help her choose a method without hormones.
- Refer for diagnosis and care if not already under care.

### **Suspected pregnancy**

- Assess for pregnancy, including ectopic pregnancy.
- Tell her to stop taking POPs if pregnancy is confirmed.
- There are no known risks to a foetus conceived while a woman is taking POPs

## **III. Emergency Contraceptive Pills (ECPs)**

Despite the availability of highly effective methods of contraception, many pregnancies are unplanned and unwanted. These pregnancies carry a higher risk of morbidity and mortality, often due to unsafe abortion. Many of these unplanned pregnancies can be avoided using emergency contraception.

Emergency contraceptive pills (ECPs) are hormonal method of contraception that can be used to prevent pregnancy following an unprotected act of sexual intercourse.

ECPs are sometimes referred to as “morning-after” or “post-coital” pills. These terms have been replaced by the term “emergency contraceptive pills” because they do not accurately convey the correct timing of use (ECPs can be used up to five days following unprotected intercourse), and because they do not convey the important message that ECPs should not be used regularly (they are intended for “emergency” use only).

## What are ECPs?

- Pills that contain a progestin alone, or a progestin and an oestrogen together—hormones like the natural hormones progesterone and oestrogen in a woman’s body.
- ECPs help to prevent pregnancy when taken up to 5 days after unprotected sex. The sooner they are taken, the better (i.e., the more effective they are)

## Mechanism of action of ECPs

- ECPs work primarily by preventing or delaying the release of eggs from the ovaries (ovulation). They do not work if a woman is already pregnant

## Effectiveness of ECPs

If 100 women each had unprotected sex once during the second or third week of the menstrual cycle				
100 women	⇒	No ECP	⇒	8 Pregnancies
100 women	⇒	Progestin-only ECPs	⇒	1 Pregnancies
100 women	⇒	Combined ECPs	⇒	2 Pregnancies

**IMPORTANT:** The sooner ECPs are taken after unprotected intercourse, the better they prevent pregnancy.

## Characteristics of ECPs

### Advantages:

- Safe for all women
- Offer a second chance to prevent pregnancy
- Have no known health risks
- Are controlled by the woman
- Return of fertility after taking ECPs: No delay. A woman can become pregnant immediately after taking ECPs. Taking ECPs prevents pregnancy only from acts of sex that took place in the 5 days before. They will not protect a woman from pregnancy from acts of sex after she takes ECPs—not even on the next day. To stay protected from pregnancy, women must begin to use another contraceptive method at once

### Disadvantages:

- Offer no protection from STIs, including HIV
- **Side Effects**
  - Changes in bleeding patterns including:
    - Slight irregular bleeding for 1–2 days after taking ECPs
    - Monthly bleeding that starts a few days earlier or later than expected

In the week after taking ECPs:

- Nausea
- Abdominal pain
- Fatigue

- Headaches
- Breast tenderness
- Dizziness
- Vomiting

### **Ensuring medical eligibility for ECPs, including in women with HIV**

All women can use ECPs safely and effectively, including women who cannot use ongoing hormonal contraceptive methods. Because of the short-term nature of their use, there are no medical conditions that make ECPs unsafe for any woman.

## **Providing Emergency Contraceptive Pills**

### **When to Initiate**

- Any time within 5 days (120 hours) after unprotected sex. The sooner after unprotected sex that ECPs are taken, the more effective they are.
- ECPs are Appropriate in Many Situations
- ECPs can be used any time a woman is worried that she might become pregnant. For example, after:
  - Forced sex (rape) or coerced
  - Any unprotected sex
  - Contraceptive mistakes, such as:
    - Condom was used incorrectly, slipped, or broke
    - Couple incorrectly used a fertility awareness based method (for example, failed to abstain or to use another method during the fertile days)
    - Man failed to withdraw, as intended, before he ejaculated
    - Woman has missed 3 or more combined oral contraceptive pills or has started a new pack 3 or more days late
    - IUD has come out of place
    - Woman is more than 4 weeks late for her repeat progestin-only injection

### **Counselling about ECPs**

As with any contraceptive method, ECPs should be provided in a manner that is respectful of the client and responsive to her needs for information and counselling. During counselling, providers should reassure all clients, regardless of age or marital status that all information will be kept confidential. Providers also should be supportive of the client's choices and refrain from making judgmental comments or indicating disapproval through body language or facial expressions while discussing ECPs with clients. Supportive attitudes will help improve compliance and set the stage for effective follow-up counselling about regular contraceptive use and sexually-transmitted disease prevention.

Whenever possible, ensure that counselling is conducted in a private and supportive environment. In situations where it is difficult to maintain privacy (for instance, in pharmacies), give the method to the client with appropriate verbal and printed instructions and advise her to attend a clinic or contact a health care/family planning provider for counselling about regular contraceptive methods.

There are a number of special issues related to counselling clients for use of ECPs:

## Stress

Clients may feel particularly anxious after unprotected intercourse due to fear of becoming pregnant, worry about missing the 120-hour window of opportunity for emergency contraception, embarrassment at failing to use a contraceptive method effectively, general embarrassment about sexual issues, rape-related trauma, concern about AIDS, or a combination of these factors. For this reason, maintaining a supportive atmosphere during counselling is especially important.

## Frequent use

Emphasize that ECPs are for emergency use only. They are not recommended for routine use because of the higher possibility of failure compared to regular contraceptives and the higher incidence of side effects.

**Note:** *Although frequent use of ECPs is not recommended, repeated use poses no health risks to users and should never be cited as a reason for denying women access to treatment.*

## HIV and STDs

Clients may be very concerned about possible infection, especially in cases of rape. Counselling on this topic should be provided along with STD diagnostic services (or referrals) and information about STD/HIV preventive measures. Clients must understand that ECPs offer no protection against STDs, including HIV/AIDS.

## Explaining how to use

<b>Give pills (pill formulation and dosage)</b>	<ul style="list-style-type: none"><li>• Progestin-only pills (POP) – 20 pills taken as soon as possible within 120 hours of unprotected intercourse and another 20 pills in 12 hours after the first dose</li><li>• Combined oral contraceptives (COCs)- low dose containing 0.03 mg of ethinyl estradiol each):<ul style="list-style-type: none"><li>– Take 4 pills as soon as possible within 120 hours of unprotected</li><li>– Take another 4 pills 12 hours after the first dose</li></ul></li><li>• When high dose COCs are used containing 0.05 mg of ethinyl estradiol each):<ul style="list-style-type: none"><li>– Take 2 pills as soon as possible within 120 hours of unprotected</li><li>– Take another 2 pills 12 hours after the first dose</li></ul></li></ul>
<b>Describe the most common side effects</b>	<ul style="list-style-type: none"><li>• Nausea, vomiting, abdominal pain, headache, breast tenderness</li><li>• Slight irregular bleeding for 1-2 days</li><li>• Next monthly bleeding starts a few days earlier or later than expected</li></ul> <p><b>Note:</b> Side effects are not signs of illness.</p>

<p><b>Explain what to do about side effects</b></p>	<ul style="list-style-type: none"> <li>• Nausea: <ul style="list-style-type: none"> <li>– Routine use of anti-nausea medications is not recommended.</li> <li>– Women who have had nausea with previous ECP use or with the first dose of a 2-dose regimen can take anti-nausea medication one-half to one hour before taking ECPs.</li> </ul> </li> <li>• Vomiting: <ul style="list-style-type: none"> <li>– If the woman vomits within 2 hours after taking ECPs, she should take another dose. (She can use anti-nausea medication with this repeat dose, as above.)</li> <li>– If vomiting continues, she can take the repeat dose by placing the pills high in her vagina.</li> <li>– If vomiting occurs more than 2 hours after taking ECPs, she does not need to take any extra pills.</li> </ul> </li> </ul>
---	--

*Women using progestin-only ECP formulations are much less likely to experience nausea and vomiting than women using oestrogen and progestin ECP formulations.*

## Supporting the User

### Planning Ongoing Contraception

1. Explain that ECPs will not protect her from pregnancy for any future sex—even the next day. Discuss the need for and choice of ongoing pregnancy prevention and, if at risk, protection from STIs including HIV.
2. If she does not want to start a contraceptive method now, give her condoms or oral contraceptives and ask her to use them if she changes her mind. Give instructions on use. Invite her to come back any time if she wants another method or has any questions or problems.
3. If possible, give her more ECPs to use in the future in case of unprotected sex.

### Reasons to Return

- No routine return visit is required. Assure every client that she is welcome to come back any time, however, and also if:
- She thinks she might be pregnant, especially if she has no monthly bleeding or her next monthly bleeding is delayed by more than one week.

## When to Initiate Contraception after ECP Use

Whenever possible, clients requesting ECPs should also be offered information and services for regular contraceptives.

Method	When to Start
<b>Combined oral contraceptives, progestin-only pills,</b>	<p>Can begin the day after she takes the ECPs. <i>No need to wait for her next monthly bleeding.</i></p> <ul style="list-style-type: none"> <li>• Oral contraceptives: <ul style="list-style-type: none"> <li>– New users should begin a new pill pack</li> <li>– A continuing user who needed ECPs due to error can resume use as before.</li> </ul> </li> <li>• All women need to use a backup method for the first 7 days of using their method.</li> </ul>
<b>Progestin-only injectable</b>	<ul style="list-style-type: none"> <li>• She can start progestin-only injectable on the same day as the ECPs, or if preferred, within 7 days after the start of her monthly bleeding. She will need a backup method for the first 7 days after the injection. She should return if she has signs or symptoms of pregnancy other than not having monthly bleeding</li> </ul>
<b>Implants</b>	<ul style="list-style-type: none"> <li>• After her monthly bleeding has returned. Give her a backup method or oral contraceptives to use until then, starting the day after she finishes taking the ECPs.</li> </ul>
<b>Intrauterine device (copper-bearing or hormonal IUDs)</b>	<ul style="list-style-type: none"> <li>• A copper-bearing IUD can be used for emergency contraception. This is a good option for a woman who wants an IUD as her long term method</li> <li>• If she decides to use an IUD after taking ECPs, the IUD can be inserted on the same day she takes the ECPs. No need for a backup method.</li> </ul>
<b>Male and Female condoms, withdrawal</b>	<ul style="list-style-type: none"> <li>• Immediately</li> </ul>
<b>Fertility Awareness Methods</b>	<ul style="list-style-type: none"> <li>• Standard Days Methods: With the start of her next monthly bleeding</li> <li>• Symptoms-based Methods: Once normal secretions have returned</li> <li>• Give her a back-up method or oral contraceptives to use until she can begin the method of her choice</li> </ul>

## Helping Users Manage any problems related to ECP use

### Problems reported as side effects or Method Failure

May or may not be due to the method

#### Slight irregular bleeding

- Irregular bleeding due to ECPs will stop without treatment.
- Assure the woman that this is not a sign of illness or pregnancy.

## **Change in timing of next monthly bleeding or suspected pregnancy**

- Monthly bleeding may start earlier or later than expected. This is not a sign of illness or pregnancy.
- If her next monthly bleeding is more than one week later than expected after taking ECPs, assess for pregnancy. There are no known risks to a foetus conceived if ECPs fail to prevent pregnancy



## **CHAPTER 8:**

# **Progestin-Only Injectable Depo Provera**

### **Overview**

This chapter covers information related to the provision of progestin-only injectable contraceptive Depo Provera, including:

- What Depo Provera is
- Effectiveness
- General characteristics, including side effects and health benefits
- Screening for medical eligibility
- When to initiate
- Management of side effects and
- Counselling issues

## Advance Preparation

- RCH No.5: Family Planning Card
- Depo Provera 150 mg vials
- Sterile disposable syringes and needles
- Leaflets on Depo Provera (if available)
- Kidney dish for used swabs
- Calendar
- Skin antiseptic or clean water
- Safety box
- Waste bin
- Client appointment card
- MTUHA book No. 8

## Providing Information About Depo Provera

### What is Depo Provera?

- The injectable contraceptives depot medroxyprogesterone acetate (DMPA) contains a progestin like the natural hormone progesterone in a woman's body.
- Does not contain oestrogen, and so can be used throughout breastfeeding and by women who cannot use methods with oestrogen.
- Depo Provera, the most widely used progestin-only injectable, is also known as "the shot," "the jab", the injection, Depo and DMPA.
- Given by injection into the muscle (intramuscular injection). The hormone is then released slowly into the bloodstream.

### Mechanism of Action of Depo Provera

- Works primarily by preventing the release of eggs from the ovaries
- Secondary mechanism: Depo Provera thickens cervical mucus and prevents sperm from entering the uterus

### Effectiveness of Depo Provera

- Effectiveness depends on getting injections regularly: risk of pregnancy increases when a woman misses an injection.
- As commonly used, Depo Provera is 97% effective: about 3 pregnancies will occur per 100 women using progestin-only injectable over the first year.
- When used perfectly (meaning women always have injections on time), Depo Provera is more than 99% effective: less than 1 pregnancy will occur per 100 women using progestin-only injectable over the first year (3 per 1,000 women).

## Characteristics of Depo Provera

### Advantages:

- Highly effective and safe
- Easy to use
- Easy to keep private
- Doesn't interfere with intercourse
- Can be used by women with contraindications for oestrogen
- Has no adverse effect on breastfeeding
- Known health benefits include protection from:
  - Endometrial cancer
  - Uterine fibroids
  - Symptomatic pelvic inflammatory disease
  - Iron-deficiency anaemia
- Reduces symptoms of endometriosis and sickle cell crises
- Has no known health risks

### Disadvantages:

- Commonly causes changes in menstrual bleeding patterns, including:
  - Irregular and/or prolonged bleeding (first 3-6 months)
  - Infrequent bleeding or complete absence of bleeding (at one year). Note that many women consider absence of bleeding an advantage.
- Other side effects include:
  - Weight gain
  - Headaches, dizziness
  - Mood changes
  - Less sex drive
- Delay in return to fertility: it takes on average 9 months for woman to get pregnant after Depo Provera is discontinued
- Loss of bone density while using Depo Provera. However, Depo Provera users have not been found to have more broken bones. When Depo Provera is discontinued, bone density increases again for women of reproductive age. Some caution is warranted in young adolescents as it is not clear whether the loss of bone density prevents them from reaching their potential peak bone mass
- Provides no protection from STIs, including HIV

## Correcting Misunderstandings About Depo Provera

Progestin-only injectables:

- Can stop monthly bleeding, but this is not harmful. It is similar to not having monthly bleeding during pregnancy. Blood is not building up inside the woman.
- Do not disrupt an existing pregnancy.
- Do not make women infertile.

## Who Can Use Depo Provera

Nearly all women can use progestin-only injectables safely and effectively, including women who:

- Have or have not had children
- Are not married
- Are of any age, including adolescents and women over 40 years old
- Have just had an abortion or miscarriage
- Smoke cigarettes, regardless of woman's age or number of cigarettes smoked
- Are breastfeeding (starting as soon as 6 weeks after childbirth)
- Are infected with HIV, whether or not on antiretroviral therapy

Women can begin using progestin-only injectables:

- Without a pelvic examination
- Without any blood tests or other routine laboratory tests
- Without cervical cancer screening
- Without a breast examination

## Screening For Medical Eligibility for Depo Provera

Ask the client the questions below about known medical conditions.

Examinations and tests are not necessary. If she answers "NO" to all of the questions, then she can start Depo Provera if she wants. If she answers "YES" to a question, follow the instructions. In some cases she can still start progestin-only injectable.

**1. Are you breastfeeding a baby less than 6 weeks old?**

No     Yes

If YES, delay initiation of Depo Provera until a baby is 6 weeks old

**2. Do you have severe cirrhosis of the liver, or liver tumour? (Notice if her eyes or skin unusually yellow, which are signs of jaundice)**

No     Yes

If she reports serious active liver disease (jaundice, severe cirrhosis, liver tumour), do not provide Depo Provera. Help her choose a method without hormones.

**3. Do you have high blood pressure?**

No  Yes

If you cannot check blood pressure and she reports having high blood pressure in the past, provide Depo Provera.

Check her blood pressure if possible:

- If she is currently being treated for high blood pressure and it is adequately controlled, or her blood pressure is below 160/100 mm Hg, provide Depo Provera.
- If systolic blood pressure is 160 mm Hg or higher or diastolic blood pressure 100 or higher, do not provide Depo Provera. Help her choose another method (but not the one with oestrogen).

**4. Have you had diabetes for more than 20 years or damage to your arteries, vision, kidneys, or nervous system caused by diabetes?**

No  Yes

If YES, do not provide Depo Provera. Help her choose another method—one without oestrogen.

**5. Have you ever had a stroke, blood clot in your legs or lungs, heart attack, or other serious heart problems?**

No  Yes

If she reports heart attack, heart disease due to blocked or narrowed arteries, or stroke, do not provide Depo Provera. Help her choose another method—one without oestrogen. If she reports a current blood clot in the deep veins of the leg or in the lung (not superficial clots), help her choose a method without hormones.

**6. Do you have vaginal bleeding that is unusual for you?**

No  Yes

If she has unexplained vaginal bleeding that suggests pregnancy or an underlying medical condition, Depo Provera could make diagnosis and monitoring of any treatment more difficult. Help her choose a method to use while being evaluated and treated (but not implants or a copper-bearing or hormonal IUD).

After treatment, re-evaluate for use of Depo Provera.

**7. Do you have or have you ever had breast cancer?**

No  Yes

If YES, do not provide progestin-only injectable. Help her choose a method without hormones.

**8. Do you have several conditions that could increase your chances of heart disease (coronary artery disease) or stroke, such as high blood pressure and diabetes?**

No  Yes

If YES, do not provide Depo Provera. Help her choose another method—one without oestrogen.

**Note:** Be sure to explain the health benefits and risks and the side effects of the method that the client will use. Also, point out any conditions that would make the method inadvisable, when relevant to the client.

## Progestin-Only Injectables for Women with HIV

- Women who are infected with HIV, have AIDS, or are on antiretroviral (ARV) therapy can safely use progestin-only injectables.
- Urge these women to use condoms along with progestin-only injectables. Used consistently and correctly, condoms help prevent transmission of HIV and other STIs.

## Providing Depo Provera

### When to Start

**IMPORTANT:** A woman can start injectable any time she wants if it is reasonably certain she is not pregnant. To be reasonably certain she is not pregnant, use the Pregnancy Checklist (see Chapter 2).

Woman's situation	When to start
<b>Having menstrual cycles or switching from a nonhormonal method</b>	<p><b>Any time of the month</b></p> <ul style="list-style-type: none"> <li>• If she is starting within 7 days after the start of her monthly bleeding, no need for a backup method.</li> <li>• If it is more than 7 days after the start of her monthly bleeding, she can start injectable any time it is reasonably certain she is not pregnant. She will need a backup method* for the first 7 days after the injection.</li> <li>• If she is switching from an IUD, she can start injectable immediately</li> </ul>
<b>Switching from a hormonal method</b>	<ul style="list-style-type: none"> <li>• Immediately, if she has been using the hormonal method consistently and correctly or if it is otherwise reasonably certain she is not pregnant. No need to wait for her next monthly bleeding. No need for a backup method.</li> <li>• If she is switching from another injectable, she can have the new injectable when the repeat injection would have been given. No need for a backup method.</li> </ul>
<b>Fully or nearly fully breastfeeding, less than 6 months after giving birth</b>	<ul style="list-style-type: none"> <li>• If she gave birth less than 6 weeks ago, delay her first injection until at least 6 weeks after giving birth.</li> <li>• If her monthly bleeding has not returned, she can start injectable any time between 6 weeks and 6 months. No need for a backup method.</li> <li>• If her monthly bleeding has returned, she can start injectable as advised for women having menstrual cycles.</li> </ul>
<b>Fully or nearly fully breastfeeding, more than 6 months after giving birth</b>	<ul style="list-style-type: none"> <li>• If her monthly bleeding has not returned, she can start injectable any time it is reasonably certain she is not pregnant. She will need a backup method for the first 7 days after the injection.</li> <li>• If her monthly bleeding has returned, she can start injectable as advised for women having menstrual cycles (see previous page).</li> </ul>
<b>Partially breastfeeding, less than 6 weeks after giving birth</b>	<ul style="list-style-type: none"> <li>• Delay her first injection until at least 6 weeks after giving birth</li> </ul>

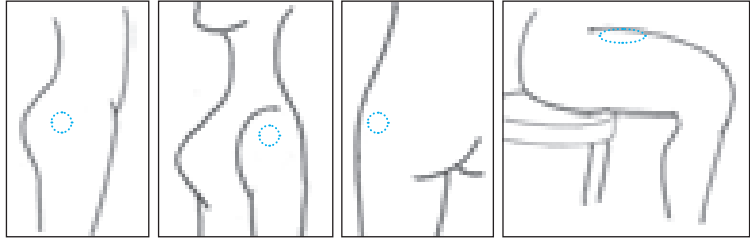
<b>Partially breastfeeding, more than 6 weeks after giving birth</b>	<ul style="list-style-type: none"> <li>• If her monthly bleeding has not returned, she can start injectable any time it is reasonably certain she is not pregnant. She will need a backup method for the first 7 days after the injection.</li> <li>• If her monthly bleeding has returned, she can start injectable as advised for women having menstrual cycles.</li> </ul>
<b>Not breastfeeding, less than 4 weeks after giving birth</b>	<ul style="list-style-type: none"> <li>• She can start injectable at any time. No need for a backup method.</li> </ul>
<b>Not breastfeeding, more than 4 weeks after giving birth</b>	<ul style="list-style-type: none"> <li>• If her monthly bleeding has not returned, she can start injectable any time it is reasonably certain she is not pregnant. She will need a backup method for the first 7 days after the injection.</li> <li>• If her monthly bleeding has returned, she can start injectable as advised for women having menstrual cycles.</li> </ul>
<b>No monthly bleeding (not related to childbirth or breastfeeding)</b>	<ul style="list-style-type: none"> <li>• She can start injectable any time it is reasonably certain she is not pregnant. She will need a backup method for the first 7 days after the injection.</li> </ul>
<b>After miscarriage or abortion</b>	<ul style="list-style-type: none"> <li>• Immediately. If she is starting within 7 days after first- or second-trimester miscarriage or abortion, no need for a backup method.</li> <li>• If it is more than 7 days after first- or second trimester miscarriage or abortion, she can start injectable any time it is reasonably certain she is not pregnant. She will need a backup method for the first 7 days after the injection.</li> </ul>
<b>After taking emergency contraceptive pills (ECPs)</b>	<ul style="list-style-type: none"> <li>• She can start injectable on the same day as the ECPs, or if preferred, within 7 days after the start of her monthly bleeding. She will need a backup method for the first 7 days after the injection. She should return if she has signs or symptoms of pregnancy other than not having monthly bleeding.</li> </ul>

## Counselling About Side Effects

**IMPORTANT:** Thorough counselling about bleeding changes and other side effects must come before giving the injection. Counselling about bleeding changes may be the most important help a woman needs to keep using the method.

- |  |   |
|--|---|
| <b>Describe the most common side effects</b> | <ul style="list-style-type: none"> <li>• For the first several months, irregular bleeding, prolonged bleeding, frequent bleeding. Later, no monthly bleeding.</li> <li>• Weight gain (about 1–2 kg per year), headaches, dizziness, and possibly other side effects.</li> </ul> |
| <b>Explain about these side effects</b>      | <ul style="list-style-type: none"> <li>• Side effects are not signs of illness.</li> <li>• Common, but some women do not have them.</li> <li>• The client can come back for help if side effects bother her.</li> </ul>   |

## Giving the Injection of Depo Provera

<b>Obtain one dose of injectable, needle, and syringe</b>	<ul style="list-style-type: none"> <li>• DMPA: 150 mg for injections into the muscle (intramuscular injection).</li> <li>• Check expiration date. If using an open multidose vial, check that the vial is not leaking.</li> </ul>
<b>Wash</b>	<ul style="list-style-type: none"> <li>• Wash hands with soap and water, if possible.</li> <li>• If injection site is dirty, wash it with soap and water.</li> <li>• No need to wipe site with antiseptic.</li> </ul>
<b>Prepare vial</b>	<ul style="list-style-type: none"> <li>• Gently shake the vial of Depo Provera.</li> <li>• No need to wipe top of vial with antiseptic.</li> <li>• If vial is cold, warm to skin temperature before giving the injection.</li> </ul>
<b>Fill syringe</b>	<ul style="list-style-type: none"> <li>• Pierce top of vial with sterile needle and fill syringe with proper dose.</li> </ul>
<b>Inject formula</b>	<ul style="list-style-type: none"> <li>• Insert sterile needle deep into the hip(ventrogluteal muscle), the upper arm (deltoid muscle), or the buttocks (gluteal muscle, upper outer portion), whichever the woman prefers. Inject the contents of the syringe.</li> <li>• Do not massage injection site.</li> </ul> 
<b>Dispose of disposable syringes and needles safely</b>	<ul style="list-style-type: none"> <li>• Do not recap, bend, or break needles before disposal.</li> <li>• Place in a puncture-proof sharps container.</li> <li>• Do not reuse disposable syringes and needles. They are meant to be destroyed after a single use. Because of their shape, they are very difficult to disinfect. Therefore, reuse might transmit diseases such as HIV and hepatitis.</li> </ul>



## Supporting the user

### ◆ Give specific instructions:

- Tell the client not to massage the injection site
- Tell the client the name of the injection
- Agree on a date for her next injection

### ◆ Plan the next visit

- Agree on a date for her next Depo Provera injection in 3 months (13 weeks). Discuss how to remember the date, perhaps tying it to a holiday or local event.
- Ask her to try to come on time. She may come up to 2 weeks early or 4 weeks late and still get an injection.
- She should come back no matter how late she is for her next injection. If more than 4 weeks late, she should abstain from sex or use condoms until she can get an injection. She can also consider emergency contraceptive pills if she is more than 4 weeks late and she has had unprotected sex in the past 5 days (see Emergency Contraceptive Pills).

### ◆ Explain reasons to return before the next injection

- Assure every client that she is welcome to come back any time if she has problems, questions, or wants another method; or
- She has a major change in health status; or
- She thinks she might be pregnant.

General health advice: Anyone who suddenly feels that something is seriously wrong with her health should immediately seek medical care from a nurse or doctor. Her contraceptive method is most likely not the cause of the condition, but she should tell the nurse or doctor what method she is using.

## Helping Continuing Users

### Repeat Injection Visits

- Ask how the client is doing with the method and whether she is satisfied. Ask if she has any questions or anything to discuss.
- Ask especially if she is concerned about bleeding changes. Give her any information or help that she needs.
- Give her the injection. Injection can be given up to 2 weeks early or up to 4 weeks late.
- Plan for her next injection. Agree on a date for her next injection (in 3 months or 13 weeks). Remind her that she should try to come on time, but she should come back no matter how late she is.
- Every year or so, check her blood pressure if possible.
- Ask a long-term client if she has had any new health problems. Address problems as appropriate.

- Ask a long-term client about major life changes that may affect her needs—particularly plans for having children and STI/HIV risk.
- Follow up as needed.

## Managing Late Injections

Follow the steps below for clients who are returning for reinjection.

### Step 1. Check the records to see when she received her last injection or ask her if she knows her scheduled reinjection date.

- If she is up to 2 weeks before or up to 4 weeks past her scheduled reinjection date, she is within the approved window. Go to Step 2.
- If she is more than 4 weeks past her reinjection date, she is outside of the approved reinjection window. A client who is more than 4 weeks late can receive her next injection if:
  - She has not had sex since 4 weeks after she should have had her last injection, or
  - She has used a backup method or has taken emergency contraceptive pills (ECPs) after any unprotected sex since 4 weeks after she should have had her last injection, or
  - She is fully or nearly fully breastfeeding and she gave birth less than 6 months ago.

She will need a backup method for the first 7 days after the injection.

If the client is more than 4 weeks late and does not meet these criteria, additional steps can be taken to be reasonably certain she is not pregnant, such as pregnancy test or pelvic exam. Note that many women who have been using progestin-only injectable will have no monthly bleeding for at least a few months, even after discontinuation. Thus, asking her to come back during her next monthly bleeding means her next injection could be unnecessarily delayed, possibly leaving her without contraceptive protection.

### Step 2. Ask the client if she has had any new health problems.

- If no new health problems. go to Step 3.
- If there are new health problems that may require switching methods, manage the client appropriately.

If continuation is ruled out, help her choose another method.

If continuation is appropriate, go to Step 3.

### Step 3. Reassure the client about side effects, particularly bleeding changes.

- Remind the client that heavy or irregular bleeding and eventual amenorrhea are common and will not harm her health. If the client has no concerns, go to Step 4.
- If the client has concerns, manage according to recommendations in the national protocols. If she wants to continue using DMPA, go to Step 4.

### Step 4. Give the client a reinjection.

### Step 5. Counsel the client to use condoms, in addition to DMPA, to prevent STIs and HIV.

**Step 6. Plan for the next injection—13 weeks from now.**

- Encourage her to get the reinjection on time and talk with a provider anytime she has questions or concerns.
- Advise her to always come back no matter how late she is for her reinjection.

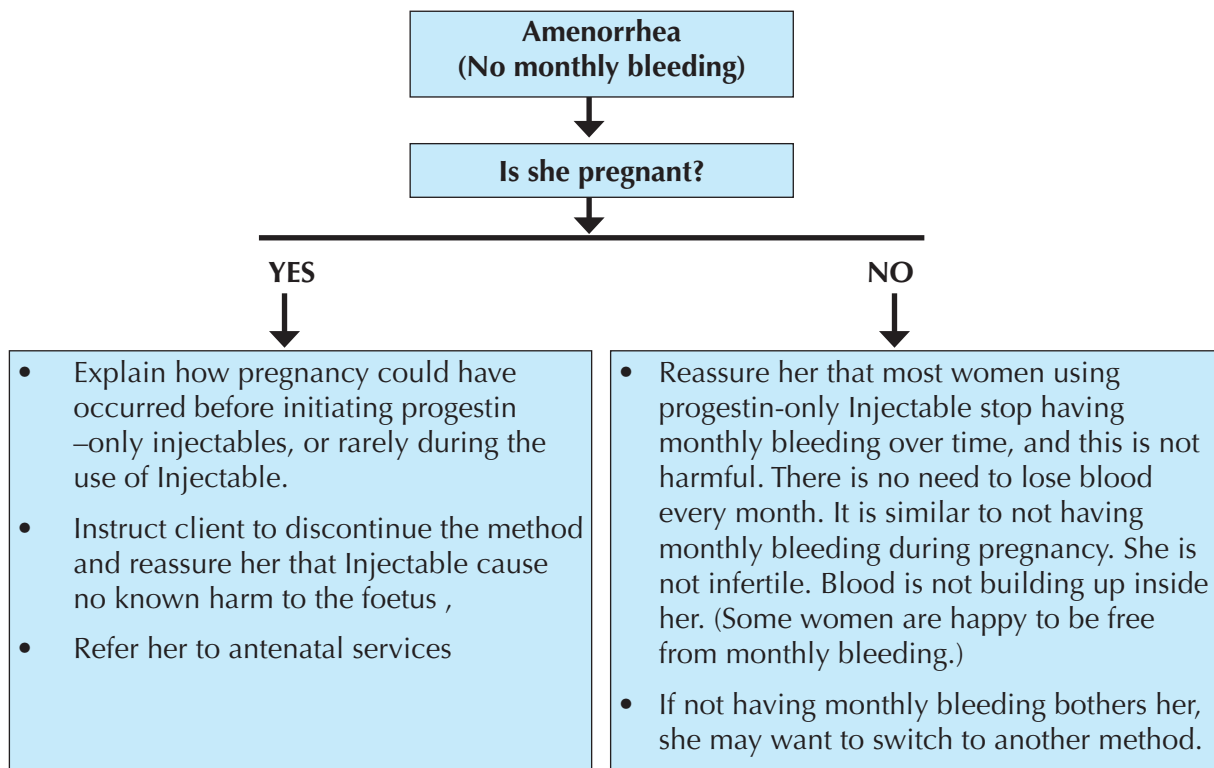
**Step 7. Tell the client that if she is ever more than 4 weeks late for an injection, she should use condoms or abstain from sex until she can come back for a reinjection.**

Also, discuss why the client was late and solutions. If coming back on time is often a problem, discuss using a backup method when she is late for her next injection, taking ECPs, or choosing another method.

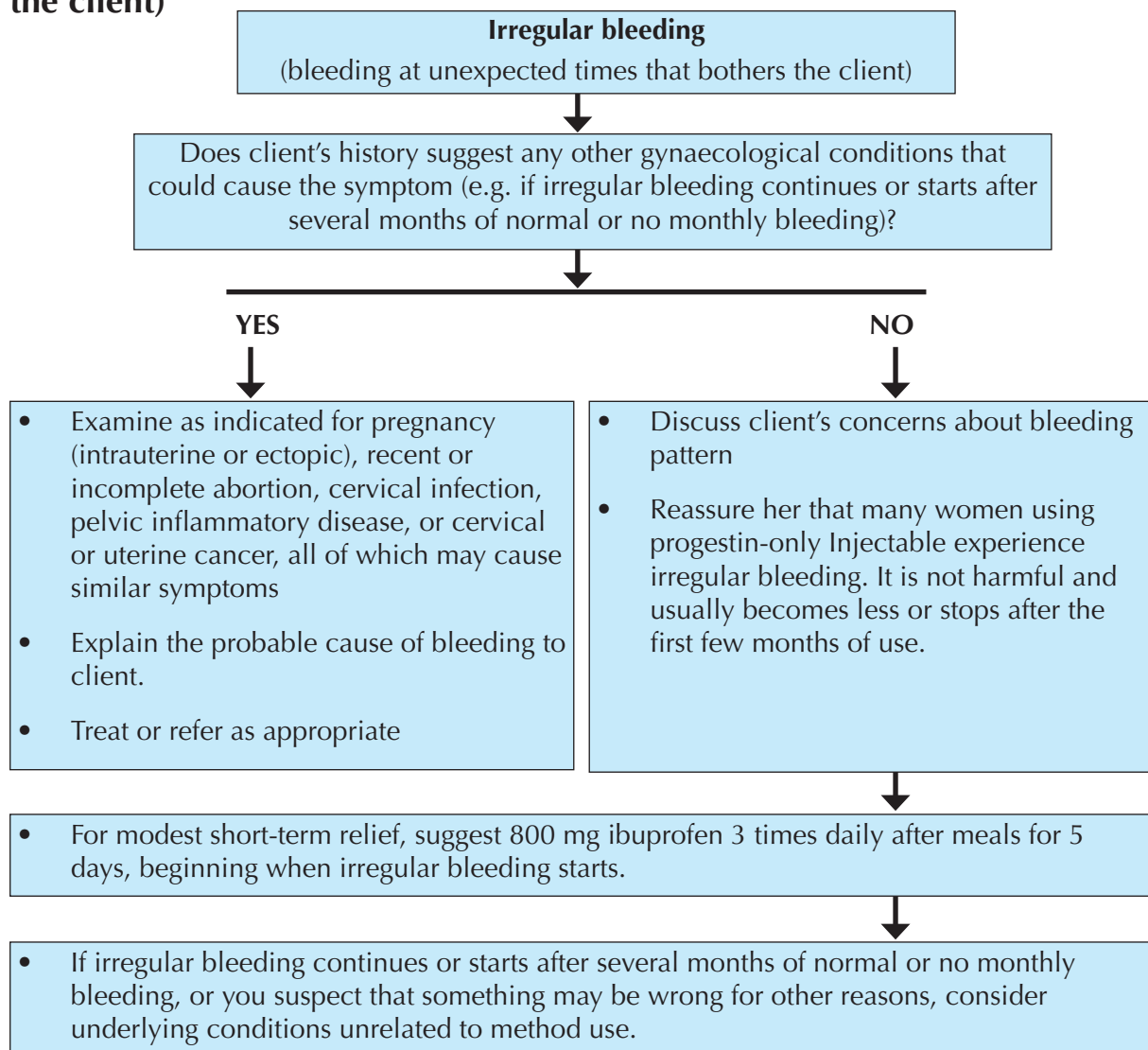
### **Managing Problems Reported as Side Effects**

May or may not be due to the method. Problems with side effects affect women's satisfaction and use of injectable. They deserve the provider's attention. If the client reports side effects, listen to her concerns, give her advice, and, if appropriate, treat. Offer to help the client choose another method—now, if she wishes, or if problems cannot be overcome.

### Managing Amenorrhea (No monthly bleeding)



### Managing irregular bleeding (bleeding at unexpected times that bothers the client)



Management of other problems related to progestin only Injectable

### **Weight gain**

- Review diet and counsel as needed.

### **Abdominal bloating and discomfort**

- Consider locally available remedies.

### **Heavy or prolonged bleeding (twice as much as usual as or longer than 8 days)**

- Reassure her that some women using progestin-only injectable experience heavy or prolonged bleeding. It is not harmful and usually becomes less or stops after a few months.
- For modest short-term relief she can try combined oral contraceptives (COCs), taking one pill daily for 21 days, and beginning when heavy bleeding starts.
- If bleeding becomes a health threat or if the woman wants, help her choose another method. In the meantime, she can take COCs as above to help reduce bleeding.
- To help prevent anaemia, suggest she take iron tablets and tell her it is important to eat foods containing iron, such as meat and poultry (especially beef and chicken liver), fish, green leafy vegetables, and legumes (beans, bean curd, lentils, and peas).
- If heavy or prolonged bleeding continues or starts after several months of normal or no monthly bleeding, or you suspect that something may be wrong for other reasons, consider underlying conditions unrelated to method use.

### **Ordinary headaches (nonmigrainous)**

- Suggest aspirin (325–650 mg), ibuprofen (200–400 mg), paracetamol (325–1000 mg), or other pain reliever.
- Any headaches that get worse or occur more often during use of injectable should be evaluated.

### **Mood changes or changes in sex drive**

- Ask about changes in her life that could affect her mood or sex drive, including changes in her relationship with her partner. Give support as appropriate.
- Clients who have serious mood changes such as major depression should be referred for care.

### **Dizziness**

- Consider locally available remedies.

### **Managing New Problems That May Require Switching Methods**

May or may not be due to the method.

### **Migraine headaches**

- If she develops migraine headaches without aura, she can continue to use the method if she wishes.
- If she has migraine aura, do not give re-injection. Help her choose a method without hormones.

### **Unexplained vaginal bleeding (that suggests a medical condition not related to the method)**

- Refer or evaluate by history and pelvic examination. Diagnose and treat as appropriate.
- If no cause of bleeding can be found, consider stopping progestin-only injectable to make diagnosis easier. Provide another method of her choice to use until the condition is evaluated and treated (not implants or a copper-bearing or hormonal IUD).
- If bleeding is caused by sexually transmitted infection or pelvic inflammatory disease, she can continue using progestin-only injectable during treatment.

### **Certain serious health conditions (suspected blocked or narrowed arteries, liver disease, severe high blood pressure, blood clots in deep veins of legs or lungs, stroke, breast cancer, or damage to arteries, vision, kidneys, or nervous system caused by diabetes)**

- Do not give next injection.
- Give her a backup method to use until the condition is evaluated.
- Refer for diagnosis and care if not already under care.

### **Suspected pregnancy**

- Assess for pregnancy.
- Stop injections if pregnancy is confirmed.
- There are no known risks to a foetus conceived while a woman is using injectable.

# CHAPTER 9:

## CONDOMS

### Overview

This chapter covers information related to the provision of male and female condoms, including:

- Definition
- Effectiveness
- Benefits
- Instructions on how to use correctly and
- Counselling issues

Male and female condoms are the only two methods that provide protection from both pregnancy and STIs, including HIV. They prevent pregnancy by forming a physical barrier that prevents sperm from entering woman's reproductive tract. The barrier also keeps many infectious microorganisms out. Male condom is a sheath, or covering made of thin latex rubber to fit a man's erected penis. Female condom is a sheath, or lining made of thin, soft plastic film that fits loosely inside a woman's vagina. Condom effectiveness depends greatly on client's ability to use it consistently and correctly. Consistent use requires both male and female partner's cooperation. Talking about condom use before sex can improve the chances one will be used.

### Advance preparation

- Male and female condoms
- Penile Model
- Vaginal/pelvic models (where available)
- Tissue or paper for wrapping used condom before disposal
- Waste bin
- MTUHA Book 8
- RCH No 5: Family Planning Card

## I. Male Condoms

### Providing information about male condoms

#### What Are Male Condoms?

- Sheaths, or coverings, that fit over a man's erect penis.

Also called rubbers, "raincoats," "umbrellas," skins, and prophylactics; known by many different brand names.

Most are made of thin latex rubber.

#### Misconceptions and Facts about Condoms

Misconceptions	Facts
Condoms break a lot and are not reliable	Condoms are tested extensively for breakage by independent labs and are retested electronically for safety by Tanzania Bureau of Standards (TBS) before being distributed to the general public for use.  Condom breakage is extremely rare if they are stored correctly and are not used with oil-based lubricants.
Condoms reduce sexual pleasure	While condoms can reduce the sensation somewhat for some men, they may increase sexual pleasure for other men, for example by improving performance in males with premature ejaculation
Most condoms are made too small for most men	All condoms can be stretched to a much bigger size than a man's penis without breaking. This is part of the routine condom testing in labs.
Condoms contain HIV	Condoms do not contain HIV, in contrast they prevent HIV and other STIs if used correctly and consistently. HIV cannot survive in non living things like condoms.
Condoms fall off and get lost in the woman's body	If the penis is withdrawn when still hard and while holding the base of the condom, the condom will not slip off. If for some reason it did, it will remain in woman's vagina and could be removed using one's finger. There is no way for a condom to disappear in the woman's body.
Condoms have holes that allow the HIV to go through	Well kept condoms are tested and do not allow any virus to go through.
Condoms irritate the genitalia	This is extremely rare. The very few clients who feel irritation of genitalia should seek advice from health service providers

#### Mechanism of action of male condoms

Work by forming a barrier that keeps sperm out of the vagina, preventing pregnancy. Also keep infections in semen, on the penis, or in the vagina from infecting the other partner.

#### Effectiveness of male condoms

Effectiveness depends on the user: Risk of pregnancy or sexually transmitted infection (STI) is greatest when condoms are not used with every act of sex.

Very few pregnancies or infections occur due to condom slips, or breaks.



As commonly used, about 15 pregnancies per 100 women whose partners use male condoms over the first year. This means that 85 of every 100 women whose partners use male condoms will not become pregnant.

When used correctly **with every act of sex**, about 2 pregnancies per 100 women whose partners use male condoms over the first year. This means that in perfect use condoms are 98% effective

### **Characteristics of male condoms**

- Immediately effective
- Safe
- Offer contraception only when needed (no daily intake)
- Easy to obtain, can be used without seeing a health care provider
- Can be used as a temporary or backup method
- Have no hormonal side effects
- Return to fertility is immediate – as soon as condom is not used
- Can be used by almost every man
- Easy to use with a little practice
- Can reduce sensation (helps to prevent premature ejaculation)
- No health risk associated with the method except in extremely rare cases where one can get severe allergic reactions (people with latex allergy)
- Highly effective protection against some STIs and HIV (if used consistently and correctly)
- May help protect against conditions caused by STIs:
  - Recurring pelvic inflammatory disease and chronic pelvic pain
  - Cervical cancer
  - Infertility (male and female)

### **Protection against HIV and other STIs:**

Male condoms significantly reduce the risk of becoming infected with HIV when used correctly with every act of sex.

When used consistently and correctly, condom use prevents 80% to 95% of HIV transmission that would have occurred without condoms

- Condoms reduce the risk of becoming infected with many STIs when used consistently and correctly:
  - Protect best against STIs spread by discharge, such as HIV, gonorrhoea, and chlamydia (non-ulcerative STIs).
  - Protect to a lesser degree against STIs spread by skin-to-skin contact, such as syphilis, herpes and human papillomavirus (ulcerative STIs).

## Ensure Medical Eligibility for male condoms

All men and women can safely use male condoms except those with:  
Severe allergic reaction to latex rubber

## Providing Male Condoms

**When to Initiate;** Any time the client wants

## Explaining how to use

**IMPORTANT:** Whenever possible, show clients how to put on a condom.  
Use a model of a penis, if available

Explain the 5 Basic Steps of Using a Male Condom	
Basic Steps	Important Details
<b>Use a new condom for each act of sex</b>	<p>Check the condom package.</p> <ul style="list-style-type: none"> <li>– Do not use if torn or damaged.</li> <li>– Avoid using a condom past the expiration date</li> <li>– Tear open the package carefully.</li> <li>– Do not use fingernails, teeth, or anything that can damage the condom.</li> </ul>
<b>Before any physical contact, place the condom on the tip of the erect penis with the rolled side out</b>	<p>For the most protection, put the condom on before the penis makes any genital, oral, or anal contact.</p>
<b>Unroll the condom all the way to the base of the erect penis</b>	<p>The condom should unroll easily. Forcing it on could cause it to break during use.</p> <p>If the condom does not unroll easily, it may be on backwards, damaged, or too old.</p> <p>Throw it away and use a new condom.</p> <p>If the condom is on backwards and another one is not available, turn it over and unroll it onto the penis.</p>
<b>Immediately after ejaculation, hold the rim of the condom in place and withdraw the penis while it is still erect</b>	<p>Withdraw the penis.</p> <p>Slide the condom off, avoiding spilling semen.</p> <p>If having sex again or switching from one sex act to another, use a new condom</p>
<b>Dispose of the used condom safely</b>	<p>Wrap the condom in its package and put in the latrine or burning into ashes</p> <p>Do not put the condom into a flush toilet, as it can cause problems with plumbing.</p>



1. Remove the condom from the package carefully, to avoid tearing



2. Squeeze the air out of the tip of the condom



3. Unroll the condom onto the erect penis



4. After ejaculation, withdraw the penis from the vagina while the penis is still erect. Hold on to the rim of the condom while withdrawing to prevent it from slipping off and semen spilling into the vagina



5. Remove condom from penis, and tie a knot in it to prevent spills or leaks. Dispose of condom safely (Where it cannot cause any hazard)

## Supporting the user

<b>Ensure client understands correct use</b>	Ask the client to explain the 5 basic steps of using a condom by putting it on a model and then taking it off.
<b>Ask clients how many condoms they will need until they can return</b>	Give plenty of condoms Tell clients where they can buy condoms, if needed.
<b>Explain why using a condom with every act of sex is important</b>	Just one unprotected act of sex can lead to pregnancy or STI and HIV—or both.  If a condom is not used for one act of sex, try to use one the next time. A mistake once or twice does not mean that it is pointless to use condoms in the future.
<b>Explain about emergency Contraceptive pills (ECPs)</b>	Explain ECP use in case of errors in condom use—including not using a condom—to help prevent pregnancy (see Emergency Contraceptive Pills).  Give ECPs, if available.

## Advise the Condom Users what they should not do

Some practices can increase the risk that the condom will break and should be avoided.

- Do not unroll the condom first and then try to put it on the penis
- Do not use lubricants with an oil base because they damage latex
- Do not use a condom if the colour is uneven or changed
- Do not use a condom that feels brittle, dried out, or very sticky
- Do not reuse condoms
- Do not have dry sex

Do not use the same condom for more than one sexual act. Also do not use the same condom when switching between different penetrative sexual acts, such as from anal to vaginal sex. This can transfer bacteria that can cause infection.

## Reasons to return

Assure every client that she or he is welcome to come back any time—for example, if he or she has problems, questions, or wants another method or she thinks she might be pregnant. Also if:

- Client has difficulty using condoms correctly or every time he or she has sex.
- Client has signs or symptoms of severe allergic reaction to latex condom
- Woman recently had unprotected sex and wants to avoid pregnancy. She may be able to use ECPs (see Emergency Contraceptive Pills).

## Helping Continuing Users

Ask clients how they are doing with the method and whether they are satisfied. Ask if they have any questions or anything to discuss.

Ask especially if they are having any trouble using condoms correctly and every time they have sex. Give clients any information or help that they need.

Give clients more condoms and encourage them to come back for more before their supply runs out. Remind them where else they can obtain condoms.

Ask a long-term client about major life changes that may affect her or his needs—particularly plans for having children and STI and HIV risk.

Follow up as needed

## **Managing Any problems**

### **Problems With Use**

May or may not be due to the method.

Problems with condoms affect clients' satisfaction and use of the method. They deserve the provider's attention. If the client reports any problems, listen to the client's concerns and give advice.

Offer to help the client choose another method—now, if he or she wishes, or if problems cannot be overcome—unless condoms are needed for protection from STIs, including HIV.

### **Condom breaks, slips off the penis, or is not used**

ECPs can help prevent pregnancy in such cases (see Emergency Contraceptive Pills). If a man notices a break or slip, he should tell his partner so that she can use ECPs if she wants.

Little can be done to reduce the risk of STIs if a condom breaks, slips, or is not used. If the client has signs or symptoms of STIs after having unprotected sex, assess or refer.

If a client reports breaks or slips:

- Ask clients to show how they are opening the condom package and putting the condom on, using a model. Correct any errors.
- Ask if any lubricants are being used. The wrong lubricant or too little lubricant can increase breakage. Too much lubricant can cause the condom to slip off.
- Ask when the man withdraws his penis. Waiting too long to withdraw, when the erection begins to subside, can increase the chance of slips.

### **Difficulty putting on the condom**

Ask clients to show how they put the condom on, using a model. Correct any errors.

### **Difficult persuading partner to use condoms or not able to use a condom every time**

Discuss ways to talk about condoms with partner and also dual protection rationales

Consider combining condoms with:

- Another effective contraceptive method for better pregnancy protection.
- If no risk of STIs and HIV, a fertility awareness method, and using condoms only during the fertile time

Especially if the client or partner is at risk for STIs and HIV, encourage continued condom use while working out problems. If neither partner has an infection, a mutually faithful sexual relationship provides STI and HIV protection without requiring condom use but does not protect against pregnancy.

**Mild irritation in or around the vagina or penis or mild allergic reaction to condom (itching, redness, rash and/or swelling of genitals, groin, or thighs during or after condom use).**

Suggest trying another brand of condoms. A person may be more sensitive to one brand of condoms than to others.

Suggest putting lubricant or water on the condom to reduce rubbing that may cause irritation.

If symptoms persist, assess or refer for possible vaginal infection or STI as appropriate.

- If there is no infection and irritation continues or recurs, the client may have an allergy to latex.
- If not at risk of STIs, including HIV, help the client choose another method.
- If the client or partner is at risk for STIs, suggest using female condoms or plastic male condoms, if available. If not available, urge continued use of latex condoms. Tell the client to stop using latex condoms if symptoms become severe.
- If neither partner has an infection, a mutually faithful sexual relationship provides STI protection without requiring condom use but does not protect against pregnancy.

## **New Problems That May Require Switching Methods**

May or may not be due to the method.

### **Female partner is using miconazole or econazole ( for treatment of vaginal infections)**

A woman should not rely on latex condoms during vaginal use of miconazole or econazole. They can damage latex. (Oral treatment will not harm condoms.)

She should use female condoms or plastic male condoms, another contraceptive method, or abstain from sex until treatment is completed.

### **Severe allergic reaction to condom (hives or rash over much of body, dizziness, difficulty breathing, or loss of consciousness during or after condom use).**

Tell the client to stop using latex condoms.

Refer for care, if necessary. Severe allergic reaction to latex could lead to life-threatening anaphylactic shock. Help the client choose another method.

If the client or partner cannot avoid risk of STIs and HIV, suggest they use female condoms or plastic male condoms, if available. If neither partner has an infection, a mutually faithful sexual relationship provides STI and HIV protection without requiring condom use but does not protect against pregnancy

## II. Female condoms

### Overview

The female condom is made of thin, transparent, soft plastic (synthetic material). Male and female condoms are the only contraceptive method that can protect against both pregnancy and sexually transmitted infections, including HIV. It requires correct use with every act of sex for greatest effectiveness. A woman can initiate female condom use but the method requires her partner's cooperation.

The female condom requires some practices in inserting it correctly into vagina and removing it. It becomes easier with experience.

### Advance Preparation

Female condoms

Pelvic model

Toilet tissue or piece of paper for wrapping used condom before disposal

MTUHA Book 8

RCH No 5: Family Planning Card

Waste bin

### Providing information about female condoms

#### What is female condom?

Sheaths, or linings, that fit loosely inside a woman's vagina, made of thin, transparent, soft plastic film.

- Have flexible rings at both ends
- One ring at the closed end helps to insert the condom
- The ring at the open end holds part of the condom outside the vagina

Lubricated with a silicone-based lubricant on the inside and outside.

#### Mechanism of action of female condoms

Work by forming a barrier that keeps sperm out of the vagina, preventing pregnancy. Also keep infections in semen, on the penis, or in the vagina from infecting the other partner.

#### Effectiveness

Effectiveness depends on the user: Risk of pregnancy or sexually transmitted infection (STI) is greatest when female condoms are not used with every act of sex. Few pregnancies or infections occur due to incorrect use, slips, or breaks.

#### Protection against pregnancy:

As commonly used, about 21 pregnancies occur per 100 women using female condoms over the first year. This means that 79 of every 100 women using female condoms will not become pregnant.

When used perfectly with every act of sex, about 5 pregnancies occur per 100 women using female condoms over the first year (95% effective).

#### **Protection against HIV and other STIs:**

Female condoms reduce the risk of infection with STIs, including HIV, when used correctly with every act of sex.

### **Characteristics of female condom**

Safe and effective if used properly

Woman controlled method

No health risks or side effects

No need to see health care provider before using

Easy to use with a little practice.

Fertility returns as soon as condom is not used

Texture feels more natural than male condom

Can be inserted ahead of time, so do not interrupt sex

Do not have to be removed immediately after ejaculation

Do not dull the sensation like male condom

Protects against STIs; HIV and AIDS with consistent and proper use

### **Ensure Medical Eligibility for female condoms**

All women can use female condoms. No medical conditions prevent the use of this method.

### **Providing Female Condoms**

#### **When to Initiate**

Any time the client wants.

### **Explaining How to Use**

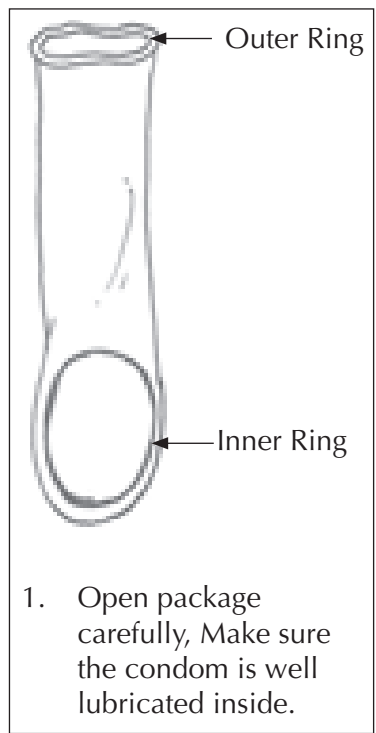
**IMPORTANT:** Whenever possible, show the client how to insert the female condom. Use a model to demonstrate. You can create an opening similar to a vagina with one hand and show how to insert the female condom with the other hand.

### **Explain the 5 Basic Steps of Using a Female Condom**

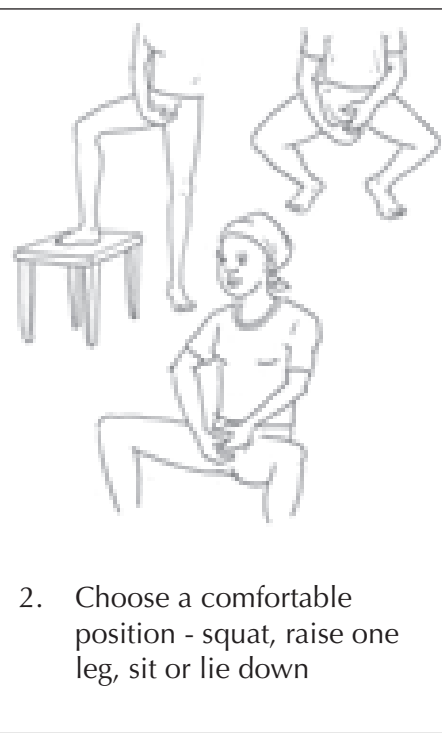
<b>Basic Steps</b>	<b>Important Details</b>
<b>Use a new female condom for each act of sex</b>	Check the condom package. Do not use if torn or damaged. Avoid using a condom past the expiration date.  If possible, wash your hands with mild soap and clean water before inserting the condom.



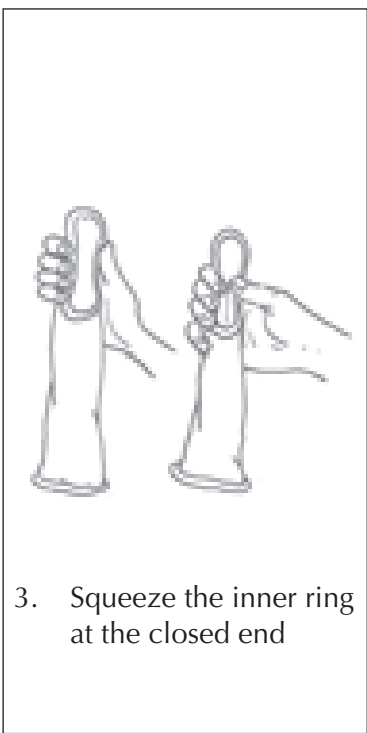
Basic Steps	Important Details
<p><b>Before any physical contact, insert the condom into the vagina</b></p>	<p>Can be inserted up to 8 hours before sex. For the most protection, insert the condom before the penis comes in contact with the vagina.</p> <p>Choose a position that is comfortable for insertion—squat, raises one leg, sit, or lie down.</p> <p>Rub the sides of the female condom together to spread the lubricant evenly.</p> <p>Grasp the ring at the closed end, and squeeze it so it becomes long and narrow.</p> <p>With the other hand, separate the outer lips (labia) and locate the opening of the vagina.</p> <p>Gently push the inner ring into the vagina as far up as it will go. Insert a finger into the condom to push it into place. About 2 to 3 centimetres of the condom and the outer ring remain outside the vagina.</p>
<p><b>Ensure that the penis enters the condom and stays inside the condom</b></p>	<p>The man or woman should carefully guide the tip of his penis inside the condom—not between the condom and the wall of the vagina. If his penis goes outside the condom, withdraw and try again.</p> <p>If the condom is accidentally pulled out of the vagina or pushed into it during sex, put the condom back in place.</p>
<p><b>After the man withdraws his penis, hold the outer ring of the condom, twist to seal in fluids, and gently pull it out of the Vagina</b></p>	<p>The female condom does not need to be removed immediately after sex.</p> <p>Remove the condom before standing up, to avoid spilling semen.</p> <p>If the couple has sex again, they should use a new condom.</p> <p>Reuse of female condoms is not recommended</p>
<p><b>Dispose of the used condom safely</b></p>	<p>Wrap the condom in its package and put it in the rubbish or latrine.</p> <p>Do not put the condom into a flush toilet, as it can cause problems with plumbing.</p>



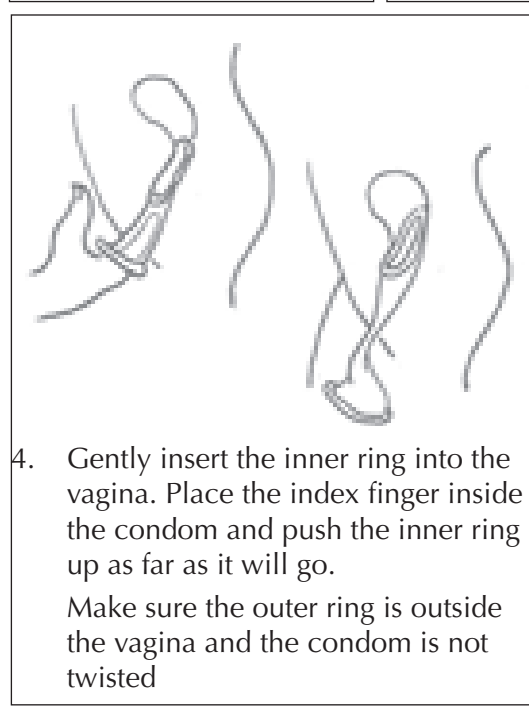
1. Open package carefully, Make sure the condom is well lubricated inside.



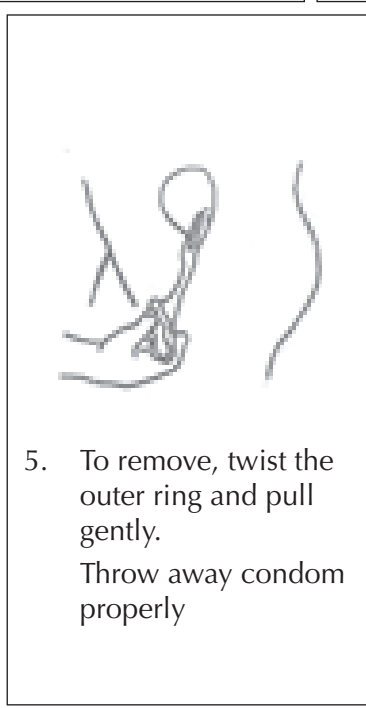
2. Choose a comfortable position - squat, raise one leg, sit or lie down



3. Squeeze the inner ring at the closed end



4. Gently insert the inner ring into the vagina. Place the index finger inside the condom and push the inner ring up as far as it will go. Make sure the outer ring is outside the vagina and the condom is not twisted



5. To remove, twist the outer ring and pull gently. Throw away condom properly

**BE SURE THAT THE PENIS ENTERS THE CONDOM AND STAYS INSIDE IT DURING INTERCOURSE.**

## Supporting the user

<b>Ensure client understands correct use of female condom</b>	Ask the client to explain the 5 basic steps of using the female condom while handling one.  If a model is available, the client can practice inserting the condom in the model and then taking it out.
<b>Ask the client how many condoms she thinks she will need until she can return</b>	Give plenty of condoms  Tell the client where she can buy female condoms, if needed.
<b>Explain why using a condom with every act of sex is important</b>	Just one unprotected act of sex can lead to pregnancy or STI or HIV—or both.  If a condom is not used for one act of sex, try to use one the next time. A mistake once or twice does not mean that it is pointless to use condoms in the future.
<b>Explain about emergency contraceptive pills (ECPs)</b>	Explain ECP use in case of errors in condom use—including not using a condom—to help prevent pregnancy (see Emergency Contraceptive Pills). Give ECPs if available.
<b>Discuss ways to talk about using condoms</b>	Discuss skills and techniques for negotiating condom use with partners  <ul style="list-style-type: none"> <li>– Ensure partner understands the purpose of the discussion.</li> <li>– Choose the best moment to discuss condom use, usually before sexual activities.</li> <li>– Be prepared to listen to partner’s concerns, keep an open mind.</li> <li>– Promote and cite positive examples and advantage of using condoms.</li> <li>– Be assertive rather than aggressive, persuade rather than threaten the partner.</li> <li>– Be confident and firm; establish personal limits in advance, e.g. what you can and cannot do and that your health is foremost and cannot be compromised.</li> <li>– Prepare responses to all arguments that the partner may use, to increase self-confidence.</li> </ul>

## Tips for New Users

Suggest to a new user that she practice putting in and taking out the condom before the next time she has sex. Reassure her that correct use becomes easier with practice. A woman may need to use the female condom several times before she is comfortable with it.

Suggest she try different positions to see which way insertion is easiest for her.

The female condom is slippery. Some women find insertion easier if they put it in slowly, especially the first few times.

If a client is switching from another method to the female condom, suggest that she continue with the previous method until she can use the female condom with confidence.

## Reasons to return

Assure every client that she is welcome to come back any time—for example, if she has problems, questions, or wants another method; she has any major change in health status; or she thinks she might be pregnant.

### Also if:

She has difficulty using female condoms correctly or every time she has sex.

She recently had unprotected sex and wants to avoid pregnancy. She may be able to use ECPs (see Emergency Contraceptive Pills).

## Helping Continuing Users

Ask how the client is doing with the method and whether she is satisfied. Ask if she has any questions or anything to discuss.

Ask especially if she has any trouble using female condoms correctly and every time she has sex. Give her any information or help that she needs

Give her more female condoms and encourage her to come back for more before her supply runs out. Remind her where else she can obtain female condoms.

Ask a long-term client about major life changes that may affect her needs—particularly plans for having children, STI and HIV risk.

Follow up as needed.

## Managing any problems

### Problems with Use

May or may not be due to the method.

Problems with condoms affect clients' satisfaction and use of the method. They deserve the provider's attention. If the client reports any problems, listen to her concerns and give advice.

Offer to help the client choose another method—now, if she wishes, or if problems cannot be overcome—unless condoms are needed for protection from STIs, including HIV.

### Difficulty inserting the female condom

Ask the client how she inserts a female condom. If a model is available, ask her to demonstrate and let her practice with the model. If not, ask her to demonstrate using her hands. Correct any errors.

### Inner ring uncomfortable or painful

Suggest that she reinsert or reposition the condom so that the inner ring is tucked back behind the pubic bone and out of the way.

### Condom squeaks or makes noise during sex

Suggest adding more lubricant to the inside of the condom or onto the penis. Any lubricant can be used with female condom because plastic is not affected by oil-based ones.

**Condom slips, is not used, or is used incorrectly used, or is used incorrectly**

ECPs can help prevent pregnancy (see Emergency Contraceptive Pills).

Little can be done to reduce the risk of STIs if a condom breaks, slips, or is not used). If the client has signs or symptoms of STIs after having unprotected sex, assess or refer.

If a client reports slips, she may be inserting the female condom incorrectly. Ask her to show how she is inserting the condom, using a model. Correct any errors.

**Difficulty persuading partner to use condoms or not able to use a condom every time**

Discuss ways to talk with her partner about the importance of condom use for protection from pregnancy and STIs.

**Mild irritation in or around the vagina or penis (itching, redness, or rash)**

Usually goes away on its own without treatment.

Suggest adding lubricant to the inside of the condom or onto the penis to reduce rubbing that may cause irritation.

If symptoms persist, assess and treat for possible vaginal infection or STI, as appropriate.

- If there is no infection, help the client choose another method unless the client is at risk for STIs, including HIV
- For clients at risk of STIs, including HIV, suggest using male condoms. If using male condoms is not possible, urge continued use of female condoms despite discomfort. If neither partner has an infection, a mutually faithful sexual relationship provides STI protection without requiring condom use but does not protect against pregnancy.

**Suspected pregnancy**

Assess for pregnancy.

A woman can safely use female condoms during pregnancy for continue STI protection



## **CHAPTER 10:**

# **Natural Family Planning METHODS**

### **Overview**

This chapter will cover Natural Family Planning Methods, such as Fertility Awareness Methods, Withdrawal and Lactational Amenorrhea Method

## I. Fertility Awareness Based Methods

Fertility awareness methods is a collection of practices that help a woman know which days of the month she is likely to get pregnant. It comprises calendar-based methods (Rhythm Method, Standard Days Method) and symptoms-based methods (Two Day Method, Basal Temperature Method (BBT), Billings Ovulation Method or Cervical Mucus, and Symptothermal Method)

Fertility awareness methods require motivation and ability to use them correctly; they also require partner's commitment and cooperation to use a barrier method or abstain on fertile days. The woman is required to stay aware of body changes or keep track of days according to rule of the specific method. Effectiveness of these methods varies dramatically depending on client's ability to use them correctly. These methods can be used by all women of reproductive age who have regular menstrual cycles and are able to maintain effective events records.

### Definition of Terms

- **Fertile time** days during woman's menstrual cycle when she can become pregnant
- **Perfect use** If method always used consistently and correctly
- **Typical use** If method is occasionally used incorrectly or not used
- **Caution** means that additional or special counselling may be needed ensure correct use of the method.
- **Delay** means that use of a particular fertility awareness method should be delayed until the condition is evaluated or corrected. Give the client another method to use until she can start the calendar- based method.

### Advance Preparation

- CycleBeads
- TwoDay Method card
- Chart for observing cervical mucus

Chart to demonstrate three variations of the menstrual cycle-short, average and long cycles such as:

- Menstruation/ Bleeding/Spotting.....Red -- --'R'
- Dry sensation of vulva.....Green ---'G'
- Stretchy fertile mucus.....White ---'W'
- Thick and Sticky Mucus.....Yellow---'Y'

- Relevant IEC Materials
- Calendar
- RCH No. 5: Family Planning Card
- MTUHA Book 8

### Providing Information About Fertility Awareness Methods

#### What are fertility awareness methods?

- Fertility awareness methods rely on woman's ability to identify when the fertile time of her menstrual cycle starts and ends
- Sometimes called periodic abstinence or natural family planning



- A woman can use several ways, alone or in combination, to tell when fertile time begins and ends.
  - **Calendar-based methods** involve keeping track of days of the menstrual cycle to identify the start and end of the fertile time.
    - ◆ Examples: Standard Days Method and calendar rhythm method.
  - **Symptoms-based methods** depend on observing signs of fertility.
    - ◆ Ovulation method (also known as Billings method or cervical mucus method TwoDay Method: a woman is fertile on days she notices the presence of secretions or if she noticed them the day before.
    - ◆ Basal body temperature (BBT): A woman’s resting body temperature goes up slightly after the release of an egg (ovulation), when she could become pregnant. Her temperature stays higher until the beginning of her next monthly bleeding
    - ◆ Symptothermal method.

### **Mechanism of action of the fertility awareness methods**

Work primarily by helping a woman know when she could become pregnant. The couple prevents pregnancy by avoiding unprotected vaginal sex during these fertile days—usually by abstaining or by using condoms. Some couples use withdrawal, but it is among the least effective methods.

### **Effectiveness**

Effectiveness varies by method and depends on the user: Risk of pregnancy is greatest when couples have sex on the fertile days without using another method.

For BBT, Ovulation, Symptothermal and Rhythm methods, as commonly used, in the first year about 25 pregnancies per 100 women using periodic abstinence. This means that 75 of every 100 women who used them in one year will not become pregnant (although how these women identified their fertile time is not known).

For newer fertility awareness methods like the TwoDay Method and Standard Days Method, which are easier to use and, thus, more effective, as commonly used their effectiveness is about 85% , which means 15 of every 1pp

In general, abstaining during fertile times is more effective than using another method during fertile times. The table below provides efficacy rates established through clinical trials of these Fertility Awareness Methods

## Pregnancy Rates with Consistent and Correct Use and Abstinence on Fertile Days

(Pregnancy rates with typical use vary greatly)

Method	Pregnancies per 100 Women Over the First Year	
	Correct Use	Typical Use
<b>Calendar-based methods</b>		
Standard Days Method	5	12
Calendar Rhythm Method		
<b>Symptoms-Based Methods</b>		
Two Day Method	4	14
Basal Body Temperature (BBT) Method	1	
Ovulation Method	3 - 5	20-22
Symptothermal Method	2 - 5	18 - 22

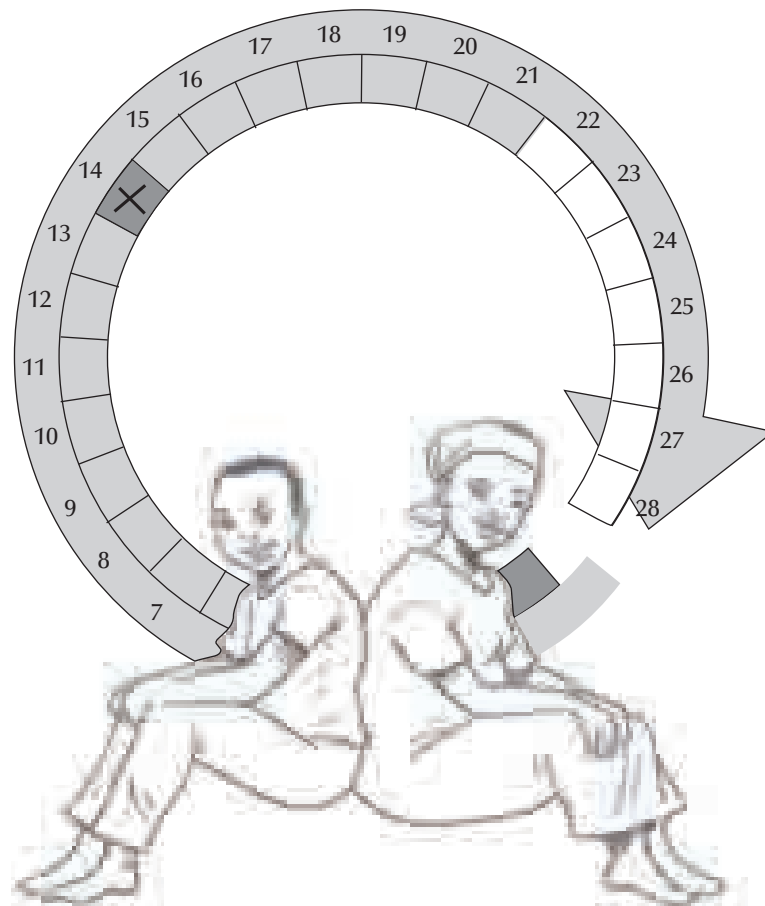
### Characteristics of fertility awareness based methods

- Help protect against risks of pregnancy
- No side effects
- Improved knowledge of reproductive system and possible closer relationship between couples
- Do not require procedures and usually few supplies
- Allow some couples to adhere to their religious and cultural norms about contraception
- Can be used to identify fertile days by both women who want to become pregnant and women who want to avoid pregnancy
- Require skills and partner's cooperation
- Require motivation
- Offer no protection from STIs, including HIV

### Relationship/Interaction with HIV

Women who are infected with HIV, have AIDS, or are on antiretroviral (ARV) therapy can safely use fertility awareness methods if they have regular menstrual cycles.

Urge these women to use condoms along with fertility awareness methods. Used consistently and correctly, condoms help prevent transmission of HIV and other STIs. Condoms also provide extra contraceptive protection for women on ARV therapy.



## Calendar-based Methods

### Medical Eligibility for Calendar-Based Methods

All women can use calendar-based methods. No medical conditions prevent the use of these methods, but some conditions can make them harder to use effectively.

In the following situations use *caution* with calendar-based methods:

Menstrual cycles have just started or have become less frequent or stopped due to older age (Menstrual cycle irregularities are common in young women in the first several years after their first monthly bleeding and in older women who are approaching menopause. Identifying the fertile time may be difficult.)

In the following situations *delay* starting calendar-based methods:

Recently gave birth or is breastfeeding (*Delay* until she has had at least 3 menstrual cycles and her cycles are regular again. For several months after regular cycles have returned, use with *caution*.)

Recently had an abortion or miscarriage (*Delay* until the start of her next monthly bleeding.)

Irregular vaginal bleeding

In the following situations *delay* or use *caution* with calendar-based methods:

Taking any mood-altering drugs such as anti-anxiety therapies, antidepressants, re-uptake inhibitors, long-term use of certain antibiotics, or long-term use of any non steroidal anti-inflammatory drug (such as aspirin, ibuprofen, or Paracetamol). These drugs may delay ovulation.

## Providing Calendar – Based Methods

### When to Initiate

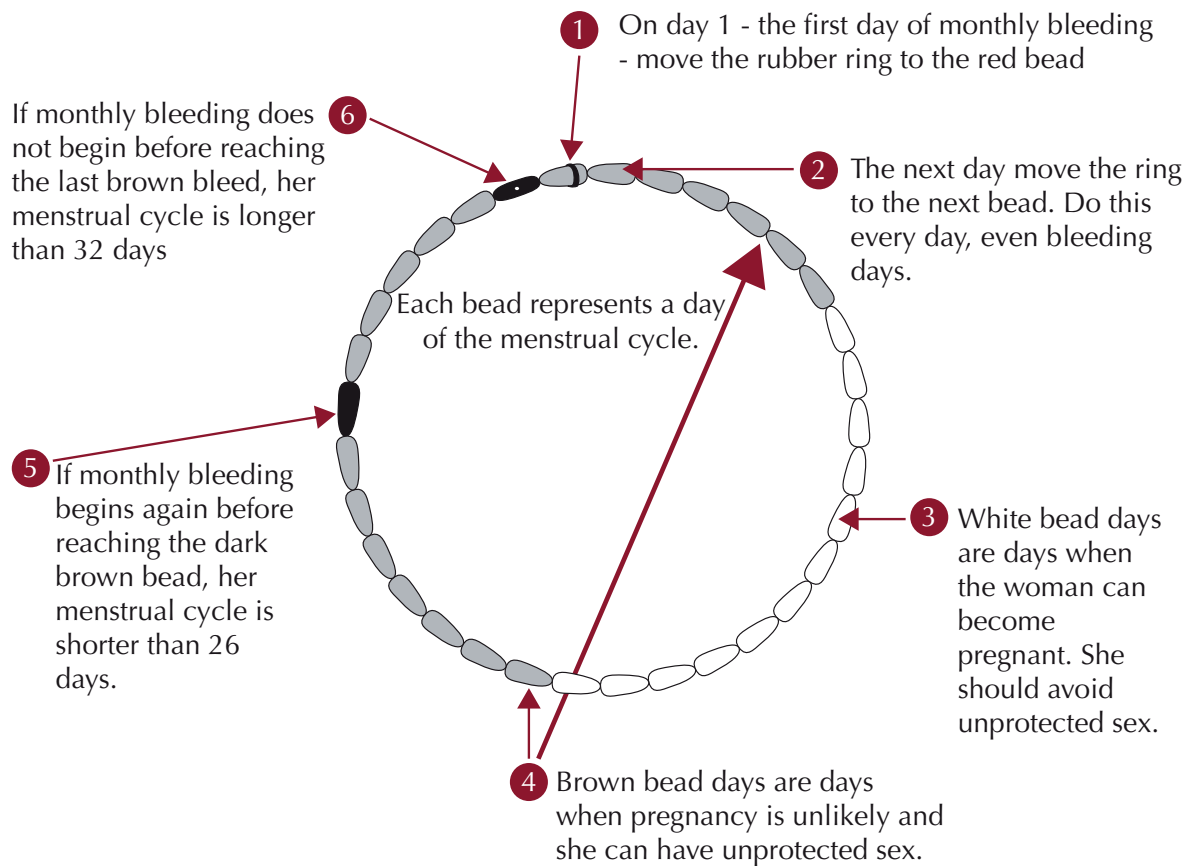
Once trained, a woman or couple usually can begin using calendar-based methods at any time. Give clients who cannot start immediately another method to use until they can start.	
<b>Woman's status</b>	When to start
<b>Having regular menstrual cycles</b>	<b>Any time of the month</b> <ul style="list-style-type: none"> <li>◆ No need to wait until the start of next monthly bleeding.</li> </ul>
<b>No monthly bleeding</b>	<ul style="list-style-type: none"> <li>◆ Delay calendar-based methods until monthly bleeding returns.</li> </ul>
<b>After childbirth (whether or not breastfeeding)</b>	<ul style="list-style-type: none"> <li>◆ Delay the Standard Days Method until she has had 3 menstrual cycles and the last one was 26–32 days long.</li> <li>◆ Regular cycles will return later in breastfeeding women than in women who are not breastfeeding.</li> </ul>
<b>After miscarriage or abortion</b>	<ul style="list-style-type: none"> <li>◆ Delay the Standard Days Method until the start of her next monthly bleeding, when she can start if she has no bleeding due to injury to the genital tract.</li> </ul>
<b>Switching from a hormonal method</b>	Delay starting the Standard Days Method until last three periods have been about a month apart (that means after 2 consecutive cycles are within the 26 to 32-day range). <ul style="list-style-type: none"> <li>◆ If she is switching from injectable, delay the Standard Days Method until injection's 90 day protection ends, and next three periods are about a month apart (that means two consecutive cycles are within 26-32 days)</li> </ul>
<b>After taking emergency contraceptive pills</b>	<ul style="list-style-type: none"> <li>◆ Delay the Standard Days Method until the start of her next monthly bleeding.</li> </ul>

### Explaining How to Use Calendar -Based Methods

#### Standard Days Method

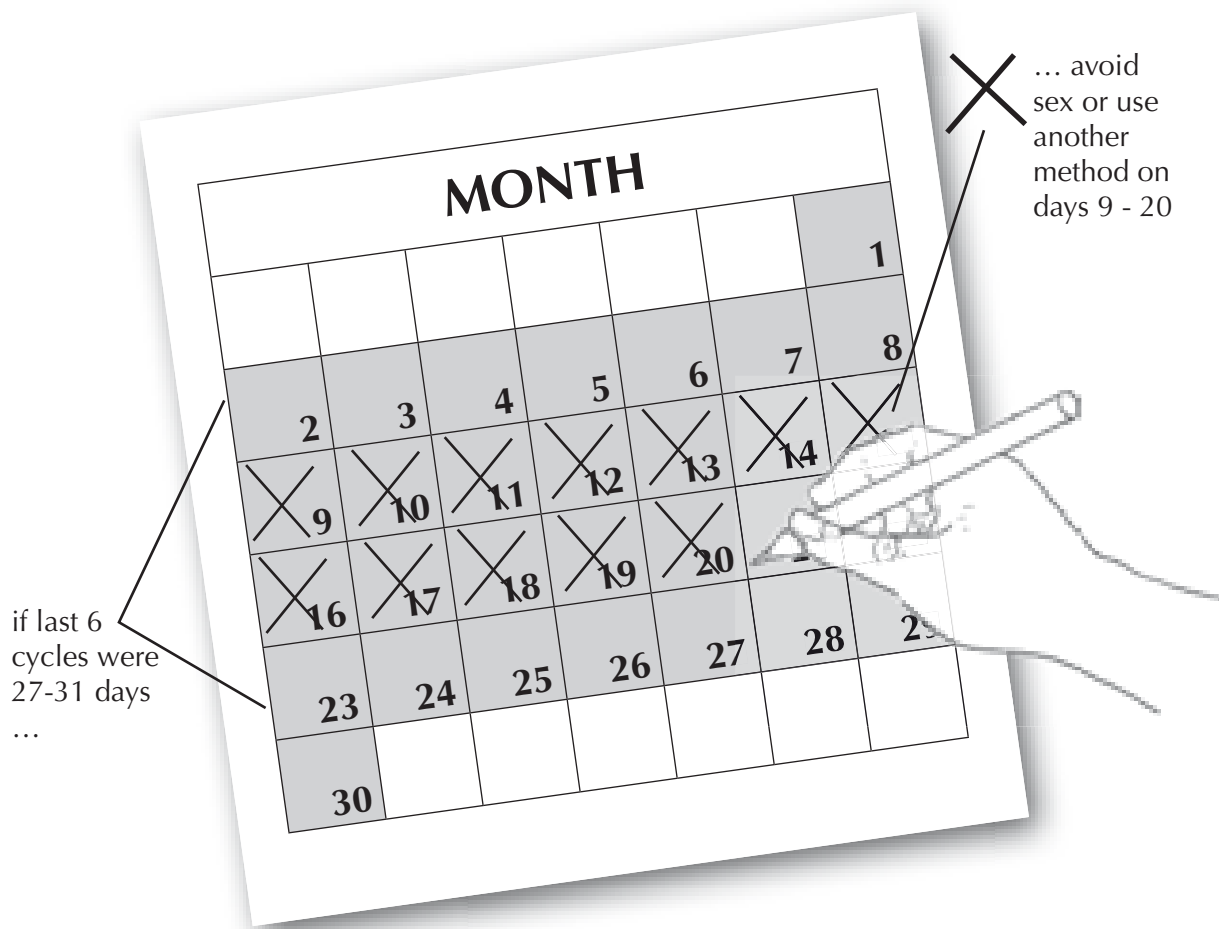
**IMPORTANT:** A woman can use the Standard Days Method if most of her menstrual cycles are 26 to 32 days long (women who get their periods about once a month fall within this range). If she has more than 2 longer or shorter cycles within a year, the Standard Days Method will not work for her and she needs to choose another method.

Keep track of the days of the menstrual cycle	A woman keeps track of the days of her menstrual cycle, counting the first day of monthly bleeding as day 1.
Avoid unprotected sex on days 8–19	Days 8 through 19 of every cycle are considered fertile days for all users of the Standard Days Method.  The couple avoids vaginal sex or uses condoms during days 8 through 19. They can also use withdrawal but this is less effective.  The couple can have unprotected sex on all the other days of the cycle—days 1 through 7 at the beginning of the cycle; and from day 20 until her next monthly bleeding begin.
Use memory aids if needed	The couple can use Cycle Beads, a colour-coded string of beads that indicates fertile and non fertile days of a cycle, or they can mark a calendar or use some other memory aid.



## Calendar Rhythm Method

<b>Keep track of the days of the menstrual cycle</b>	<ul style="list-style-type: none"> <li>◆ Before relying on this method, a woman records the number of days in each menstrual cycle for at least 6 months. The first day of monthly bleeding is always counted as day 1.</li> </ul>
<b>Estimate the fertile time</b>	<ul style="list-style-type: none"> <li>◆ The woman subtracts 18 from the length of her shortest recorded cycle. This tells her the estimated first day of her fertile time. Then she subtracts 11 days from the length of her longest recorded cycle. This tells her the estimated last day of her fertile time.</li> </ul>
<b>Avoid unprotected sex during fertile time</b>	<ul style="list-style-type: none"> <li>◆ The couple avoids vaginal sex, or uses condoms during the fertile time. They can also use withdrawal but this is less effective.</li> </ul>
<b>Update calculations monthly</b>	<ul style="list-style-type: none"> <li>◆ She should update these calculations each month, always using the 6 most recent cycles.</li> </ul> <p><b>Example:</b></p> <ul style="list-style-type: none"> <li>◆ If the shortest of her last 6 cycles was 27 days, <math>27 - 18 = 9</math>. She starts avoiding unprotected sex on day 9.</li> <li>◆ If the longest of her last 6 cycles was 31 days, <math>31 - 11 = 20</math>. She can have unprotected sex again on day 21.</li> <li>◆ Thus, she must avoid unprotected sex from day 9 through day 20 of her cycle.</li> </ul>



## Symptoms-based Methods

### Medical Eligibility for Symptoms-Based Methods

All women can use symptoms-based methods. No medical conditions prevent the use of these methods, but some conditions can make them harder to use effectively.

In the following situations use **caution** with symptoms-based methods:

- Recently had an abortion or miscarriage
- Menstrual cycles have just started or have become less frequent or stopped due to older age (Menstrual cycle irregularities are common in young women in the first several years after their first monthly bleeding and in older women who are approaching menopause. Identifying the fertile time may be difficult.)
- A chronic condition that raises her body temperature (for basal body temperature and symptothermal methods)

In the following situations delay starting symptoms-based methods:

- Recently gave birth or is breastfeeding (*Delay* until normal secretions have returned—usually at least 6 months after childbirth for breastfeeding women and at least 4 weeks after childbirth for women who are not breastfeeding. For several months after regular cycles have returned, use with *caution*.)
- An acute condition that raises her body temperature (for basal body temperature and Symptothermal methods)

- Irregular vaginal bleeding
- Abnormal vaginal discharge

In the following situations **delay or use caution** with symptoms-based methods:

- Taking any mood-altering drugs such as anti-anxiety therapies, antidepressants, anti-psychotics, long-term use of certain antibiotics, any nonsteroidal anti-inflammatory drug (such as aspirin, ibuprofen, or paracetamol), or antihistamines. These drugs may affect cervical secretions, raise body temperature, or delay ovulation.

## Providing Symptoms-Based Methods

### When to Initiate

Once trained, a woman or couple usually can begin using Sympto-based methods at any time. Women not using a hormonal method can practice monitoring their fertility signs before they start using Sympto-based methods. Give clients who cannot start immediately another method to use until they can start.	
Woman's Status	When to start
<b>Having regular menstrual cycles</b>	<b>Any time of the month</b> No need to wait until the start of next monthly bleeding.
<b>Having regular menstrual cycles</b>	<ul style="list-style-type: none"> <li>• Delay symptoms-based methods until monthly bleeding returns.</li> </ul>
<b>After childbirth</b> (whether or not breastfeeding)	<ul style="list-style-type: none"> <li>• She can start symptoms-based methods once normal secretions have returned.</li> <li>• Normal secretions will return later in breastfeeding women than in women who are not breastfeeding.</li> </ul>
<b>After miscarriage or abortion</b>	<ul style="list-style-type: none"> <li>• She can start symptoms-based method immediately with special counselling and support, if she has no infection-related secretions or bleeding due to injury to the genital tract.</li> </ul>
<b>Switching from a hormonal method</b>	<ul style="list-style-type: none"> <li>• She can start symptoms-based methods in the next menstrual cycle after stopping a hormonal method.</li> </ul>
<b>After taking emergency contraceptive pills</b>	<ul style="list-style-type: none"> <li>• She can start symptoms-based methods once normal secretions have returned.</li> </ul>

## Explaining How to Use Symptoms-Based Methods

### Two Day Method

**IMPORTANT:** If a woman has a vaginal infection or another condition that changes cervical mucus, the Two Day Method will be difficult to use.

<b>Check for secretions</b>	<ul style="list-style-type: none"> <li>The woman checks for cervical secretions every afternoon and/or evening, on fingers, underwear, or tissue paper or by sensation in or around the vagina.</li> <li>As soon as she notices any secretions of any type, colour, or consistency, she considers herself fertile that day and the following day.</li> </ul>
<b>Avoid sex or use another method on fertile days</b>	<ul style="list-style-type: none"> <li>The couple avoids vaginal sex or uses condoms on each day with secretions and on each day following a day with secretions. They can also use withdrawal but this is less effective.</li> </ul>
<b>Resume unprotected sex after 2 dry days</b>	<ul style="list-style-type: none"> <li>The couple can have unprotected sex again after the woman has had 2 dry days (days without secretions of any type) in a row.</li> </ul>

### Ovulation Method

**IMPORTANT:** If a woman has a vaginal infection or another condition that changes cervical mucus, this method may be difficult to use.

<b>Check cervical secretions daily</b>	<ul style="list-style-type: none"> <li>The woman checks every day for any cervical secretions on fingers, underwear, or tissue paper or by sensation in or around the vagina.</li> </ul>
<b>Avoid unprotected sex on days of heavy monthly bleeding</b>	<ul style="list-style-type: none"> <li>Ovulation might occur early in the cycle, during the last days of monthly bleeding, and heavy bleeding could make mucus difficult to observe.</li> </ul>
<b>Resume unprotected sex until secretions begin</b>	<ul style="list-style-type: none"> <li>Between the end of monthly bleeding and the start of secretions, the couple can have unprotected sex, but not on 2 days in a row. (Avoiding sex on the second day allows time for semen to disappear and for cervical mucus to be observed.)</li> <li>It is recommended that they have sex in the evenings, after the woman has been in an upright position for at least a few hours and has been able to check for cervical mucus.</li> </ul>
<b>Avoid unprotected sex when secretions begin and until 4 days after “peak day”</b>	<ul style="list-style-type: none"> <li>As soon as she notices any secretions, she considers herself fertile and avoids unprotected sex.</li> <li>She continues to check her cervical secretions each day. The secretions have a “peak day”—the last day that they are clear, slippery, stretchy, and wet. She will know this has passed when, on the next day, her secretions are sticky or dry, or she has no secretions at all.</li> <li>She should continue to consider herself fertile for 3 days after that peak day and avoid unprotected sex.</li> </ul>
<b>Resume unprotected sex</b>	<ul style="list-style-type: none"> <li>The couple can have unprotected sex on the 4th day after her peak day and until her next monthly bleeding begins.</li> </ul>



## Supporting the user

### Reasons to Return

No routine return visit is required.

- Providers should invite a woman or couple to meet with them a few times during the first few cycles if they want more help.
- Assure every client that she is welcome to come back any time—for example, if she has problems, questions, or wants another method; she has any major change in health status; or thinks she might be pregnant.

Also if:

- She is having difficulty identifying her fertile days.
- She is having trouble avoiding sex or using another method on the fertile days. For example, her partner does not cooperate.

## Helping Continuing Users

### Helping Clients at Any Visit

- Ask clients how they are doing with the method and whether they are satisfied. Ask if they have any questions or anything to discuss.
- Ask especially if they are having difficulty identifying her fertile days or trouble avoiding unprotected sex on the fertile days.
- Check whether the couple is using the method correctly. Review observations or records of fertility signs. If needed, plan for another visit.
- Ask a long-term client if she has had any new health problems since her last visit. Address problems as appropriate.
- Ask a long-term client about major life changes that may affect her needs—particularly plans for having children and STI and HIV risk.
- Follow up as needed.

## Managing any problems

### Problems with Use

- Problems with fertility awareness methods affect women's satisfaction and use of the method. They deserve the provider's attention. If the client reports any problems, listen to her concerns and give her advice.
- Offer to help the client choose another method—now, if she wishes, or if problems cannot be overcome.

### Inability to abstain from sex during the fertile time

- Discuss the problem openly with the couple and help them feel at ease not embarrassed.
- Discuss possible use of condoms, withdrawal, or sexual contact without vaginal sex during the fertile time.
- If she has had unprotected sex in the past 5 days she can consider ECPs (see Emergency Contraceptive Pills).

### **Cycles are outside the 26–32 day range for Standard Days Method**

- If she has 2 or more cycles outside the 26 to 32 day range within any 12 months, suggest she use the calendar rhythm method or a symptoms-based method instead.

### **Very irregular menstrual cycles among users of calendar-based methods**

- Suggest she use a symptoms-based method instead

### **Difficulty recognizing different types of secretions for the ovulation method**

- Counsel the client and help her learn how to interpret cervical secretions.
- Suggest she use the Two Day Method, which does not require the user to tell the difference among types of secretions.

### **Difficulty recognizing the presence of secretions for the Two Day Method**

- Provide additional guidance on how to recognize secretions.
- Suggest she use a calendar-based method instead.

## CHAPTER 11:

# IMPLANTS

### Overview:

Implants are small flexible rods that are placed just under the skin of the upper arm. After being inserted, they provide pregnancy protection for up to 3 to 5 years, depending on the type of implant. Implants are more than 99% effective and clients don't need to do or remember anything once they are in place. Implants are well tolerated, safe, convenient and offer rapid return to fertility upon removal. Bleeding changes are likely to occur, although the nature of the change in any individual woman is not predictable. Changes may include prolonged bleeding, frequent bleeding, irregular bleeding, infrequent bleeding, and amenorrhea, which are not harmful. However, such bleeding is the main reason that women discontinue use of implants; thus counseling prior to insertion, including exploration about how such bleeding might be perceived by the woman and her family is critical for quality service provision and method continuation. A woman cannot start or stop implants on her own. The procedures for insertion and removal are quick and simple, but require a provider to be trained in both. Careful (not too deep) insertion facilitates easy removal.

### This chapter covers information related to implants provision, including:

- Definition
- Mechanism of action
- Characteristics
- Correcting misconceptions
- Screening for eligibility
- How to insert and remove implants
- Infection prevention measures
- Management of side effects

## Advance Preparation

- Implants
- Source of clean running water, soap
- Light source
- Table with large armrest or adjoining side table
- Antiseptic solution
- Pre-sterilised instrument tray
- Local anaesthetic Lignocaine 1% without epinephrine (if only 2% is available also need sterile water).
- Sterile needle and syringe at least 2" (2-5 ml).
- Sterile scalpel #11 or #15 (for removal of implants and optional for two rod insertion).
- Trocar #10 with obturator for two rod insertion (plunger).
- Ordinary bandages/first aid plaster.
- Bandage spray (optional)
- Sterile gauze and compresses
- Emergency drugs such as adrenaline
- Blood pressure machine
- Supplies for infection prevention (see chapter 3)
- Sterile gloves

## Providing Information about Implants

### What are Implants?

Implants are small, thin, flexible, plastic rods, each about the size of a matchstick, that release a small, steady amount of progestin (like the natural hormone, progesterone) into a woman's body.

Implants do not contain oestrogen, and so can be used throughout breastfeeding and by women who cannot use methods with oestrogen. A specifically trained provider performs a minor surgical procedure to place the implant(s) under the skin on the inside of a woman's upper arm.

### Types of implants:

**SINGLE ROD**, which is labelled effective for 3 years (one type is used in Tanzania is Implanon):

This is a non biodegradable rod measuring 4 cm in length and 2mm in diameter

The rod contains 68 mg of etonogestrel (ENG), the active metabolite of desogestrel. It provides a controlled release of the progestin (about 30 micrograms per day)

It is supplied pre-loaded in a sterile, disposable applicator for single use. Insertion does not require an incision on the skin



**TWO RODS**, which are labelled effective for 4 years (Sino-Implant) or 5 years (Jadelle):

1. Jadelle

Consists of 2 small rods that have a core of an equal mixture of levonorgestrel (LNG) and a silicone elastomer

It is non-biodegradable and measures 4.3 cm in length and 2.5 mm in diameter and each rod contains 75 mg of LNG, making a total of 150 mg.



2. Sino-Implant (II)

A Sino-Implant is a generic version of Jadelle (with the same mechanism of action) available at a 70 percent lower cost. Generic production of implants has reduced prices dramatically.

Sino-implant (II) is a sub dermal contraceptive implant manufactured in China by Shanghai Dahua Pharmaceutical Co., Ltd. The product is marketed in Kenya under the trade name Zarin™. It has an annual pregnancy rate below 1 percent. The product is composed of two thin, flexible, silicone rods, each containing 75 mg levonorgestrel. Each rod consists of a drug core and an external medical silastic tube sealed at both ends with medical adhesive. It is currently labelled for four years of use. It is a low-cost, safe, and effective contraceptive implant.



The failure rates, discontinuation rates and annual costs of implants are much lower than those of other hormonal contraceptives (Table below).

Method	Pregnancy rate - year 1	Discont. rate - year 1	Duration of use	Cost per year *
Sterilization	< 1%	0%	Permanent	?
IUD	< 1%	22%	10 years	<\$ 0.10
Sino - implant	< 1%	16%	4 years	\$ 1.75
Jadelle	< 1%	16%	5 years	\$ 6.00
Implanon	< 1%	16%	3 years	\$ 6.65
DMPA	3%	44%	3 months	\$ 3.80
OCs	8%	32%	1 month	\$ 3.50

### Mechanism of Action of Implants

Work primarily by:

- Thickening cervical mucus (this blocks sperm from meeting an egg)
- Disrupting the menstrual cycle, including preventing the release of eggs from the ovaries (ovulation)

## Effectiveness of Implants

Implants are among the most effective of methods and are long-acting.

- Less than 1 pregnancy occurs per 100 women using implants over the first year (5 per 10,000 women).
- A small risk of pregnancy remains beyond the first year of use and continues as long as the woman is using implants.
- Over 5 years of two-rods implants use: about 1 pregnancy per 100 women
- Over 3 years of one-rod implant use: less than 1 pregnancy per 100 women (1 per 1,000 women)
- Jadelle implants start to lose effectiveness sooner for heavier women: for women weighing 80 kg or more, they become less effective after 4 years of use. These users may want to replace their implants sooner.

## Characteristics of Implants

Advantages:

- Highly effective and safe
- Provide multiple years of protection
- Convenient and private
- Independent of intercourse
- Fertility returns without delay after implants are removed
- Have no adverse effects on the quality and quantity of breast milk
- Help protect against symptomatic pelvic inflammatory disease and iron-deficiency anaemia

Side effects

- Cause changes in menstrual bleeding patterns, including
  - In the first few months: irregular bleeding, lighter bleeding, fewer days of bleeding, infrequent bleeding or no monthly bleeding
  - After about one year of use: lighter bleeding and fewer days of bleeding, irregular bleeding or infrequent bleeding

Other side effects may include:

- Headaches
- Abdominal pain
- Weight change
- Dizziness
- Nausea
- Breast tenderness
- Mood change
- Acne (can worsen or improve)
- Enlarged ovarian follicles

Complications (generally uncommon)

- Infection at insertion site (if infections occur they will do so within the first 2 months after insertion)
- Difficult removal (rare if implants were properly inserted and the provider is skilled at removal)
- Expulsion of implant (rare; most often occurs within the first 4 months after insertion)

**Note:**

Single rod users (Implanon) are more likely to have infrequent or no monthly bleeding than irregular bleeding lasting more than 8 days.

While some of the side effects may be unpleasant, they are not harmful to woman's health.

## Correcting Misconceptions about Implants

Implants:

- Stop working once they are removed. Their hormones do not remain in a woman's body
- Can stop monthly bleeding, but this is not harmful. It is similar to not having monthly bleeding during pregnancy. Blood is not building up inside the woman
- Do not make women infertile
- Do not move to other parts of the body
- Substantially reduce the risk of ectopic pregnancy.

## Who Can Use Implants

Nearly all women can use implants safely and effectively, including women who:

- Have or have not had children
- Are not married
- Are of any age, including adolescents and women over 40 years of age
- Have just had an abortion, or ectopic pregnancy
- Smoke cigarettes, regardless of woman's age or number of cigarettes smoked
- Are breastfeeding (starting as soon as 6 weeks after childbirth)
- Have anaemia now or in the past
- Have varicose veins
- Are infected with HIV, whether or not on antiretroviral therapy

Women can begin using implants:

- Without a pelvic examination
- Without any blood tests or other routine laboratory tests
- Without cervical cancer screening
- Without a breast examination
- Even when a woman is not having monthly bleeding at the time, if it is reasonably certain she is not pregnant (see Pregnancy Checklist in chapter 3)

## Screening for Medical Eligibility for Implants

Ask the client the questions below about known medical conditions. Examinations and tests are not necessary. If she answers NO to all of the questions, then she can have implants inserted if she wants. If she answers YES to a question, follow the instructions. In some cases she can still start using implants.

**1. Are you breastfeeding a baby less than 6 weeks old?**

No  Yes

If YES, she can start using implants as soon as a baby is 6 weeks old

**2. Do you have liver disease, a liver infection, or liver tumour? (Check if woman's eyes or skin unusually yellow, which are signs of jaundice)**

No  Yes

If she reports serious active liver disease (jaundice, severe cirrhosis, liver tumour), do not provide implants. Help her choose a method without hormones.

**3. Do you have a serious problem now with a blood clot in your legs or lungs?**

No  Yes

If she reports a current blood clot (not superficial clots), do not provide implants. Help her choose a method without hormones.

**4. Do you have vaginal bleeding that is unusual for you?**

No  Yes

If she has unexplained vaginal bleeding that suggests pregnancy or an underlying medical condition, implants could make diagnosis and monitoring of any treatment more difficult. Help her choose a method to use while being evaluated and treated (not progestin-only injectables, or a copper-bearing or hormonal IUCD). After treatment, re-evaluate for use of implants.

**5. Do you have or have you ever had breast cancer?**

No  Yes

If YES, do not provide implants. Help her choose a method without hormones. Be sure to explain the health benefits and risks and the side effects of the method that the client will use. Also, point out any conditions that would make the method inadvisable, when relevant to the client.

**Note:**

While medications such as rifampicin, barbiturates, carbamazepine, oxcarbazepine, phenytoin, primidone or topiramate were thought to make implants less effective, they are now category 1 or 2 in the WHO Family Planning Handbook.



### Using Clinical Judgment in Special Cases

Usually, a woman with any of the conditions listed below should not use implants. In special circumstances, however, when other, more appropriate methods are not available or acceptable to her, a qualified provider who can carefully assess a specific woman's condition and situation may decide that she can use implants. The provider needs to consider the severity of her condition and, for most conditions, whether she will have access to follow-up.

- Breastfeeding and less than 6 weeks since giving birth
- Current blood clot in deep veins of legs or lungs
- Unexplained vaginal bleeding before evaluation for possible serious underlying condition.
- Had breast cancer more than 5 years ago, and it has not returned
- Severe liver disease, infection, or tumour.

### Implants for Women with HIV

- Women who are infected with HIV, have AIDS, or are on antiretroviral (ARV) therapy can safely use implants
- Urge these women to use condoms along with implants. Used consistently and correctly, condoms help prevent transmission of HIV and other STIs

### Providing Contraceptive Implants

**IMPORTANT:** A woman can start using implants at any time she wants if it is reasonably certain she is not pregnant. To be reasonably certain she is not pregnant, use the Pregnancy Checklist (see chapter 6, Screening)

Woman's situation	When to start
Having menstrual cycles or switching from a non hormonal method	<p>Any time of the month</p> <p>If she is starting within 7 days after the start of her monthly bleeding (within 5 days for single-rod method), there is no need for a backup method</p> <p>If it is more than 7 days after the start of her monthly bleeding (more than 5 days for single-rod method), she can have implants inserted any time it is reasonably certain she is not pregnant. She will need a backup method for the first 7 days after insertion</p> <p>If she is switching from an IUCD, she can have implants inserted immediately (copper-bearing IUCD, switching from an IUCD to another method)</p>
Switching from a hormonal method	<p>Immediately, if she has been using the hormonal method consistently and correctly or if it is otherwise reasonably certain she is not pregnant. No need to wait for her next monthly bleeding. No need for a backup method</p> <p>If she is switching from injectables, she can have implants inserted when the repeat injection would have been given. No need for a backup method.</p>

Fully or nearly fully breastfeeding, less than 6 months after giving birth	<p>If she gave birth less than 6 weeks ago, delay insertion until at least 6 weeks after giving birth</p> <p>If her monthly bleeding has not returned, she can have implants inserted any time between 6 weeks and 6 months. No need for a backup method</p> <p>If her monthly bleeding has returned, she can have implants inserted as advised for women having menstrual cycles (see above)</p>
Fully or nearly fully breastfeeding, more than 6 months after giving birth	<p>If her monthly bleeding has not returned, she can have implants inserted any time it is reasonably certain she is not pregnant. She will need a backup method for the first 7 days after insertion</p> <p>If her monthly bleeding has returned, she can have implants inserted as advised for women having menstrual cycles (see above)</p>
Partially breastfeeding, less than 6 weeks after giving birth	Delay inserting implants until at least 6 weeks after giving birth
Partially breastfeeding, more than 6 weeks after giving birth	<p>If her monthly bleeding has not returned, she can have implants inserted any time it is reasonably certain she is not pregnant. She will need a backup method for the first 7 days after insertion</p> <p>If her monthly bleeding has returned, she can have implants inserted as advised for women having menstrual cycles (see above)</p>
Not breastfeeding, less than 4 weeks after giving birth	She can have implants inserted at any time. No need for a backup method
Not breastfeeding, more than 4 weeks after giving birth	<p>If her monthly bleeding has not returned, she can have implants inserted any time it is reasonably certain she is not pregnant. She will need a backup method for the first 7 days after insertion</p> <p>If her monthly bleeding has returned, she can have implants inserted as advised for women having menstrual cycles (see above).</p>
No monthly bleeding (not related to childbirth or breastfeeding)	She can have implants inserted any time it is reasonably certain she is not pregnant. She will need a backup method for the first 7 days after insertion.
After miscarriage or abortion	<p>Immediately. If implants are inserted within 7 days after first- or second-trimester miscarriage or abortion, no need for a backup method.</p> <p>If it is more than 7 days after first- or second-trimester miscarriage or abortion, she can have implants inserted any time it is reasonably certain she is not pregnant. She will need a backup method for the first 7 days after insertion.</p>
After taking emergency contraceptive pills (ECPs)	Implants can be inserted within 7 days after the start of her next monthly bleeding (within 5 days for single-rod implant) or any other time it is reasonably certain she is not pregnant. Give her a backup method, or oral contraceptives to start the day after she finishes taking the ECPs, to use until the implants are inserted

## Counselling About Side Effects

**IMPORTANT:** Thorough counselling about bleeding changes and other side effects must come before inserting implants. Counselling about bleeding changes may be the most important help a woman needs to keep using the method.

### Describe the most common side effects

- Changes in her bleeding pattern:
  - Irregular bleeding that lasts more than 8 days at a time over the first year
  - Regular, infrequent, or no bleeding at all later.
- Headaches, abdominal pain, breast tenderness, and possibly other side effects

### Explain about these side effects

- Side effects are not signs of illness
- Most side effects usually become less or stop within the first year
- Common, but some women do not have them
- Client can come back for help if side effects bother her

## Inserting Implants

Re-Confirm the client's choice of the implant and explain procedure

A woman who has chosen implants needs to know what will happen during insertion. She needs to know that inserting implants usually takes only a few minutes but can sometimes take longer, depending on the circumstances. Related complications are rare and also depend on the skill of the provider and type of implant. Determine client's allergies to anaesthetic agent or related drugs through history. The woman receives an injection of local anaesthetic under the skin of her arm to prevent pain while the implants are being inserted. The provider inserts the implants just under the skin. The woman may feel some pressure or tugging. After all implant(s) are inserted, the provider closes the puncture or incision with an adhesive bandage. Stitches are not needed.

### Explain Insertion Procedure to the Client

1. The provider uses proper infection-prevention procedures
2. The woman receives an injection of local anaesthetic under the skin of her arm to prevent pain while the implants are being inserted. This injection may sting. She stays fully awake throughout the procedure.
3. The provider makes a small incision in the skin on the inside of the upper arm.
4. The provider inserts the implants just under the skin. The woman may feel some pressure or tugging.
5. After all implants are inserted, the provider closes the incision with an adhesive bandage. Stitches are not needed. The incision is covered with a dry cloth and the arm is wrapped with gauze.

### Clinical procedure for insertion of the implants:

Learning to insert and remove implants requires training and practice under direct supervision. Take history and do physical examination, including a gynecologic examination (if necessary), before IMPLANT insertion. Ensure that the client understands the risks and benefits of IMPLANT before insertion. Have the client review and complete a consent form and maintain it with the

client's card. Exclude pregnancy before insertion. All healthcare providers must receive training before inserting or removing implants. Proper implant insertion will facilitate removal.

### Preparation and anaesthesia:

1. Arrange supplies and instruments so that they are easily accessible
2. Have an assistant open the sterile equipment tray
3. Wash hands with soap and water and dry with sterile towel/gauze or air dry
4. Put on sterile gloves and use sterile gauze to remove powder from the gloves
5. Have an assistant open the sterile implant package by pulling apart the sheets of the pouch, allowing the content to fall on the sterile cloth/tray.

## INSTRUCTIONS FOR INSERTION AND REMOVAL OF CONTRACEPTIVE IMPLANTS

The basis for successful use and subsequent removal of IMPLANT/S is a correct and carefully performed subdermal insertion of the rod/s in accordance with the instructions. If the implant is placed improperly leading to deep location or migration, it will be more difficult to remove than a correctly placed subdermal implant. All healthcare providers performing insertions and removals of IMPLANTS must receive instruction and training, and receive supportive supervision for an appropriate length of time.

### Insertion of implant/s:

Insertion of implant/s should be done under aseptic conditions and is performed with a specially designed applicator (cannula, obturator/plunger and needle with double angled bevel). The use of this applicator differs substantially from that of a classical syringe.

The procedure used for insertion of implant/s is opposite to giving an injection. When inserting implant/s the obturator (plunger) must remain fixed while the cannula (needle) is retracted from the arm. For normal injections the plunger is pushed and the body of the syringe remains fixed. Do not push the obturator. Place the IMPLANT/S subdermally so that both you and your client are able to feel rod/s under her skin after placement.

### Insertion of a single rod implant

An applicator and its parts are shown in the following diagrams (Figures 3a and 3b).

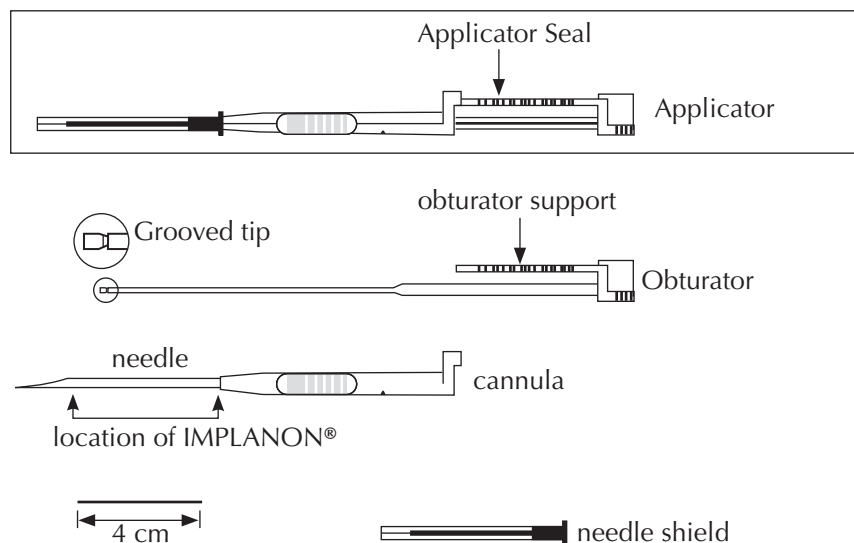
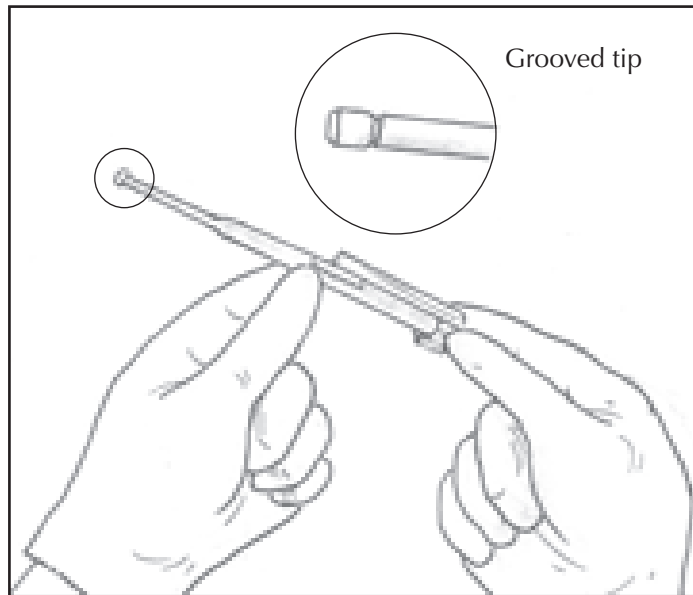


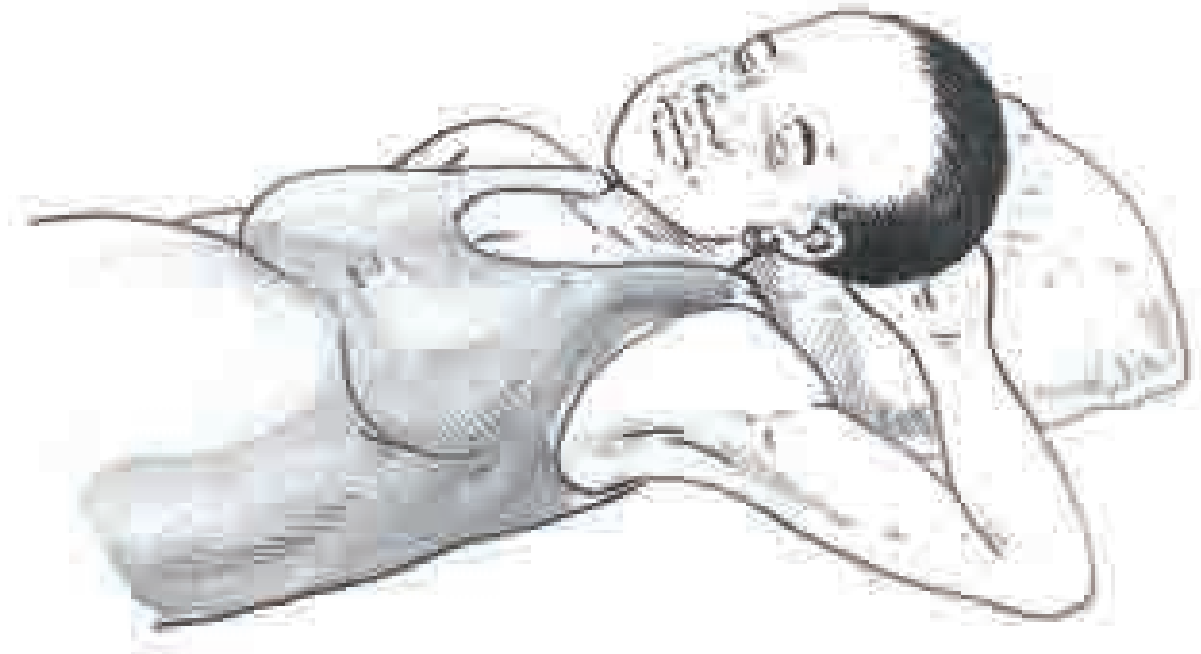
Figure 3a: (not to scale)



**Figure 3b**

Grooved tip of obturator (enlarged)

1. Confirm that the client does not have allergies to implants as well as the antiseptic and anesthetic to be used during insertion.
2. Have the client lie on her back on the examination table with her non-dominant arm flexed at the elbow and externally rotated so that her wrist is parallel to her ear or her hand is positioned next to her head (Figure 4).



**Figure 4**

3. Identify the insertion site, which is at the inner side of the non-dominant upper arm about 8-10 cm (3 to 4 inches) above the medial epicondyle of the humerus (Fig. 5). The implant should be inserted subdermally just under the skin to avoid the large blood vessels and nerves that lie deeper in the subcutaneous tissue of the sulcus between the biceps and triceps muscles.

4. Identify the insertion site as shown in Figure 5.

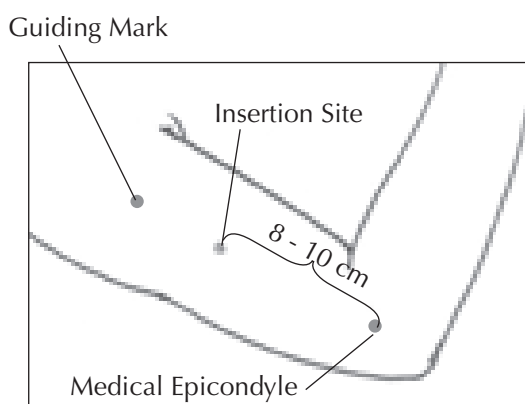


Figure 5

5. Clean the insertion site with an antiseptic solution.
6. Anesthetize the insertion area (for example, with anaesthetic spray or by injecting lignocaine just under the skin along the planned insertion tunnel). Use a syringe with a long, thin needle 4-4.5cm long to draw up 3-4 ml of local anaesthetic

Insert the tip of the needle under the skin and release a very small amount of anaesthetic to create a wheal

Without removing the needle from under the skin, give a local anaesthesia, lignocaine 1% without adrenalin, subcutaneously at the area of insertion. The recommended amount is up to 2 ml of 1 % lignocaine for single-rod implant. Using the anaesthetic needle make a channel just beneath the skin. This will ease the entry of the rod under the skin. Test the skin by pinching for effectiveness of the anaesthesia

7. Carefully remove the implant applicator from its blister. Keep the shield on the needle and look for the implant, seen as a white cylinder inside the needle tip.
8. If you don't see the implant rod, tap the top of the needle shield against a firm surface to bring the implant into the needle tip e.g. tapping against the plastic part of the cannula.
9. Following visual confirmation, lower the implant rod back into the needle by tapping it back into the needle tip. Then remove the needle shield, while holding the applicator upright.
10. Note that the rod can fall out of the needle. Therefore, after you remove the needle shield, keep the applicator in the upright position until the moment of insertion. This prevents the implant from dropping out.
11. Keep the implant needle and rod sterile. If contamination occurs, use a new package of implant with a new sterile applicator.
12. Apply counter-traction to the skin around the proposed insertion site (Figure 6).
13. At a slight angle (not greater than 20°), insert only the tip of the needle, with the bevelled side up, into the insertion site (Figure 7).

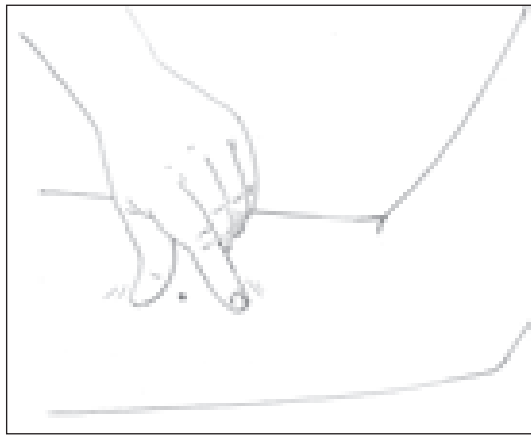


Figure 6

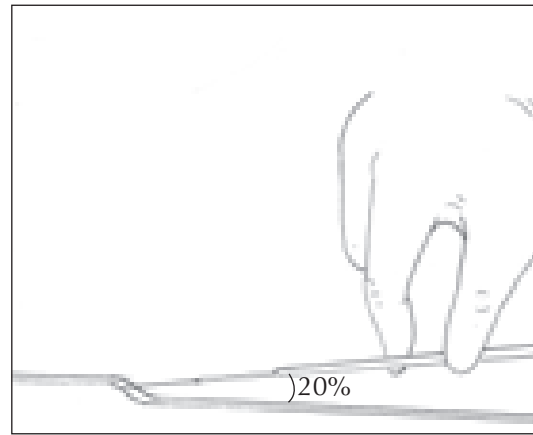


Figure 7

14. Lower the applicator to a horizontal position. Lift the skin up with the tip of the needle, but keep the needle in the subdermal connective tissue (Figure 8).
15. While “tenting” (lifting) the skin, gently insert the needle to its full length. Keep the needle parallel to the surface of the skin during insertion (Figure 9).

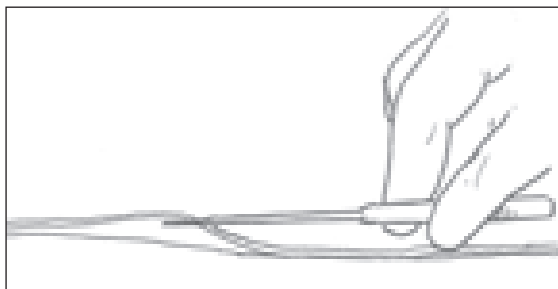


Figure 8

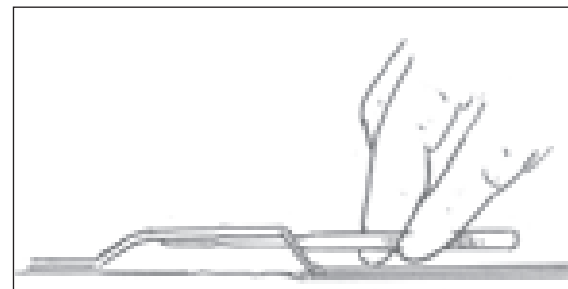


Figure 9

**Note:** If implant is placed too deeply, the removal process can be difficult or impossible. If the needle is not inserted to its full length, the implant may protrude from the insertion site and fall out.

16. Break the seal of the applicator by pressing the obturator support (Figure 10).
17. Turn the obturator 90° in either direction with respect to the needle (Figure 11).

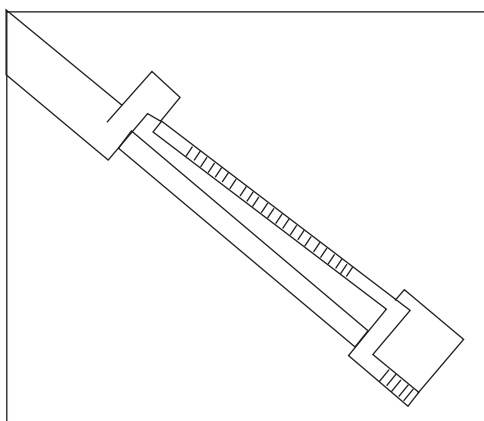


Figure 10

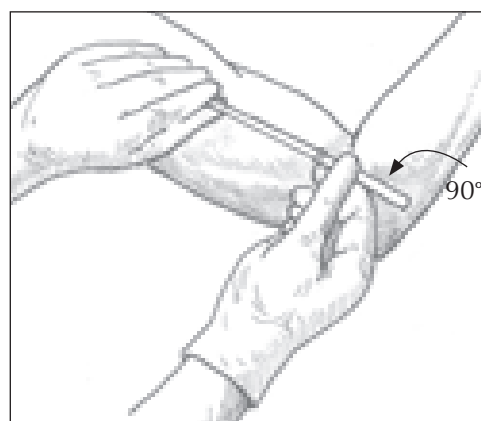


Figure 11

18. While holding the obturator fixed in place on the arm, fully retract the cannula (Figure 12). Implant will be left in the correct subdermal position. Do not simultaneously retract the obturator and cannula from the client’s arm.

19. Confirm that implant has been inserted by checking the tip of needle for the absence of implant. After implant insertion, the grooved tip of the obturator will be visible inside the needle (Figure 13). Do not confuse the protruding end of the obturator (plunger) with the implant (same colour). The applicator is for single use only and must be properly disposed of.

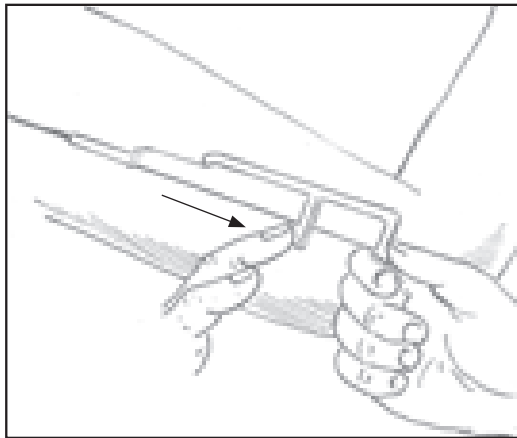


Figure 12

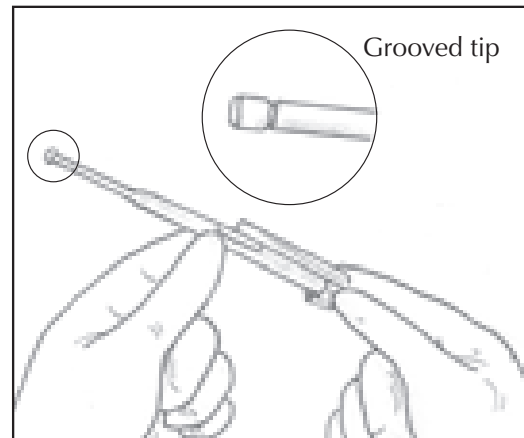


Figure 13

20. Always verify the presence of the implant in the client's arm immediately after insertion; by palpating both ends of the implant; you should be able to confirm the presence of the 4 cm rod.
21. If you cannot feel the implant as a 4 cm long rod, confirm its presence using other methods. Suitable methods to locate the single-rod implant are: ultrasound (US) with a high-frequency linear array transducer (10 MHz or greater) or magnetic resonance imaging (MRI). Please note that the implant rod is not radio-opaque and cannot be seen by X-ray or CT scan. If ultrasound and MRI fail refer for procedures for measuring ENG blood levels. Until you confirm proper implant insertion, your client must use a non-hormonal contraceptive method.
22. Place a small adhesive bandage over the insertion site. Apply a pressure bandage with sterile gauze to minimize bruising. The client may remove the pressure bandage in 24 hours and the small bandage over the insertion site in three to five days. Request that the client palpate rod.
23. Complete the USER CARD and give it to the client to keep. Also, complete the Client Card and affix it to the client's medical record.
24. The applicator is for single use only. Dispose of the applicator in accordance with the national guidelines for handling of hazardous waste.

### Insertion of two rods implant –Jadelle and Sino-Implant

Generally, same descriptions of the single rod insertion apply

1. Give local anaesthesia using lignocaine 1% without adrenalin, subcutaneously at the area of insertion (up to 4cc). Anesthetize two areas about 4.5 cm long, to mimic the V shape of the implantation site. Make a small, shallow incision about 2 mm long (alternatively, the trocar may be inserted directly through the skin without making an incision with the scalpel). Do not make a deep incision.
2. Pick up the #10 trocar.



3. Insert the point of the trocar through the incision at a shallow angle, tenting the skin. Starting at either the right or the left end of the V-like pattern, move the trocar forward, stopping as soon as the point is completely beneath the skin (2-3 mm past the end of the bevel).
4. To keep the implants on a superficial plane, tilt the trocar upwards toward the surface of the skin.
5. Advance the trocar gently under the skin to the mark nearest the hub of the trocar (1). Do not force the trocar, and if resistance is encountered, try another direction. The trocar should be shallow enough so that it can be readily followed with a finger. It should visibly raise the skin at all times. Passage of the trocar will be smooth if it is in a proper shallow plane.
6. When mark (1) is reached, the trocar is in position to accept an implant.
7. Ask the client to count the implants with you as you insert them.
8. Remove the plunger from the trocar and load the first implant rod into the trocar cannula (barrel), either using the thumb and forefinger or tweezers. If the implants are picked up by hand, be sure the sterile gloves are free of powder.
9. Push the implant rod down to the top of the hub.
10. Push the implant gently with the plunger towards the tip of the trocar cannula until you feel resistance but never force the plunger.
11. Hold the plunger firmly in place with one hand.
12. Withdraw the trocar cannula (barrel) back out of the incision to the mark closest to the trocar tip (2). It is important to keep the plunger steady and not to push the implant rod into the tissue. The implant should now be lying beneath the skin, free of the trocar. It must be free of the trocar to avoid being cut as the trocar is moved to insert the other implant rods.
13. To place the next implant rod, do not completely remove the trocar – mark (2) indicates how much of the trocar should remain under the skin. Swivel the trocar about 15 degrees, establishing a V-like placement pattern.
14. Hold the last implant rod you inserted with one finger. Put another finger next to the first and use it as a guide, while you advance the trocar to the mark (1) near the hub. This will ensure a suitable distance between implant rods and will keep the trocar from puncturing any of the already inserted implant rods.
15. When mark (1) is reached, remove the plunger from the trocar cannula (barrel), load the second implant rod into the trocar cannula (barrel) and proceed as before (steps 9 to 14). Remember that the implant rods should form a “V” so that the two rods are at an angle of about 15 degrees).
16. As you proceed, make sure that the ends of the implant rods nearest to you are not less than 5mm from the incision. This distance will prevent expulsions.
17. Withdraw the trocar after the last implant rod is in place. Press down on the incision with a gauze for a minute to stop bleeding. Palpate the implant rods to make sure that both have been inserted.
18. Clean the area around incision with antiseptic.
19. Bring the edges of the incision together and use a butterfly bandage or ordinary plaster band-aid to close and cover the incision.
20. Cover the insertion area with a dry compress and wrap enough gauze around the arm to ensure haemostasis.

## Removing the Implants

Before initiating the removal procedure, the healthcare provider may consult the USER CARD that is kept by the client and/or the Client Card. The arm in which the implant(s) is/are located should be indicated on the USER CARD and the Client Card. Implant(s) should have been inserted in the medial aspect of the upper non-dominant arm. Localize implant(s) by palpation. If implant(s) cannot be palpated, use either ultrasound with a high-frequency linear array transducer (10 MHz or greater) or magnetic resonance imaging to localize the implant. Consider conducting difficult removals with ultrasound guidance. Only remove a non-palpable implant once the location of the implant(s) has been established. If these imaging methods fail, refer to a qualified provider.

The following equipment is needed for removal

- An examination table for the client to lie on
  - Powder-free sterile gloves, antiseptic solution, permanent marker (optional)
  - Local anesthetic, needles, and syringe
  - Sterile scalpel and forceps (straight and curved mosquito)
  - Skin closure, sterile gauze, adhesive bandage and pressure bandages
1. Implant(s) must only be removed by a healthcare provider who has been instructed and trained in the implant(s) removal technique.
  2. The arm in which the implant(s) is/are located should be indicated on the USER CARD and the Client Card. IMPLANT/S should be in the medial aspect of the upper non-dominant arm.
  3. After confirming that the client does not have any allergies to the antiseptic, wash the client's arm and apply an antiseptic. Locate the implant(s) by palpation and note the end closest to the elbow (Figure a).



Figure a

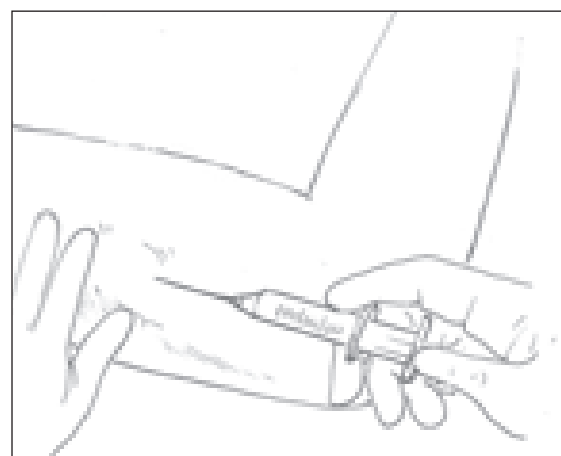


Figure b

4. After determining the absence of allergies to the anesthetic agent or related drugs, anesthetize the arm, for example, with 0.5 to 1 cc 1% lignocaine without epinephrine at the site where the incision will be made (near the tip of the implant(s) that is closest to the elbow) (Figure b). Be sure to inject the local anesthetic under the implant(s) to keep the implant close to the skin surface.
5. Make a 2-3 mm incision in the longitudinal direction of the arm at the tip of the implant closest to the elbow (Figure c).

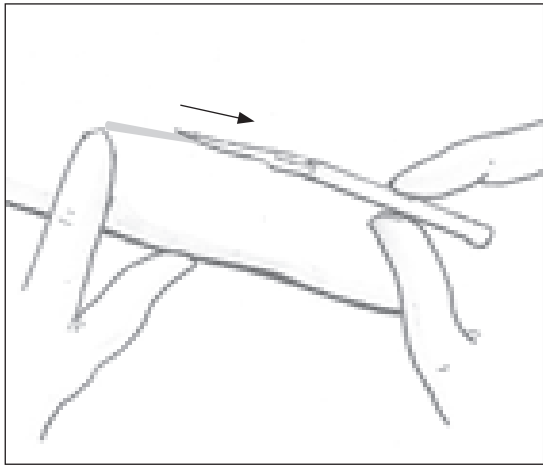


Figure c

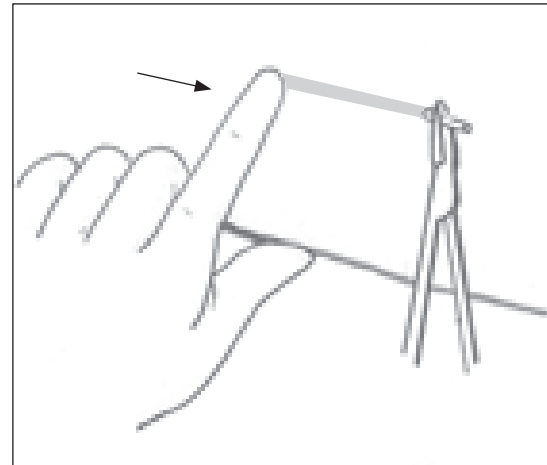


Figure d

6. Gently push the implant(s) toward the incision until the tip is visible. Grasp the implant with forceps (preferably curved mosquito forceps) and pull it out gently (Figure d).
7. If the implant(s) is encapsulated, make an incision into the tissue sheath and then remove it with a forceps (Figures e and f).

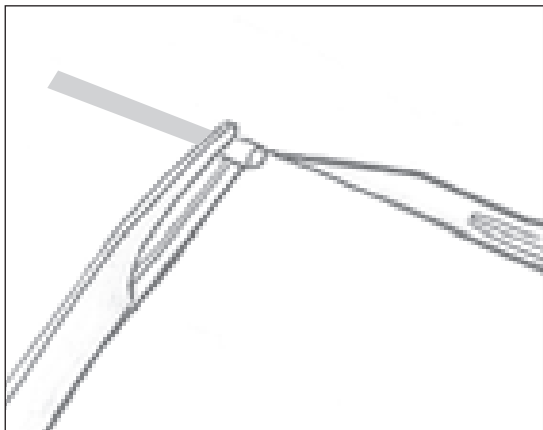


Figure e

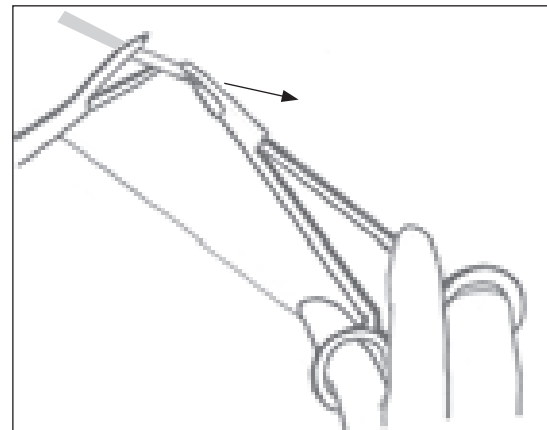


Figure f

8. If the tip of the implant is still not visible after gently pushing it towards the incision (as in step 6), gently insert a forceps into the incision and grasp the implant (Figures g and h). Turn the forceps around (Figure h).

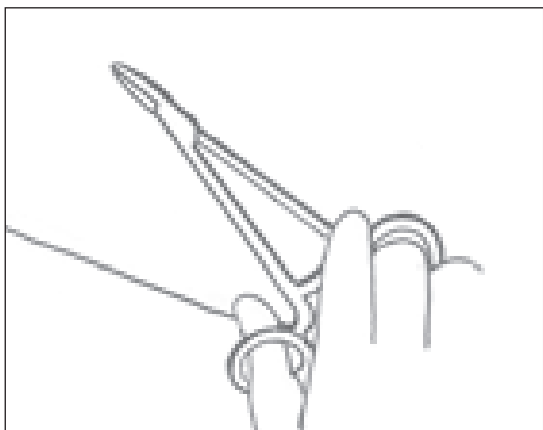


Figure g

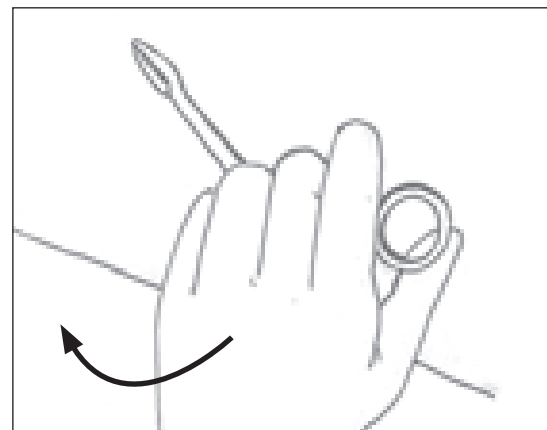


Figure h

9. With a second forceps carefully dissect the tissue around the implant(s) and then remove it (Figure i). Be sure to remove the rod entirely. Confirm that the entire rod, which is 4 cm long, has been removed by measuring its length.

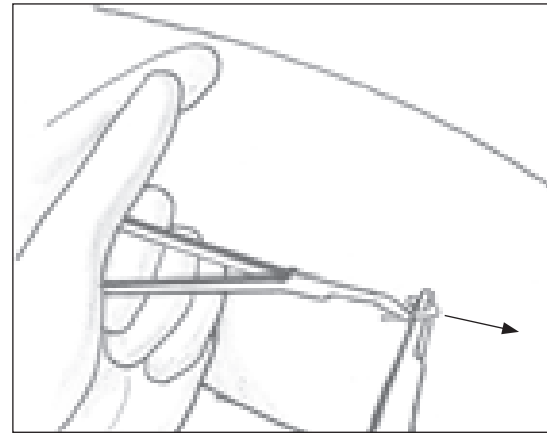


Figure i

If the client would like to continue using implant(s) insert new rod/s immediately after the old one/s is/are removed. The new implant(s) can be inserted in the same arm, and through the same incision, or a new implant(s) can be inserted in the other arm.

If the client does not wish to continue using implant(s) and does not want to become pregnant, counsel for another contraceptive method.

10. After removing the implant(s) close the incision with a butterfly closure and apply an adhesive bandage.
11. Apply a pressure bandage with sterile gauze to minimize bruising.

**Note:**

There is usually more bleeding during removal than during insertion.

Occasionally the rods cannot be removed readily at the first visit (see also the next subsection for suggestions on how to remove hard-to-reach rods). Do not take heroic measures to remove the difficult ones. Send the woman home and ask her to return in four to six weeks, after the area is fully healed. The remaining implant(s) will be readily located and removed at a second visit. If the woman does not want to run the risk of pregnancy, she should be given a backup method to use such as condoms.

## Removing the Hard To Retrieve Implants

There have been occasional reports of migration of the implant; usually this involves minor movement relative to the original position. This may complicate localization of the implant by palpation, ultrasound or magnetic resonance imaging, and removal may require a larger incision and more time.

Exploratory surgery without knowledge of the exact location of the implant is strongly discouraged. Removal of deeply inserted implants should be conducted with caution in order to prevent damage to deeper neural or vascular structures in the arm and be performed by healthcare providers familiar with the anatomy of the arm.

The client's position for removal is similar to the position for insertion. Use aseptic technique

1. Feel the ends of the implant with the left fore- and middle fingers (Reverse hands if you are left-handed). Keeping the middle finger on the distal end of the rod, and the forefinger on the end nearest to you, push the implant toward the incision.
2. Introduce the curved mosquito forceps into the incision below the implant. At the same time, keep pressing the end of the implant with your forefinger.

3. Grasp the implant from below with the mosquito forceps pointing toward the surface on the skin, pushing against the forefinger. Approximately 1 cm of the forceps will now be inside the incision and under the skin.
4. Do not try to pull the implant out. Instead, while continuing to push the end of the rod toward the incision rotate the handle of the forceps 180 degrees and grasp with the left hand until the forceps points in the opposite direction.
5. Clean the soft tissue surrounding the rod with gauze until the implant becomes visible.
6. Open the tissue envelope, grasp the rod with the second forceps, and remove.

If the implant does not become visible with the maneuvers in steps 3 and 4, then twist the forceps 180 degrees around its main axis. The tip of the implant will then open the fibrous tissue rod. With the right hand, use the second forceps to grasp the part of the rod that becomes visible and remove it.

If required, additional small amounts of local anaesthetic can be used for the removal of the implants.

### **Rods that cannot be palpated:**

There are two ways to locate implant rods that have been inserted too deeply to feel with the fingers: ultrasound and MRI. Their depth cannot be assured, however, and further examination would be required to establish their exact location. The acoustic shadow cast by the implants also can be easily and reliably detected by an ultrasound scanner.

### **Client instructions after implants removal**

- Observe the woman for few minutes before sending her home. Tell her that when the anaesthetic wears off, there will be some tenderness for a day or two. As after the insertion, there may be some discoloration, bruising, and swelling for a few days in the areas where the implants were removed.
- Remind her to keep the area around the incision clean and dry for four days, to keep the protective bandage in place for three days, and the small adhesive bandage for a day or two longer to prevent infection
- Since the protective effect diminishes rapidly after the implants are removed, make sure the woman is provided with an alternative contraceptive method if she does not want to become pregnant.
- After the site has healed, she does not have to worry about bumping the area or putting pressure on it. The area can be touched and washed. The implants will remain where they are placed.

### **Second Insertion (for women who want to continue using Implants)**

- If the woman wants to continue using implants, the second set should be inserted at the time the first set is removed
- The implant(s) may be placed through the incision from which the earlier set was removed. If two rods, they can be inserted in a V shape in the opposite direction. When inserted in the opposite direction, be sure the rods do not lie so close to the elbow crease as to interfere with its movement
- A new incision should be necessary only if there is not enough room between the incision and the elbow crease or if the area of the original insertion is bruised
- The implants may be placed in the other arm if the site of the first insertion is unsuitable.

## Follow-up and Reasons to Return

Assure every client that she is welcome to come back any time—for example, if she has problems, questions, or wants another method; she has a major change in health status, or she thinks she might be pregnant. Also if:

- She has pain, heat, pus, or redness at the insertion site that becomes worse or does not go away, or she sees a rod coming out
- She has gained a lot of weight. This may decrease the length of time her implants remain highly effective.

General health advice: Anyone who suddenly feels that something is seriously wrong with her health should immediately seek medical care from a nurse or doctor. Her contraceptive method is most likely not the cause of the condition, but she should tell the nurse or doctor what method she is using.

## Discuss how to remember the date to return for removal.

Unless there is a problem, the woman does not need to be concerned about the implants until she has them removed. Many clinics recommend follow-up visits at yearly intervals as part of preventive healthcare.

The client's record indicates the follow-up date and clients have cards with the date of return. This is useful to keep track of the client and the method she is using. It is also used as a programmatic check-up for the number of clients of a certain method in the program. This facilitates contacting the woman and aids in maintaining accurate service statistics.

Some prototype user booklets end with a passage of time depiction and the back cover contains the written message: By (month/year), have your implants removed. These dates are to be filled in by clinic personnel at the time of implant insertion. Women could be instructed to return on their birth date closest to the timing of the insertion. Jadelle should be removed after five years, Implanon after three years and Sino-Implant should be removed after four years.

## Supporting the user

### Post insertion instructions (care of the arm, associated problems post insertion)

- Before the client is discharged, observe her for 15-30 minutes for bleeding from the incision or any other adverse effects
- Give her post insertion care instructions
- Give her analgesics or any other prescribed drug as may apply
- Immediately place a notation in the client's file indicating the location of the implant rods and specifying any unusual events that may have occurred during insertion
- Tell the woman to expect some tenderness for a day or two at the insertion site when the anaesthetic wears off. There may be some discoloration, bruising, and swelling in the area of the implant insertion for the first few days. This is common and will go away without treatment
- The woman should try not to bump the insertion site for a few days. She should keep the area dry and clean for 4 days and leave the protective bandage in place for two days, and the small adhesive bandage five days to prevent infection
- She can resume her normal activities immediately: household chores, childcare, employment.

**IMPORTANT:** No routine return visit is required until it is time to remove the implants. The client should be invited to return any time she wishes. If she does return for any reason:

- Ask how the client is doing with the method and whether she is satisfied
- Ask if she has any questions or anything to discuss
- Ask especially if she is concerned about bleeding changes. Give her any information or help that she needs
- Ask a long-term client if she has had any new health problems since her last visit. Address problems as appropriate
- Ask a long-term client about major life changes that may affect her needs particularly plans for having children and STI/HIV risk. Follow up as needed
- If possible, weigh the client who is using two rod implants. If her weight has changed enough to affect the duration of her implants' effectiveness, update her reminder card, if she has one, or give her a new reminder card with the proper date
- If she wants to keep using implants and no new medical condition prevents it, remind her how much longer her implants will protect her from pregnancy.

## Managing Any Problems

### Problems Reported as Side Effects or Complications

May or may not be due to the method of contraception.

- Problems with side effects and complications affect women's satisfaction and use of implants. They deserve the provider's attention. If the client reports any side effects or complications, listen to her concerns, give her advice, and, if appropriate, treat.
- Offer to help the client choose another method—now, if she wishes, or if problems cannot be overcome.

### Irregular Bleeding (bleeding at unexpected times that bother the client)

- Reassure her that many women using implants experience irregular bleeding. It is not harmful and usually becomes less or stops after the first year of use.
- For modest short-term relief, she can take 800 mg ibuprofen or 500 mg mefenamic acid 3 times daily after meals for 5 days, beginning when irregular bleeding starts.
- If these drugs do not help her, she can try one of the following, beginning when irregular bleeding starts:
  - Combined oral contraceptives with the progestin levonorgestrel. Ask her to take one pill daily for 21 days
  - 50 µg ethinyl oestradiol daily for 21 days
- If irregular bleeding continues or starts after several months of normal or no monthly bleeding, or you suspect that something may be wrong for other reasons, consider underlying conditions unrelated to method use.

### No monthly bleeding

- Reassure her that some women stop having monthly bleeding when using implants and this is not harmful. There is no need to lose blood every month. It is similar to not having monthly bleeding during pregnancy. She is not infertile. Blood is not building up inside her. (Some women are happy to be free from monthly bleeding though.)

Heavy or prolonged bleeding (twice as much as usual, or longer than 8 days)

- Reassure her that some women using implants experience heavy or prolonged bleeding. It is generally not harmful and usually becomes less or stops after a few months.
- For modest short-term relief, she can try one of the treatments for irregular bleeding, above, beginning when heavy bleeding starts. Combined oral contraceptives with 50 µg of ethinyl oestradiol may work better than lower-dose pills.
- To help prevent anaemia, suggest she take iron tablets and tell her it is important to eat foods containing iron, such as meat and poultry (especially beef and chicken liver), fish, green leafy vegetables, and legumes (beans, bean curd, lentils, and peas).
- If heavy or prolonged bleeding continues or starts after several months of normal or no monthly bleeding, or you suspect that something may be wrong for other reasons, consider underlying conditions unrelated to method use.

Ordinary headaches (non-migrainous)

- Suggest aspirin (325–650 mg), ibuprofen (200–400 mg), paracetamol (325–1000 mg), or other pain reliever.
- Any headaches that get worse or occur more often during use of implants should be evaluated.

Mild abdominal pain

- Suggest aspirin (325–650 mg), ibuprofen (200–400 mg), paracetamol (325–1000 mg), or other pain reliever.

Acne

- If client wants to stop using implants because of acne, she can consider switching to COCs. Many women's acne improves with COC use.

Weight change

- Review diet and counsel as needed.

Breast tenderness

- Recommend that she wears a supportive bra (including during strenuous activity and sleep).
- Try hot or cold compresses.
- Suggest aspirin (325–650 mg), ibuprofen (200–400 mg), paracetamol (325–1000 mg), or other pain reliever.

Mood changes or changes in sex drive

- Ask about changes in her life that could affect her mood or sex drive, including changes in her relationship with her partner. Give her support as appropriate.
- Clients who have serious mood changes such as major depression should be referred for care.

Pain after insertion or removal

- For pain after insertion, check that the bandage or gauze on her arm is not too tight.
- Put a new bandage on the arm and advise her to avoid pressing on the site for a few days.
- Give her aspirin (325–650 mg), ibuprofen (200–400 mg), or paracetamol (325–1000 mg)



Infection at the Insertion site (redness, heat, pain, pus)

- Do not remove the implants.
- Clean the infected area with soap and water or antiseptic.
- Give oral antibiotics for 7 to 10 days.
- Ask the client to return after taking all antibiotics if the infection does not clear. If infection has not cleared, remove the implants or refer for removal.
- Expulsion or partial expulsion often follows infection. Ask the client to return if she notices an implant coming out.

Abscess (pockets of pus under the skin due to infection)

- Clean the area with antiseptic.
- Cut open (incise) and drain the abscess.
- Treat the wound.
- Give oral antibiotics for 7 to 10 days.
- Ask the client to return after taking all antibiotics if she has heat, redness, pain, or drainage of the wound. If infection is present when she returns, remove the implants or refer for removal.

Expulsion (when one or two rods begin to come out of the arm).

- Rare. Usually occurs within a few months of insertion or with infection.
- If no infection is present, replace the expelled rod through a new incision near the other rods, or refer for replacement.

Severe pain in lower abdomen (suspected ectopic pregnancy or enlarged ovarian follicles or cyst)

- Many conditions can cause severe abdominal pain. Be particularly alert for additional signs or symptoms of ectopic pregnancy, which is rare but can be life-threatening.
  - In the early stages of ectopic pregnancy, symptoms may be absent or mild, but eventually they will become severe. A combination of these signs or symptoms should increase suspicion of ectopic pregnancy:
  - Unusual abdominal pain or tenderness
- Abnormal vaginal bleeding or no monthly bleeding - especially if this is a change from her usual bleeding pattern
  - Light-headedness or dizziness
  - Fainting
  - If ectopic pregnancy or other serious health condition is suspected, refer at once for immediate diagnosis and care.
  - Abdominal pain may be due to other problems, such as enlarged ovarian follicles or cysts.
- A woman can continue to use implants during evaluation
- There is no need to treat enlarged ovarian follicles or cysts unless they grow abnormally large, twist, or burst. Reassure the client that they usually disappear on their own. To be sure the problem is resolving, see the client again in 6 weeks, if possible.

## **New Problems That May Require Switching Methods**

They may or may not be due to the method

Unexplained vaginal bleeding (that suggests a medical condition not related to the method)

- Refer or evaluate by history and pelvic examination. Diagnose and treat as appropriate.
- If no cause of bleeding can be found, consider stopping implants to make diagnosis easier. Provide another method of her choice to use until the condition is evaluated and treated (not progestin-only injectables, or a copper-bearing or hormonal IUCD).
- If bleeding is caused by sexually transmitted infection or pelvic inflammatory disease, she can continue using implants during treatment.

Migraine headaches

- If she has developed headaches without aura, she can continue to use implants if she wishes.
- If she has migraine with an aura, remove the implants. Help her choose a method without hormones.

Certain serious conditions (suspect blood clots in deep veins of the legs or lungs, liver disease or breast cancer)

- Remove the implants or refer for removal.
- Give her a backup method to use until her condition is evaluated.
- Refer for diagnosis and care if not already under care.

Heart disease due to blockage or narrowed arteries (ischaemic heart disease) or stroke

- A woman who has one of these conditions can safely start implants. If, however, the condition develops while she is using implants:
  - Remove the implants or refer for removal.
  - Help her choose a method without hormones.
  - Refer for diagnosis and care if not already under care.

Suspected Pregnancy

- Assess for pregnancy, including ectopic pregnancy.
- Remove the implants or refer for removal if she will carry the pregnancy to term. There are no known risks to a foetus conceived while a woman has implants in place.

## **Who Is Allowed To Insert and Remove Implants**

- Trained clinicians and Nurses

## **CHAPTER 12:**

# **INTRA UTERINE CONTRACEPTIVE DEVICE (IUCD)**

### **Overview**

#### **What Is the IUCD?**

An IUCD is a small, flexible plastic T-shaped frame with that is inserted into a woman's uterus to prevent pregnancy. In Tanzania the most common IUCD is a copper bearing device with copper bands or wire around the stem and arms.

This chapter will focus on:

- Definition of IUCD
- Effectiveness
- Characteristics
- Medical eligibility criteria
- Provision and Removal of IUCD
- Managing any problems using the SOAP approach

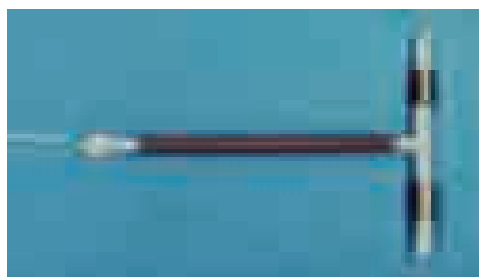
## IUCD types:

- The copper-bearing IUCDs - T380A (TCu-380A) and Multiload. The TCu-380A provides protection from pregnancy for at least 12 years and Multiload for 5 years
- The hormonal IUCD steadily releases small amounts of levonorgestrel into the uterine cavity. It is also called levonorgestrel-releasing intrauterine system (LNG-IUS). It is marketed under the brand name Mirena and it provides protection from pregnancy for 5 years
- Almost all types of IUCDs have one or two strings, or threads, tied to them. The strings hang through the cervix into the vagina
- A specifically trained health care provider inserts the IUCD into a woman's uterus through her vagina and cervix.

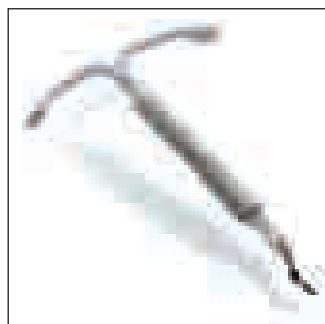
## Mechanism of Action of IUCDs

Copper IUCDs work primarily by causing a chemical change in the uterus that damages sperm and ovum before they can meet, in other words, IUCDs prevent fertilization.

IUCDs that contain progesterone also cause thickening of cervical mucus, which stops the sperm from entering the uterus.



T380A (TCu-380A)



Multiload

From this point onwards, most of the information provided is particular to the Copper IUD. This is the IUCD most commonly used in Tanzania. The LNG IUS is expensive and not readily available in Tanzania.

## Effectiveness of Copper IUCDs

Copper T 380A IUCD is the most effective and longest-acting reversible method of contraception: it has a protective effect of at least 12 years, and is more than 99% effective.

The pregnancy rate is less than 1 pregnancy per 100 women using an IUCD over the first year (6 to 8 per 1,000 women). This means that 992 to 994 of every 1,000 women using IUCDs will not become pregnant. A small risk of pregnancy remains beyond the first year of use and continues as long as the woman is using the IUCD.

## Characteristics of Copper IUCDs

Advantages:

- Highly effective and safe
- Long-acting
- Easy to use: does not require the user to do anything once the IUCD is inserted

- Does not interfere with sex
- Allows the client privacy and control over her fertility
- No delay in return to fertility after IUCD is removed
- Has no further costs after the IUCD is inserted. One visit for insertion, and minimal follow-up required after first 6-week check-up (unless client has problems)
- Does not interact with medications
- Can be removed at any time
- Complications are very rare
- Evidence suggests the copper IUCD can protect users from endometrial cancer
- Can be cost-effective over time due to its initial cost and effectiveness.

Disadvantages:

- Initial cost may be higher than short-acting methods
- A trained provider is required to insert and remove an IUCD
- Has common side effects, especially in the first 3 months after insertion:
  - Prolonged and heavy monthly bleeding
  - Irregular bleeding
  - More cramps and pain during monthly bleeding
- Complications, while rare, may occur
  - Uterine perforation during insertion (relates to skill of provider; usually heals without treatment)
  - Miscarriage, preterm birth, or infection in the rare cases that the woman becomes pregnant with the IUCD in place
- Health risks
  - May contribute to anaemia in women who are already anaemic and in whom IUCD causes heavy monthly bleedings (uncommon)
  - Pelvic inflammatory disease (PID) may occur if woman has Chlamydia or Gonorrhoea at the time of IUCD insertion
- Provides no protection from STIs, including HIV
- Some complications may require immediate attention and thus clients should have access to clinical back-up services.

**Note:**

IUCDs do not increase the risk of ectopic pregnancy. Studies have found that IUCD users are 5 times less likely to experience an ectopic pregnancy than women using no contraception. However, in the unlikely event of pregnancy occurring in an IUCD user, that pregnancy is more likely to be ectopic than would be a pregnancy in a non-user. Still, pregnancy for an IUCD user is far more likely to be normal than ectopic: only an estimated 6 to 8 in every 100 pregnancies, or 6% to 8%, are ectopic.

## Correcting Misconceptions about IUCDs

Intrauterine devices:

- Rarely lead to PID.
- Do not increase the risk of contracting STIs, including HIV.
- Do not increase the risk of miscarriage when a woman becomes pregnant after the IUCD is removed.
- Do not make women infertile.
- Do not cause birth defects.
- Do not cause cancer.
- Do not move to the heart or brain.
- Do not cause discomfort or pain for the woman during sex.
- Substantially reduce the risk of ectopic pregnancy.

## Who Can Use Copper IUCD

Copper-Bearing IUCD is safe and suitable for nearly all women

Most women can use IUCDs safely and effectively, including women who:

- Have or have not had children
- Are not married
- Are of any age, including adolescents and women over 40 years old
- Have just had an abortion or miscarriage (if no evidence of infection)
- Are breastfeeding
- Do hard physical work
- Have had ectopic pregnancy
- Have had pelvic inflammatory disease (PID)
- Have vaginal infections
- Have anaemia
- Are infected with HIV; or women who have AIDS but are on antiretroviral therapy and doing well

Women can begin using IUCDs:

- Without STI testing
- Without an HIV test
- Without any blood tests or other routine laboratory test
- Without cervical cancer screening
- Without a breast examination

## Screening for Medical Eligibility for Copper IUCD

Ask the client the questions below about known medical conditions. If she answers NO to all of the questions, then she can have an IUCD inserted if she wants. If she answers YES to a question, follow the instructions. In some cases she can still have an IUCD inserted. These questions also apply to the levonorgestrel IUCD.

**1. Did you give birth more than 48 hours ago but less than 4 weeks ago?**

No  Yes

If YES, delay inserting an IUCD until 4 or more weeks after childbirth

**2. Do you have an infection following childbirth or abortion?**

No  Yes

If she currently has infection of the reproductive organs during the first 6 weeks after childbirth (puerperal sepsis) or she just had an abortion-related infection in the uterus (septic abortion), do not insert the IUCD. Treat or refer if she is not already receiving care. Help her choose another method or offer a backup method. After treatment, re-evaluate for IUCD use

**3. Do you have vaginal bleeding that is unusual for you?**

No  Yes

If she has unexplained vaginal bleeding that suggests pregnancy or an underlying medical condition, use of an IUCD could make diagnosis and monitoring of any treatment more difficult. Help her choose a method to use while being evaluated and treated (but not a hormonal IUCD, progestin only injectables, or implants). After treatment, re-evaluate for IUCD use.

**4. Do you have any female conditions or problems (gynaecologic or obstetric conditions or problems), such as genital cancer or pelvic tuberculosis? If so, what problems?**

No  Yes

Known current cervical, endometrial, or ovarian cancer; gestational trophoblast disease; pelvic tuberculosis: do not insert an IUCD. Treat or refer for care if she is not already receiving care. Help her choose another method. In case of pelvic tuberculosis, re-evaluate for IUCD use after treatment.

**5. Do you have AIDS?**

No  Yes

Do not insert an IUCD if she has AIDS unless she is clinically well or on antiretroviral therapy. If she is infected with HIV but does not have AIDS, she can use an IUCD. If a woman who has an IUCD in place develops AIDS, she can keep the IUCD if she chooses.

**6. Assess whether she is at very high individual risk for Gonorrhoea or Chlamydia.**

Women who have a very high individual likelihood of exposure to Gonorrhoea or Chlamydia should not have an IUCD inserted (see Assessing Women for Risk of Sexually Transmitted Infections,)

**7. Assess whether the client might be pregnant.**

Ask the client the questions in the pregnancy checklist (see chapter 6). If she answers YES to any question, she can have an IUCD inserted.

## Screening Questions for Pelvic Examination

When performing the pelvic examination prior to IUCD insertion, asking yourself the questions below helps you check for signs of conditions that would rule out IUCD insertion. If the answer to all of the questions is NO, then the client can have an IUCD inserted. If the answer to any question is YES, do not insert an IUCD.

For questions 1 through 5, if the answer is YES, refer for diagnosis and treatment as appropriate. Help her choose another method and counsel her about condom use if she faces any risk of sexually transmitted infections (STIs). Give her condoms, if possible. If STI or pelvic inflammatory disease (PID) is confirmed and she still wants an IUCD, it may be inserted as soon as she finishes treatment, if she is not at risk for re-infection by the time of insertion.

**1. Is there any type of ulcer on the vulva, vagina, or cervix?**

No  Yes

If YES, possible STI

**2. Does the client feel pain in her lower abdomen when you move the cervix?**

No  Yes

If YES, possible PID

**3. Is there tenderness in the uterus, ovaries, or fallopian tubes (adnexal tenderness)?**

No  Yes

If YES, possible PID

**4. Is there a purulent cervical discharge?**

No  Yes

If YES, possible STI or PID

**5. Does the cervix bleed easily when touched?**

No  Yes

If YES, possible STI or cervical cancer

**6. Is there an anatomical abnormality of the uterine cavity that will prevent correct IUCD insertion?**

No  Yes

If an anatomical abnormality distorts the uterine cavity, proper IUCD placement may not be possible. Help her choose another method.

**7. Were you unable to determine the size and/or position of the uterus?**

No  Yes

Determining the size and position of the uterus before IUCD insertion is essential to ensure high placement of the IUCD and to minimize risk of perforation. If size and position cannot be determined, do not insert an IUCD. Help her choose another method.



## **Intrauterine Devices for Women with HIV**

- Women who are at risk of HIV or are infected with HIV can safely have the IUCD inserted.
- Women who have AIDS, are on antiretroviral therapy (ART), and are clinically well can safely have the IUCD inserted.
- Women who have AIDS but who are not on (ART), or who are not clinically well should not have the IUCD inserted.
- If a woman develops AIDS while she has an IUCD in place, it does not need to be removed if she wishes to continue using it.
- IUCD users with AIDS should be monitored for pelvic inflammatory disease.
- Urge women to use condoms along with the IUCD. Used consistently and correctly, condoms help prevent transmission of HIV and other STIs.

## **Assessing Women for Risk of STIs prior to IUCD insertion**

A woman who currently has Gonorrhoea or Chlamydia should not have an IUD inserted. Having these sexually transmitted infections (STIs) at insertion may increase the risk of pelvic inflammatory disease. These STIs may be difficult to diagnose clinically, however, and reliable laboratory tests are time-consuming, expensive, and often unavailable. Without clinical signs or symptoms and without laboratory testing, the only indication that a woman might already have an STI is whether her behaviour or her situation places her at very high individual risk of infection. If this risk for the individual client is very high, she generally should not have an IUD inserted. (Local STI prevalence rates are not a basis for judging individual risk.)

There is no universal set of questions that will determine if a woman is at very high individual risk for Gonorrhoea and Chlamydia. Instead of asking questions, providers can discuss with the client the personal behaviours and the situations in their community that are most likely to expose women to STIs.

Steps to take:

- Tell the client that a woman who faces a very high individual risk of some STIs usually should not have an IUCD inserted unless laboratory tests are available to rule out presence of Gonorrhoea or Chlamydia.
- Ask the woman to consider her own risk and to think about whether she might have an STI. A woman is often the best judge of her own risk. She does not have to tell the provider about her behaviour or her partner's behaviour. Providers can explain possibly risky situations that may place a woman at very high individual risk. The client can think about whether such situations occurred recently (in the past 3 months or so). If so, she may have an STI now and may want to choose a method other than the IUD. If the woman thinks she is at high individual risk of STI the provider should send her for diagnosis and then treat.
- Possibly risky situations include:
  - A sexual partner has STI symptoms such as discharge coming from his penis, pain or burning during urination, or an open sore in the genital area
  - She or a sexual partner was diagnosed with an STI recently
  - She has had more than one sexual partner recently
  - She has a sexual partner who has had other partners recently

- Ask if she thinks she is a good candidate for an IUCD or would like to consider other contraceptive methods. If, after considering her individual risk, she thinks she is a good candidate, and she is eligible, provide her with an IUCD. If she wants to consider other methods or if you have strong reason to believe that the client is at very high individual risk of infection, help her choose another method.

**Note:**

If she still wants the IUCD while at very high individual risk of Gonorrhoea and Chlamydia, and reliable STI testing is available, a woman who tests negative can have an IUCD inserted. A woman who tests positive can have an IUD inserted as soon as she finishes treatment, if she is not at risk of re-infection by the time of insertion. When a woman chooses IUCD she should always be counselled about warning signs of infection.

Also if a current IUCD user's situation changes and she finds herself at very high individual risk for Gonorrhoea or Chlamydia, she can keep using her IUCD if she chooses.

## Providing Copper IUCD

### When to Insert

**IMPORTANT:** In many cases a woman can start the IUCD any time it is reasonably certain she is not pregnant. To be reasonably certain she is not pregnant, use the Pregnancy Checklist (see chapter 6).

Woman's situation	When to start
Having menstrual cycles	Any time of the month  If she is starting within 12 days after the start of her monthly bleeding, no need for a backup method.  If it is more than 12 days after the start of her monthly bleeding, she can have the IUCD inserted any time it is reasonably certain she is not pregnant. No need for a backup method.
Switching from another method	Immediately, if she has been using the method consistently and correctly or if it is otherwise reasonably certain she is not pregnant. No need to wait for her next monthly bleeding. No need for a backup method.  If she is switching from injectables, she can have the IUCD inserted when the next injection would have been given. No need for a backup method.
Soon after childbirth	Any time within 48 hours after giving birth (requires a provider with specific training in postpartum insertion).  If it is more than 48 hours after giving birth, delay IUCD insertion until 4 weeks or more after giving birth.
Fully or nearly fully breastfeeding, less than 6 months after giving birth	If her monthly bleeding has not returned, she can have the IUCD inserted any time between 4 weeks and 6 months after giving birth. No need for a backup method.  If her monthly bleeding has returned, she can have the IUCD inserted as advised for women having menstrual cycles (see above).

Fully or nearly fully breastfeeding, more than 6 months after giving birth	<p>If her monthly bleeding has not returned, she can have the IUCD inserted any time it is reasonably certain she is not pregnant. No need for a backup method.</p> <p>If her monthly bleeding has returned, she can have the IUCD inserted as advised for women having menstrual cycles (see previous page).</p>
Partially breastfeeding or not breastfeeding, more than 4 weeks after giving birth	<p>If her monthly bleeding has not returned, she can have the IUCD inserted if it can be determined that she is not pregnant. No need for a backup method.</p> <p>If her monthly bleeding has returned, she can have the IUCD inserted as advised for women having menstrual cycles (see above)</p>
No monthly bleeding (not related to childbirth or breastfeeding)	Any time if it can be determined that she is not pregnant. No need for a backup method.
After miscarriage or abortion	<p>Immediately, if the IUCD is inserted within 12 days after first- or second-trimester abortion or miscarriage and if no infection is present. No need for a backup method.</p> <p>If it is more than 12 days after first- or second trimester miscarriage or abortion and no infection is present, she can have the IUCD inserted any time it is reasonably certain she is not pregnant. No need for a backup method</p> <p>If infection is present, treat or refer and help the client choose another method. If she still wants the IUCD, it can be inserted after the infection has completely cleared.</p> <p>IUCD insertion after second-trimester abortion or miscarriage requires specific training. If not specifically trained, delay insertion until at least 4 weeks after miscarriage or abortion.</p>
If used as emergency contraception	<p>Within 5 days after unprotected sex.</p> <p>When the time of ovulation can be estimated, she can have an IUCD inserted up to 5 days after ovulation. In some cases this may add up to more than 5 days after unprotected sex.</p>
After taking emergency contraceptive pills	The IUCD can be inserted on the same day that she takes the ECPs. No need for a backup method.

## Counselling About Side Effect

**IMPORTANT:** Thorough counselling about bleeding changes must come before IUCD insertion. Counselling about bleeding changes may be the most important help a woman needs to keep using the method.

Describe the most common side effects:

- Prolonged and heavy monthly bleeding
- Irregular bleeding
- More cramps and pain during monthly bleeding

Explain about these side effects:

- Bleeding changes are not signs of illness.
- Usually reduce/disappear after the first several months after insertion.
- Client can come back to the clinic for help if side effects bother her.

#### Explaining the Insertion Procedure

A woman who has chosen the IUCD needs to know what to expect and what is happening during insertion. The following description can help explain the procedure to her.

- Show her the IUCD and inserter in the package
- Tell her that she will experience some discomfort or cramping during the procedure, and that this is to be expected
- Talk with the client throughout the procedure
- Tell her what is happening step-by-step
- Provide reassurance
- Alert her before any step that might cause pain
- Ask her to tell you any time that she feels discomfort or pain
- Ask from time to time if she is feeling pain

### **Clinical Procedure for Insertion of IUCD**

Proper insertion technique can help prevent many problems, such as infection, expulsion, and perforation. The “no-touch” insertion technique is the best way to ensure safety.

This includes loading an IUCD inside the sterile package, not letting the loaded IUCD or uterine sound touch any unsterile surfaces, and passing instruments and IUCD inserter through cervix only once. Follow proper infection-prevention procedures as described in chapter 3.

#### Prepare Self, Client and Materials

- Prepare the room and assemble materials and equipment following infection prevention procedures
- Ask client to empty bladder
- Check the IUCD package for expiration and manufacture date and damage to the package
- Ensure privacy
- Ask the client to undress from the waist down
- Assist client to get on to the examination couch and lie in lithotomy position
- Cover the client
- Wash and dry hands
- Put on sterile gloves aseptically
- Ask client to pull the cover up to the waist

## Inserting CuT-380A IUCD

### STEP 1:

Prepare the client: Give the woman a brief overview of the procedure, encourage her to ask questions, and provide reassurance as needed. Remind her to let you know if she feels any pain.

### STEP 2:

Inspect the vulva and groin

Check for ulcers, swellings and discharge.

### STEP 3:

Perform bimanual examination (before speculum examination to avoid use of two speculums on one client. Use of two speculums subjects the client to discomfort twice.) (see chapter 6)

Swab the vulva if the client is menstruating

Insert two gloved fingers into the vagina

Perform bimanual examination

- Check for tenderness in the uterus, ovaries or fallopian tubes
- Determine position of the uterus

### STEP 4:

Perform speculum examination (see chapter 6)

Insert the speculum gently into the vagina, in a horizontal position, and advance

Observe colour of cervix, check for sores, warts and discharge. See if cervix bleeds easily when touched.

Do not remove the speculum

### STEP 5:

Gently grasp cervical lip with a tenaculum at imaginary 10 o'clock or 2 o'clock site of the upper cervical lip and apply gentle traction (close the tenaculum only to the first notch to minimize discomfort). Alternatively, a Vulsellum forceps can be used.

### STEP 6:

Sound the uterus

Hold the uterine sound between the thumb and forefinger. Determine which way to position the uterine sound based on the assessment of the position of the uterus; the curved tip of the sound should face downwards in case of the retroverted uterus and upwards in case of anteverted uterus. Pull steadily on the tenaculum downwards and outwards in order for the uterine cavity to align with the vaginal canal. Insert uterine sound into the cervical canal gently, while maintaining a gentle traction on the tenaculum. Gently allow the uterine sound to guide itself into the direction of the uterine cavity until it reaches the fundus and cannot go any further. Insert the sound once only to reduce chances of introducing infection.

Withdraw the uterine sound and note depth of the uterine cavity by looking at the level of mucus or blood on the sound. Normal depth is 6.5-8 cm.

- If there is resistance and the uterine sound has not moved much, stop and refer the client for further management.
- If the uterus sounds to a depth of 10 cm or more, the sound may have perforated the uterus. Do not insert the IUCD into the uterus. - Ask client to rest and observe client for signs of shock (pulse, BP, thirst, pallor, fainting) and refer to a doctor if pulse is rapid or BP falls.

**STEP 7:**

Load an IUCD without taking it out of the sterile package

Now IUCD is ready for insertion. It is important not to load an IUCD too early as it may not unfold properly when IUCD arms are released from the inserter in the uterine cavity

Position the blue depth gauge equal to the depth of uterus as seen from the uterine sound.

**STEP 8:**

Put new/clean examination or high-level disinfected gloves on both hands.

**STEP 9:**

Carefully insert the loaded IUCD: Carefully insert the loaded IUCD into the vaginal canal (Figure 1), and gently advance it through the cervical os and into the uterine cavity at the appropriate angle (based on your assessment of the position of the uterus during the bimanual exam and when sounding the uterus). Be careful not to touch the walls of the vagina or the speculum blades with the tip of the loaded IUD.

**STEP 10:**

Gently advance the loaded IUCD into the uterine cavity and STOP when the blue depth-gauge comes in contact with the cervix or slight resistance is felt (figure 7). Be sure that the blue depth gauge is still in the horizontal position. Do not use force at any stage of this procedure.

**STEP 11:**

Hold the tenaculum and white plunger rod stationary, while partially withdrawing the insertion tube: While holding the tenaculum and plunger rod stationary (in one hand), gently pull the insertion tube toward yourself (with your free hand) until it touches the circular thumb grip of the white plunger rod (This will release the IUCD in the woman's uterus.)

**STEP 12:**

Remove the white plunger rod, while holding the insertion tube stationary.

**STEP 13:**

Gently push insertion tube upward until you feel a slight resistance: Once the plunger rod has been removed, very gently and carefully push the insertion tube upward again, toward the fundus of the uterus, until you feel a slight resistance (Figure 7). (This step ensures that the arms of the T are as high as possible in the uterus, as shown in Figure 8)

**STEP 14:**

Use high-level disinfected (or sterile) sharp but not pointed Mayo scissors to cut the IUCD strings at 3 to 4 cm:

Partially withdraw the insertion tube from the cervical canal until the strings can be seen extending from the cervical os, but still caught within the tube, and use sharp non pointed

Mayo scissors to cut the strings at 3 to 4 cm from the cervical opening. (This technique ensures that the pieces of cut-off string will stay in the insertion tube for easy disposal.)

Place the insertion tube and scissors in 0.5% chlorine solution for 10 minutes for decontamination.

**STEP 15:**

Gently remove the tenaculum and place it in 0.5% chlorine solution for 10 minutes for decontamination.

**STEP 16:**

Examine the woman's cervix for bleeding: If there is bleeding where the tenaculum was attached to the cervix, use high-level disinfected (or sterile) forceps to place a cotton (or gauze) swab on the affected tissue, and apply gentle pressure for 30 to 60 seconds.

**STEP 17:**

Gently remove the speculum and place it in 0.5% chlorine solution for 10 minutes for decontamination.

**STEP 18:**

Allow the woman to rest. Advise the woman to remain on the examination table until she feels ready to get dressed. Begin performing the post-insertion steps while she is resting. Figure 1: Vertical stem of the T, fully inside the Inserter

Figure 1: Vertical stem of the T, fully inside the Inserter

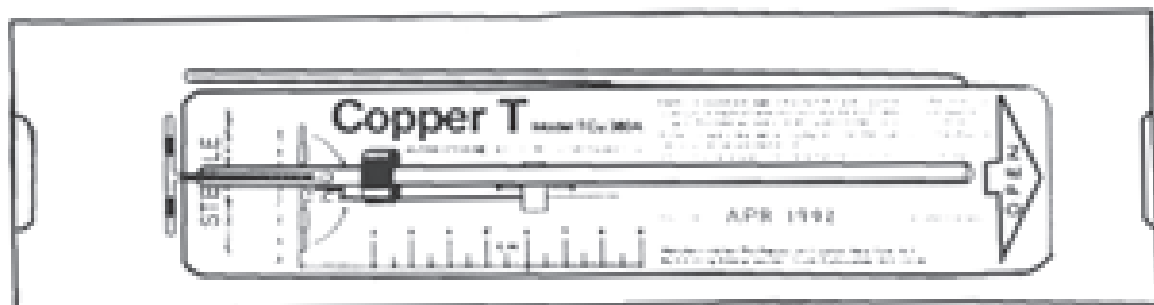


Figure 2: Peel back packing flaps away from each other.



Figure 3: Loading IUCD

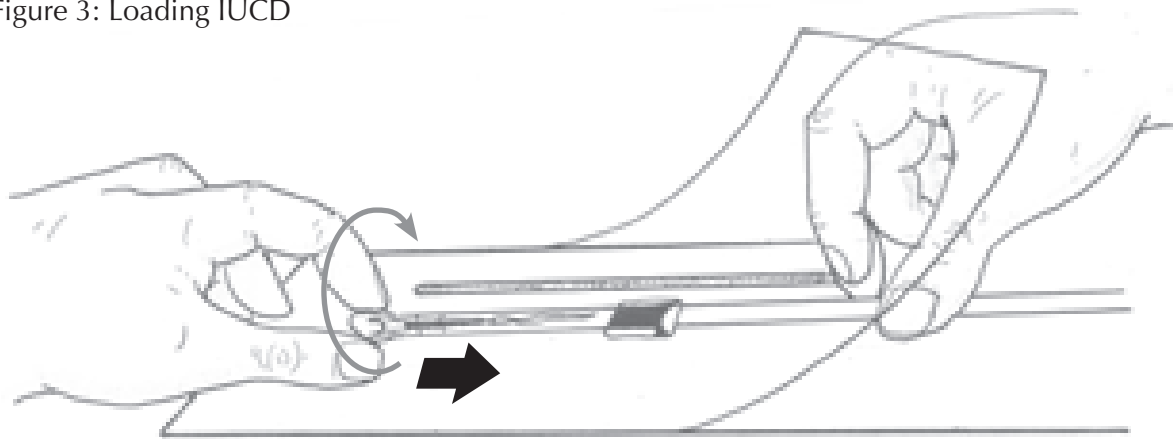


Figure 4: Copper T arms inserted while rotating and pushing the tube.

Figure 5: Measuring the length of the inserter load to the depth of the Uterus

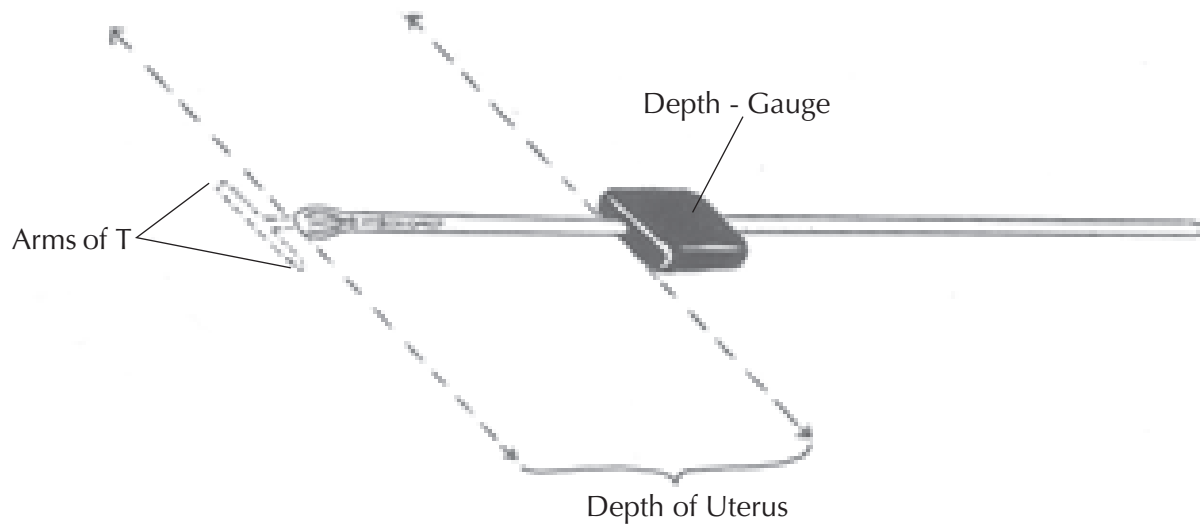


Figure 6: Loaded inserter carefully lifted

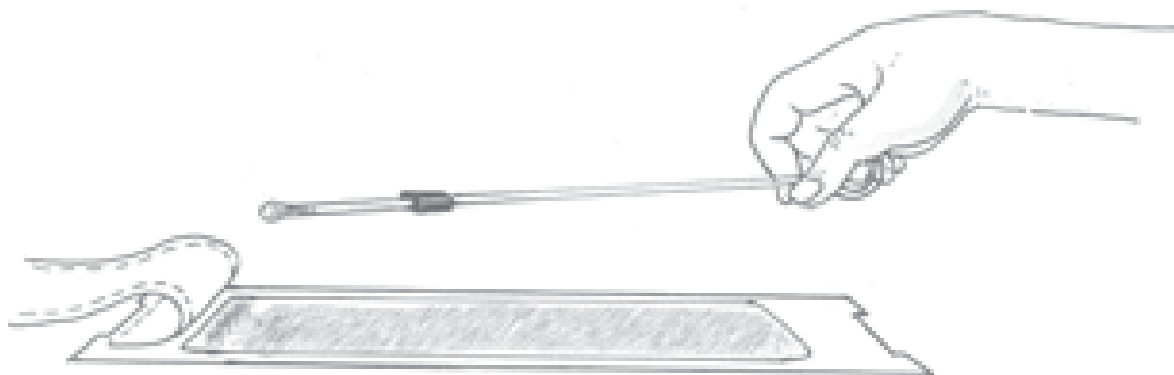




Figure 7 Loaded inserter at the fundus with the blue depth-gauge at the cervix.

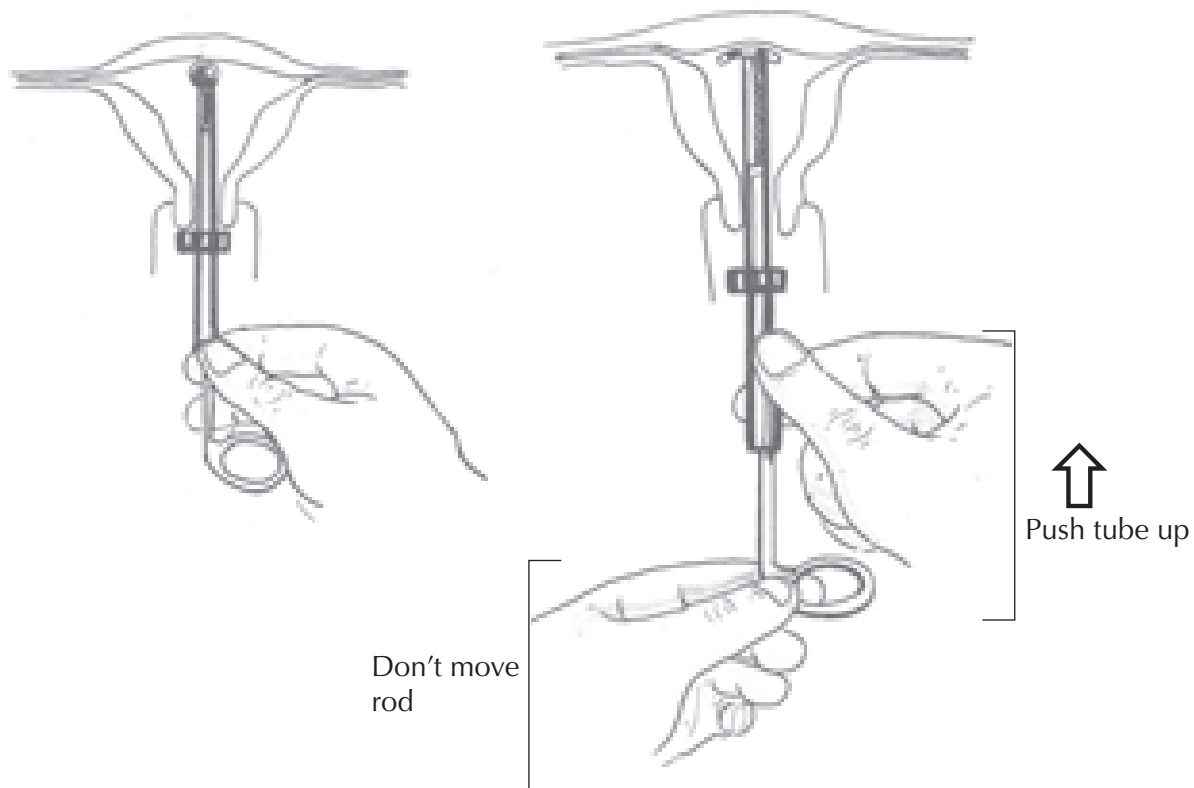


Fig. 8 Ensuring the IUCD is high in the uterus

## Supporting the user

Post insertion client instructions:

- Tell woman to expect some cramping and pain for a few days after insertion.
- Suggest ibuprofen (200–400 mg), paracetamol (325–1000 mg), or other pain reliever as needed.
- Tell client to expect some bleeding or spotting immediately after insertion. This may continue for 3 to 6 months.
- Suggest that woman can check her IUCD strings from time to time, especially in the first few months and after monthly bleeding, to confirm that her IUCD is still in place.
- Discuss how to remember the date to return.
- Give each woman the following information in writing on a reminder card and explain:
  - The type of IUCD she has
  - Date of IUCD insertion
  - Month and year when IUCD will need to be removed or replaced
  - Where to go if she has problems or questions with her IUCD

IUD Reminder Card	
Client's name:	_____
Type of IUD:	_____
Date Inserted:	_____
Remove or replace by:	Month: <input type="text"/> Year: <input type="text"/>
If you have any problems or questions go to:	
(name and location of facility)	

## Follow-up and Reasons to Return

A follow-up visit after her first monthly bleeding or 6 weeks after IUCD insertion is recommended.

### Reasons to Return:

Assure every client that she is welcome to come back any time—for example, if she has problems, questions, or wants another method, or she has a major change in health status.

Also if:

- She thinks the IUCD might be out of place. For example, she:
  - Feels the strings are missing.
  - Feels the hard plastic of an IUCD that has partially come out.
- She has symptoms of pelvic inflammatory disease (increasing or severe pain in the lower abdomen, pain during sex, unusual vaginal discharge, fever, chills, nausea, and/or vomiting), especially in the first 20 days after insertion.
- She thinks she might be pregnant.

### General health advice:

Anyone who suddenly feels that something is seriously wrong with her health should immediately seek medical care from a nurse or doctor. Her contraceptive method is most likely not the cause of the condition, but she should tell the nurse or doctor what method she is using.

## Helping Continuing Clients

### Post-Insertion Follow-Up Visit (6 Weeks)

1. Ask how the client is doing with the method and whether she is satisfied. Ask if she has any questions or anything to discuss.
2. Ask especially if she is concerned about bleeding changes. Give her any information or help that she needs

3. Ask her if she has:
  - Increasing or severe abdominal pain or pain during sex or urination
  - Unusual vaginal discharge
  - Fever or chills
  - Signs or symptoms of pregnancy
  - Not been able to feel strings (if she has checked them)
  - Felt the hard plastic of an IUCD that has partially come out
4. A routine pelvic examination at the follow-up visit is not required. It may be appropriate in some settings or for some clients, however. Conduct a pelvic examination particularly if the client's answers lead you to suspect:
  - A sexually transmitted infection or pelvic inflammatory disease
  - The IUCD has partially or completely come out

#### Any Visit

- Ask how the client is doing with the method and about bleeding changes
- Ask a long-term client if she has had any new health problems. Address problems as appropriate. See new health problems that may require switching methods
- Ask a long-term client about major life changes that may affect her needs—particularly plans for having children and STI/HIV risk. Follow up as needed
- Remind her how much longer the IUCD will protect her from pregnancy

## Removing IUCD

### Procedure

- Prepare self, materials and client
- Assemble materials and prepare room
- Establish and maintain positive provider-client interpersonal relationship throughout the procedure
- Ask the client how she feels generally
- Review client's previous information in RCH No. 5 FP card
- Confirm the reason for removal of IUCD
- Ask client to empty her bladder
- Assist client to get on the couch.

## Removing the IUCD

- Swab the vulva as necessary
- Insert vaginal speculum and screw firmly
- Clean the cervix with antiseptic
- Place the tenaculum at the imaginary 10 o'clock and 2 o'clock sites at the upper lip of the cervix. If using a Vulsellum forceps, pinch the cervix.

- Grasp the strings close to the cervix with sponge-holding or haemostatic forceps
- Pull slowly, gently and firmly
- Show the removed IUCD to the patient
- Decontaminate the removed IUCD in 0.5% chlorine solution and then place in the contaminated waste container
- If the strings break off, try to grasp the device, if visible, with the forceps and remove it.
- If the device cannot be removed, tactfully explain to the client and refer client for further management
- Remove the tenaculum and speculum gently and decontaminate in 0.5% chlorine solution
- Offer a sanitary pad
- Ask the client to get off the couch
- Manage any pain or discomfort or anxiety by reassurance and analgesics
- Follow steps of inserting the IUCD, if client wants another IUCD re-inserted

### Record Client's Information

- Record client's information in RCH No. 5: FP card and HMIS book 8
- Give client a return date
- Bid farewell to client

### Switching From an IUCD to another Method

These guidelines ensure that the client is protected from pregnancy without interruption when switching from a copper-bearing IUCD to another method. See also "When to Start" section for each method.

Switching to	When to start
Combined oral contraceptives (COCs), progestin-only pills (POPs), progestin-only injectables, or implants	<p>If starting during the first 7 days of monthly bleeding (first 5 days for COCs and POPs), start the hormonal method now and remove the IUCD. No need for a backup method.</p> <p>If starting after the first 7 days of monthly bleeding (after the first 5 days for COCs and POPs) and she has had sex since her last monthly bleeding, start the hormonal method now. It is recommended that the IUCD be kept in place until her next monthly bleeding.</p> <p>If starting after the first 7 days of monthly bleeding (after the first 5 days for COCs and POPs) and she has not had sex since her last monthly bleeding, the IUCD can stay in place and be removed during her next monthly bleeding, or the IUCD can be removed and she can use a backup method for the next 7 days (2 days for POPs).</p>
Male or female condoms, withdrawal	Immediately for the next time she has sex after the IUCD is removed.
Fertility awareness methods	Immediately after the IUCD is removed.

Bilateral Tubal ligation (BTL)	<p>If starting during the first 7 days of monthly bleeding, remove the IUCD and perform the (BTL) procedure. No need for a backup method.</p> <p>If starting after the first 7 days of monthly bleeding, perform the sterilization procedure. The IUCD can be kept in place until her follow-up visit or her next monthly bleeding. If a follow-up visit is not possible, remove the IUCD at the time of sterilization. No need for a backup method.</p>
Vasectomy	<p>Any time</p> <p>The woman can keep the IUCD for 3 months after her partner's vasectomy to prevent pregnancy until the vasectomy is fully effective.</p>

## Managing Any Problems using the SOAP Approach

### The SOAP Approach

**Subjective:** It is the history given:

This is information the client describes on what happened or how she is feeling e.g. lower abdominal pain. It comes out if the provider asks open-ended questions, shows care, concern and listens actively in privacy and confidentiality is assured.

**Objective:** Provider's findings

These are findings the provider notes after examining the client in relation to subjective information e.g. vaginal discharge, abdominal tenderness or abdominal tenderness (e.g. speculum and pelvic bimanual examination). Take note to pay special attention to confirm and explore client's subjective information.

**Assessment:** Analysis of history and physical examination findings:

This is the service provider's impression on the possible causes of the client's problem after looking at the subjective information and objective findings e.g. assessment can be STI, PID etc.

**Plan:** Is purely management:

This refers to the plan the service provider develops to manage the findings e.g. treat according to guidelines or flowcharts.

Component	Action	Skills Required
Subjective information:	History taking.	Listen
Objective findings:	- Examination and investigations.	Look, Feel, Test.
Assessment:	- Review findings, reach conclusions. - Share findings. - Explain next steps	- Analyse, Interpret,
Plan:	- Manage problem. - Share management plan return visits.	Diagnose.

<p>1. Subjective information history/information obtained from clients</p>	<p>LMP: Normal in timing, amount and duration.</p> <ul style="list-style-type: none"> <li>◆ Bleeding: when, how long, amount, clots.</li> <li>◆ Pain, fever.</li> <li>◆ Morning sickness.</li> <li>◆ Breast tingling.</li> <li>◆ FP method being used.</li> <li>◆ Any defaulting or delay.</li> </ul>
<p>2. Objective findings</p>	<ul style="list-style-type: none"> <li>◆ Check for signs of anaemia.</li> <li>◆ Check for signs of pregnancy. <ul style="list-style-type: none"> <li>- Breast tenderness.</li> <li>- Pigmentation of the breast areola.</li> </ul> </li> <li>◆ Abdominal examination. <ul style="list-style-type: none"> <li>- Linea nigra.</li> <li>- Abdominal distension.</li> </ul> </li> <li>◆ Palpation. <ul style="list-style-type: none"> <li>- Rebound tenderness.</li> <li>- Pain on touch.</li> <li>- Mass.</li> </ul> </li> <li>◆ Pelvic examination. <ul style="list-style-type: none"> <li>- Inspection: Vaginal discharge - type, colour, consistency, odour.</li> <li>- Speculum examination: Bleeding, sources of bleeding, signs of pregnancy, any products of conception.</li> <li>- Colour of the cervix.</li> </ul> </li> <li>◆ Bimanual examination: <ul style="list-style-type: none"> <li>- Cervix: Soft/hard, os - open/closed.</li> <li>- Uterus: Size, consistency, mobility.</li> <li>- Adnexa: Tenderness, any palpable mass, pulsation: in cervical fornices more blood supply.</li> <li>- Urethra: Discharge.</li> </ul> </li> </ul>

## Problems Reported As Side Effects or Complications

May or may not be due to the method.

- Problems with side effects or complications affect women’s satisfaction and use of IUCDs. They deserve the provider’s attention. If the client reports any side effects or complications, listen to her concerns, give her advice, and, if appropriate, treat.
- Offer to help her choose another method—now, if she wishes, or at a later date if problems cannot be overcome.

Heavy or prolonged menstrual bleeding (twice as much as usual or longer than 8 days)

- Reassure her that many women using IUCDs experience heavy or prolonged menstrual bleeding. It is generally not harmful and usually lessens or stops after the first several months of use.
- For modest short-term relief she can try (one at a time):
  - Tranexamic acid (1500 mg) 3 times daily for 3 days, then 1000 mg once daily for 2 days, beginning when heavy bleeding starts.
  - Nonsteroidal anti-inflammatory drugs (NSAIDs) such as ibuprofen (400 mg) or indomethacin (25 mg) 2 times daily after meals for 5 days, beginning when heavy bleeding starts. Other NSAIDs—except aspirin—also may provide some relief of heavy or prolonged bleeding.
- Provide iron tablets if possible and tell her it is important for her to eat foods containing iron.
- If heavy or prolonged bleeding continues or starts after several months of normal bleeding or long after the IUCD was inserted, or if you suspect that something may be wrong for other reasons, consider underlying conditions unrelated to method use.

Irregular bleeding (bleeding at unexpected times that bothers the client)

- Reassure her that many women using IUCDs experience irregular bleeding. It is not harmful and usually lessens or stops after the first several months of use.
- For modest short-term relief she can try NSAIDs such as ibuprofen (400 mg) or indomethacin (25 mg) 2 times daily after meals for 5 days, beginning when irregular bleeding starts.
- If irregular bleeding continues or starts after several months of normal bleeding, or you suspect that something may be wrong for other reasons, consider underlying conditions unrelated to method use.

Cramping and pain

- She can expect some cramping and pain for the first day or two after IUCD insertion.
- Explain that cramping also is common in the first 3 to 6 months of IUCD use, particularly during monthly bleeding. Generally, this is not harmful and usually decreases over time.
- Suggest aspirin (325–650 mg), ibuprofen (200–400 mg), paracetamol (325–1000 mg), or other pain reliever. If she also has heavy or prolonged bleeding, aspirin should not be used because it may increase bleeding.

If cramping continues and occurs outside of monthly bleeding:

- Evaluate for underlying health conditions and treat or refer.
- If no underlying condition is found and cramping is severe, discuss removing the IUCD.
- If the removed IUCD looks distorted, or if difficulties during removal suggest that the IUCD was out of proper position, explain to the client that she can have a new IUCD that may cause less cramping.

Possible anaemia

- The copper-bearing IUCD may contribute to anaemia if a woman already has low iron blood stores before insertion and the IUCD causes heavier monthly bleeding.

- Pay special attention to IUCD users with any of the following signs and symptoms:
  - Inside of eyelids or underneath fingernails looks pale, pale skin, fatigue or weakness, dizziness, irritability, headache, ringing in the ears, sore tongue, and brittle nails.
  - If blood testing is available, haemoglobin less than 9 g/dl or haematocrit less than 30.
- Provide iron tablets if possible.
- Tell her it is important to eat foods containing iron, such as meat and poultry (especially beef and chicken liver), fish, green leafy vegetables, and legumes (beans, bean curd, lentils, and peas).

#### Partner can feel IUCD strings during sex

- Explain that this happens sometimes when strings are cut too short.
- If partner finds the strings bothersome, describe available options:
  - Strings can be cut even shorter so they are not coming out of the cervical canal. Her partner will not feel the strings, but the woman will no longer be able to check her IUCD strings.
  - If the woman wants to be able to check her IUCD strings, the IUCD can be removed and a new one inserted. (To avoid discomfort, the strings should be cut so that 3 centimetre hang out of the cervix.)
  - Strings often soften over time, thus the partner may not feel them after a while (i.e., if possible to tolerate, no additional action required).

#### Severe pain in lower abdomen (suspected PID)

- Some common signs and symptoms of PID often also occur with other abdominal conditions, such as ectopic pregnancy. If ectopic pregnancy is ruled out, assess for PID.
- If possible, do abdominal and pelvic examinations.
- If a pelvic examination is not possible, and she has a combination of the following signs and symptoms in addition to lower abdominal pain, suspect PID:
  - Unusual vaginal discharge
  - Fever or chills
  - Pain during sex or urination
  - Bleeding after sex or between monthly bleeding
  - Nausea and vomiting
  - A tender pelvic mass
  - Pain when the abdomen is gently pressed (direct abdominal tenderness) or when gently pressed and then suddenly released (rebound abdominal tenderness)
- Treat PID or immediately refer for treatment:
  - Because of the serious consequences of PID, health care providers should treat all suspected cases, based on the signs and symptoms above. Treatment should be started as soon as possible. Treatment is more effective at preventing long-term complications when appropriate antibiotics are given immediately.
  - Treat for Gonorrhoea, Chlamydia, and anaerobic bacterial infections. Counsel the client about condom use and, if possible, give her condoms.



- There is no need to remove the IUCD if she wants to continue using it (client should simply be treated for PID). If client wants to discontinue IUCD use, remove it after starting antibiotic treatment.

#### Severe pain in lower abdomen (suspected ectopic pregnancy)

- Many conditions can cause severe abdominal pain. Be particularly alert for additional signs or symptoms of ectopic pregnancy, which is rare but can be life-threatening.
- In the early stages of ectopic pregnancy, symptoms may be absent or mild, but eventually they will become severe. A combination of these signs or symptoms should increase suspicion of ectopic pregnancy:
  - Unusual abdominal pain or tenderness
  - Abnormal vaginal bleeding or no monthly bleeding—especially if this is a change from her usual bleeding pattern
  - Light-headedness or dizziness
  - Fainting
- If ectopic pregnancy or other serious health condition is suspected, refer at once for immediate diagnosis and care.
- If the client does not have these additional symptoms or signs, assess for pelvic inflammatory disease

#### Suspected uterine puncturing (perforation)

If puncturing is suspected at the time of insertion or sounding of the uterus, stop the procedure immediately (and remove the IUCD if inserted). Observe the client in the clinic carefully:

- For the first hour, keep the woman at bed rest and check her vital signs (blood pressure, pulse, respiration, and temperature) every 5 to 10 minutes.
- If the woman remains stable after one hour, check for signs of intra-abdominal bleeding, such as low haematocrit or haemoglobin, if possible, and her vital signs. Observe for several more hours. If she has no signs or symptoms, she can be sent home, but she should avoid sex for 2 weeks. Help her choose another method.
- If she has a rapid pulse and falling blood pressure, or new pain or increasing pain around the uterus, refer her to a higher level of care.
- If uterine perforation is suspected within 6 weeks after insertion or if it is suspected later and is causing symptoms, refer the client for evaluation to a clinician experienced at removing such IUCDs.

#### IUCD partially comes out (partial expulsion)

- If the IUCD partially comes out, remove the IUCD. Discuss with the client whether she wants another IUCD or a different method. If she wants another IUCD, she can have one inserted at any time it is reasonably certain she is not pregnant. If the client does not want to continue using an IUCD, help her choose another method.

#### IUCD completely comes out (complete expulsion)

- If the client reports that the IUCD came out, discuss with her whether she wants another IUCD or a different method. If she wants another IUCD, she can have one inserted at any time it is reasonably certain she is not pregnant.

- If complete expulsion is suspected and the client does not know whether the IUCD came out, refer for x-ray or ultrasound to assess whether the IUCD might have moved to the abdominal cavity. Give her a backup method to use in the meantime.

Missing strings (suggesting possible pregnancy, uterine perforation, or expulsion)

- Ask the client:
  - Whether and when she saw the IUCD come out
  - When she last felt the strings
  - When she had her last monthly bleeding
  - If she has any symptoms of pregnancy
  - If she has used a backup method since she noticed the strings were missing
- Always start with minor and safe procedures and be gentle. Check for the strings in the folds of the cervical canal with forceps. About half of missing IUCD strings can be found in the cervical canal.
- If strings cannot be located in the cervical canal, either they have gone up into the uterus or the IUCD has been expelled unnoticed. Rule out pregnancy before attempting more invasive procedures. Refer for evaluation. Give her a backup method to use in the meantime, in case the IUCD came out.

### **New Problems That May Require Switching Methods**

May or may not be due to method.

Unexplained vaginal bleeding (that suggests a medical condition not related to the method)

- Refer or evaluate by history or pelvic examination. Diagnose and treat as appropriate.
- She can continue using the IUCD while her condition is being evaluated.
- If bleeding is caused by sexually transmitted infection or pelvic inflammatory disease, she can continue using the IUCD during treatment.

Suspected pregnancy

- Assess for pregnancy, including ectopic pregnancy.
- Explain that an IUCD in the uterus during pregnancy increases the risk of preterm delivery or miscarriage, including infected (septic) miscarriage during the first or second trimester, which can be life-threatening.
- If the woman does not want to continue the pregnancy, counsel her according to program guidelines.

If she continues the pregnancy:

- Advise her that it is best to remove the IUCD.
- Explain the risks of pregnancy with an IUCD in place. Early removal of the IUCD reduces these risks, although the removal procedure itself involves a small risk of miscarriage.
- If she agrees to removal, gently remove the IUCD or refer for removal.

- Explain that she should return at once if she develops any signs of miscarriage or septic miscarriage (vaginal bleeding, cramping, pain, abnormal vaginal discharge, or fever).
- If she chooses to keep the IUCD, her pregnancy should be followed closely by a nurse or doctor. She should see a nurse or doctor at once if she develops any signs of septic miscarriage.
- If the IUCD strings cannot be found in the cervical canal and the IUCD cannot be safely retrieved, refer for ultrasound, if possible, to determine whether the IUCD is still in the uterus. If it is, or if ultrasound is not available, her pregnancy should be followed closely. She should seek care at once if she develops any signs of septic miscarriage.



## Chapter 13:

# Female and Male Voluntary Surgical Contraception

### Overview:

This chapter will cover procedures necessary for counselling clients about female and male voluntary surgical contraception (VSC), such as bilateral tubal ligation and vasectomy. Voluntary surgical contraception is intended to provide life-long, permanent and very effective protection from pregnancy for individuals and couples who decided they want no more children. The chapter will focus on:

- Definition of female and male VSC
- Effectiveness
- Characteristics
- Overview of eligibility criteria
- Correcting misconceptions and misunderstandings
- Performing Bilateral Tubal Ligation (BTL)/Mini-laparotomy Under Local anaesthesia (ML/LA)
- Post operative instructions

*Note that more procedures and issues related to the surgical procedures itself will be covered in a separate document intended only for clinicians trained in providing Female VSC*

## I. Female Voluntary Surgical Contraception

### What Is Female VSC?

- Permanent contraception for women who will not want more children.
- Common surgical approach in Tanzania is minilaparotomy with bilateral tubal ligation. It involves making a small incision in the abdomen. The fallopian tubes are brought to the incision to be tied and cut.
- Also called female sterilization, tubal sterilization, tubectomy and bi-tubal ligation.

### Mechanism of Action of Female VSC

Because the fallopian tubes are blocked or cut, egg released from the ovary cannot move down the tubes and unite with sperm.

### Effectiveness of Female VSC

- Highly effective 0.5 pregnancies per 100 women during first year of use( 1 in every 200 women)
- Risk of failure (pregnancy) is 18.5/1000 or almost 2% at 10 years)

### Characteristics of Female VSC:

- Highly effective
- safe
- Permanent
- Does not interfere with intercourse
- Simple surgery usually performed under local anesthesia with moderate sedation and as an out patient
- No long-term side effects
- Good for client if pregnancy would pose a serious health risk
- No change in sexual function (no effect on hormone production by ovaries)
- Ideal for those desiring no more children
- Quick recovery
- Cost-effective
- No need for partner compliance
- No effect on breast cancer risk, endometrial cancer risk and bone density
- Requires trained service providers
- Short-term discomfort and pain following procedure
- Potential risk of complications, especially if general anesthesia is used
- Must be considered permanent (success of reversal cannot be guaranteed)
- Client may regret later (age < 35)
- Expense at time of procedure
- Does not protect against STIs (e.g. HBV, HIV)

## Correcting Misunderstandings about Female VSC:

- Does not make women weak.
- Does not cause lasting pain in back, uterus, or abdomen.
- Does not remove a woman's uterus or lead to a need to have it removed – female VSC is NOT a castration.
- Does not cause hormonal imbalances.
- Does not cause heavier bleeding or irregular bleeding or otherwise change women's menstrual cycles.
- Does not cause any changes in weight, appetite, or appearance.
- Does not change women's sexual behaviour or sex drive.
- Substantially reduces the risk of ectopic pregnancy.

## Who Can Have Female VSC?

With proper **counselling and informed consent**, any woman of reproductive age can have female VSC safely, including women who:

- Who want highly effective, permanent protection against pregnancy
- For whom pregnancy would pose a serious health risk
- Who are certain that they have achieved their desired family size
- Who understand and consent to procedure
- Have no children or few children
- Are not married
- Do not have husband's permission
- Are young
- Just gave birth (within the last 7 days)
- Are breastfeeding
- Are infected with HIV, whether or not on antiretroviral therapy
- Are certain they have achieved the desired family size
- May risk serious health problems if they get pregnant
- Understand and voluntarily follow informed choice/consent procedure.

**In some of these situations, especially careful counselling is important to make sure the woman will not regret her decision.**

## Screening Women for Medical Eligibility for VSC

No medical conditions prevent woman from using VSC. However some known medical conditions may limit when, where or how the female VSC procedure should be performed. All conditions are classified in 4 categories.

- **ACCEPT** – means there is no medical reason to deny female VSC to a person with this condition.

- **CAUTION** - means the procedure can be performed in a routine setting but with extra preparation and precautions, depending on the condition.
- **DELAY** - means postpone female VSC. These conditions must be treated and resolved before female VSC can be performed. Give the client another method to use until the procedure can be performed.
- **SPECIAL** - means special arrangements should be made to perform the procedure in a setting with an experienced surgeon and staff, equipment to provide general anaesthesia, and other backup medical support. For these conditions, the capacity to decide on the most appropriate procedure and anaesthesia regimen also is needed. Give the client another method to use until the procedure can be performed.

Providers who **counsel and refer** women for VSC should be aware of the conditions which require procedure to be delayed. Providers who perform female VSC procedure will screen women for all conditions, including those which require caution or special arrangements.

### **Conditions Which Require Female VSC to be DELAYED:**

- Current pregnancy
- 7-42 days postpartum
- Postpartum after a pregnancy with severe pre-eclampsia or eclampsia
- Serious postpartum or postabortion complications (such as infection, haemorrhage or trauma) except uterine rupture or perforation which is done under special arrangements.
- A large collection of blood in the uterus
- Unexplained vaginal bleeding that suggests an underlying medical condition
- Pelvic inflammatory disease
- Purulent cervicitis, chlamydia or gonorrhoea
- Pelvic cancers ( treatment may make her sterile in any case )
- Malignant trophoblast disease
- Heart disease due to blocked or narrowed arteries
- Blood clots in deep veins of legs or lungs
- Gallbladder disease with symptoms
- Active viral hepatitis
- Severe iron-deficiency anaemia (haemoglobin less than 7 g/dl)
- Lung disease (bronchitis or pneumonia)
- Systemic infection or significant gastroenteritis
- Abdominal skin infection
- Undergoing abdominal surgery for emergency or infection, or major surgery with prolonged immobilization



### **VSC for Women With HIV:**

- Women who are infected with HIV, have AIDS, or are on antiretroviral (ARV) therapy can safely undergo Female VSC procedure. Special arrangements are needed to perform female sterilization on a woman with AIDS.
- Urge these women to use condoms in addition to Female VSC. Used consistently and correctly, condoms help prevent transmission of HIV and other STIs.
- No one should be coerced or pressured into having Female VSC, and that includes women with HIV.

### **Performing Bilateral Tubal Ligation (BTL)/Mini-laparotomy Under Local anaesthesia (ML/LA)**

#### **Pre operative assessment**

- Medical history
  - Check list can be used
  - General information such as
    - ◆ Age, occupation, level of education
  - Obstetric and gynecologic history
    - ◆ Pregnancies, parity, number of living children, pelvic infection, contraceptive use, LNMP
  - Medical & surgical history such as
    - ◆ Respiratory problem, cardiac illness, previous surgery (pelvic or abdominal), allergy to drugs
- Physical examination
  - General condition and nutritional status
  - Weight
  - Vital signs
  - Auscultation of the lung and heart
  - Abdominal examination
  - Pelvic examination (for interval procedure)
  - Other examinations as indicated

#### **Pre operative instructions**

- Don't eat solid food for eight hours before surgery
- Bring along a friend or relative to escort home afterwards
- Bath thoroughly especially the belly and the genital area
- Wear clean loose fitting clothing when coming to the clinic

## **Obtaining Informed Consent**

Informed consent is the client's acceptance, agreement, or permission given under his or her own free will after making an informed decision

### **7 Elements of Informed consent**

1. The understanding that this is a surgical procedure
2. The knowledge of the availability of temporary methods
3. An understanding of the benefits and risks of the procedure, including the small risk of failure
4. The understanding that it is intended to be permanent
5. The understanding that if the VSC is successful, the client will have no more children
6. The understanding that VSC does not protect the client or his/her partner from infection with sexually transmitted infections, including HIV/AIDS
7. Knowledge of the option to decide against the procedure at any time before the operation

## **Clinical Procedure for performing ML/LA**

### **Standard operating instruments**

- 1 antiseptic solution cup
- 1 dressing forceps, standard pattern, 5"
- 1 tissue forceps, delicate pattern, 5.5"
- 2 Kelly artery forceps, straight, 5.5"
- 2 mosquito forceps, delicate, curved, 5"
- 2 Allis intestinal forceps, delicate, 6", 3x4 teeth
- 2 baby Babcock intestinal forceps, 7.5"
- 1 Foerster sponge forceps, straight, 9.5"
- 1 Mayo-Hegar needle holder, 7"
- 2 Richardson-Eastman retractors, same small size (for suprapubic procedure)
- 2 Army-Navy retractors, double-ended (for subumbilical procedure)
- 1 Metzenbaum scissors, curved, 7"
- 1 Mayo operating scissors, curved, 6.75"
- 1 surgical handle, #3, graduated in cm

### **Instruments for inserting the uterine**

#### **elevator**

- 1 Graves speculum, medium
- 1 Foerster sponge forceps, curved, 9.5"
- 1 Schroeder tenaculum forceps, 10"

### **Specialized instruments**

- 1 Ramathobodi uterine elevator, 28 cm in length
- 1 Ramathobodi tubal hook

### **Operational instruments**

- 1 kidney tray

### **Alternative instruments**

- 1 Jackson vaginal retractor, 1.5 x 3" (deep blade)

### ***Procedural steps***

- **Inserting uterine elevator.**
  - Inserting the elevator without touching the walls of the vagina.
  - Elevate the uterus so that the fundus can be palpated with the hand.
  - Rotating the uterus when it is retroverted.
- **Prepare operation site:**
  - Scrub and wear sterile gloves.
  - Prepare the abdomen with antiseptic and drape client with sterile towel.
- **Infiltration of the local Anaesthesia:**
  - Achieve an anaesthetic block in a diamond shape that infiltrates all layers from skin to peritoneum.
  - Augment Anaesthesia at the focal and peritoneal layers, if necessary.
  - Drip lignocaine on each tube for additional Anaesthesia.
  - Use lignocaine 1% without adrenaline not exceeding 5mg/kg (20 ml for 40 kg body weight).Maximum dose of 20 mls should never be exceeded.
- **Enter the abdomen:**
  - Incise the skin 2-3 cm above pubis symphysis.
  - Enter layer by layer.
  - Look for translucence of peritoneum.
  - Ensure haemostasis.
- **Deliver the fallopian tubes:**
  - Gently press the handle of the uterine elevator downward.
  - Rotate the elevator handle to bring the first fallopian tube under the insertion site.
  - Insert tubal hook and grab the fallopian tube with babcock forceps.
  - Drip 2-3 mls of 1% lignocaine on each fallopian tube.

- **Methods of tubal occlusion:**
  - Modified Pomeroy method of occlusion.
  - Parkland method of occlusion.
  - Clipping method of occlusion.
- **Wound closure**
  - Close the incision in layers.
  - Dress the wound.
  - Remove uterine elevator.
  - Prescribe drugs if necessary.

### **Post-partum ML/LA**

Same as in interval **ML/LA** except:

- Incision site is below umbilicus
- No use of uterine elevator.

#### ***Instruments used for inserting the uterine elevator***

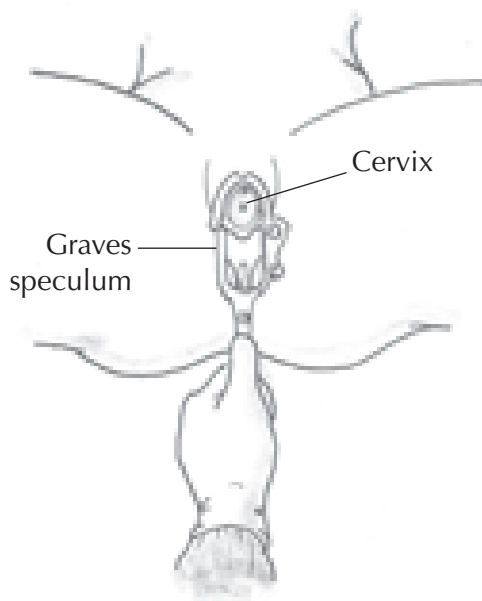


**Instruments used for performing ML/LA**

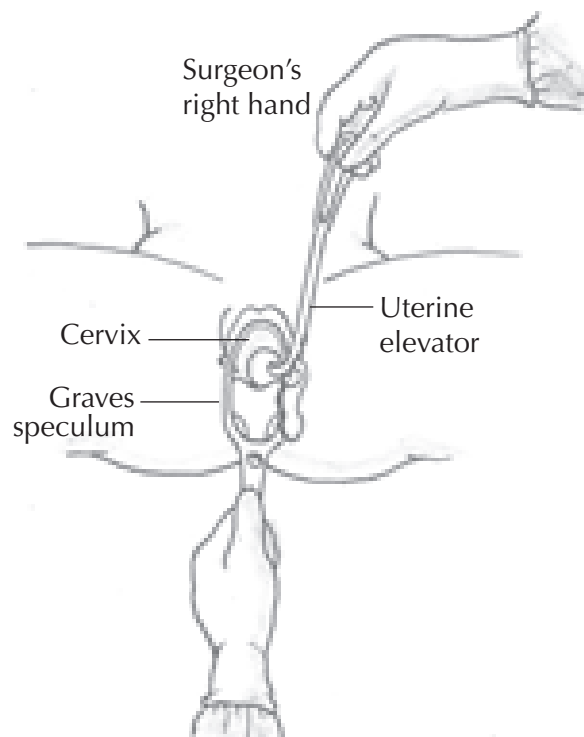


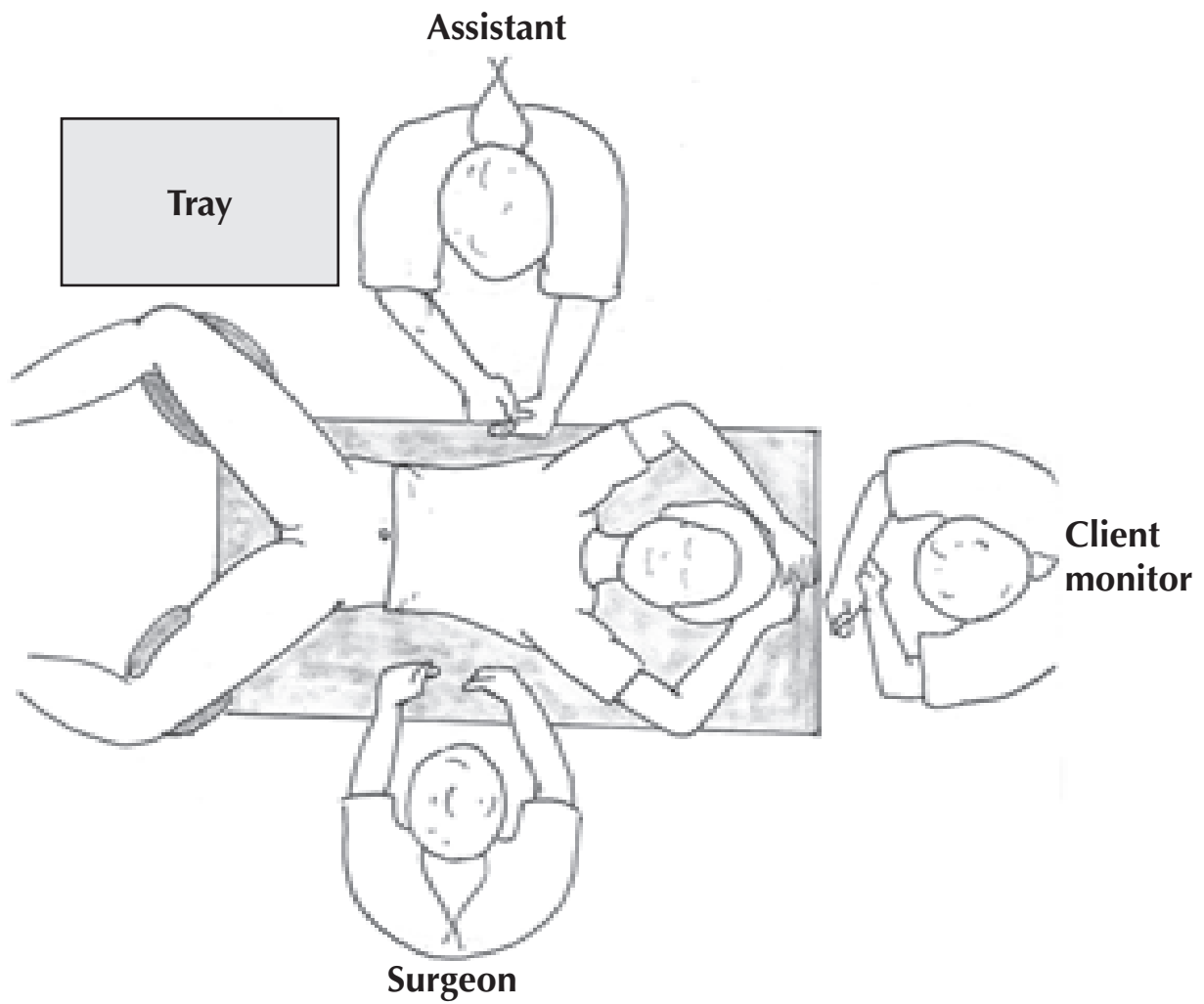
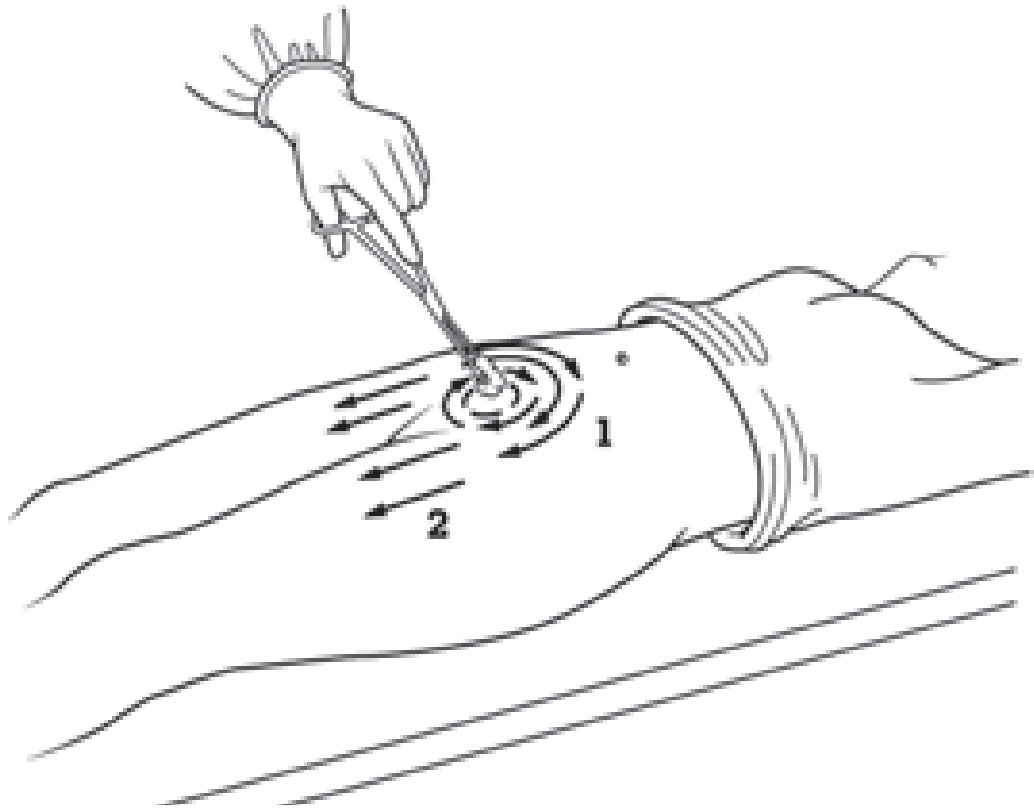
**Inserting the uterine elevator**

(a) Using a Grave speculum to visualize the cervix



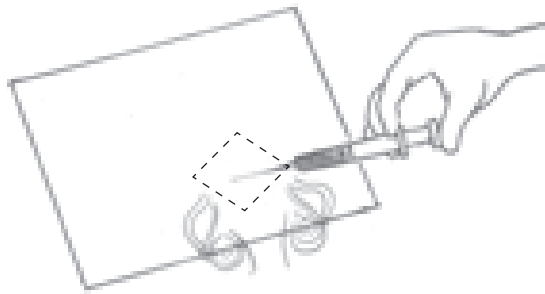
(b) Passing the uterine elevator into the cervix without letting it touch the vaginal walls



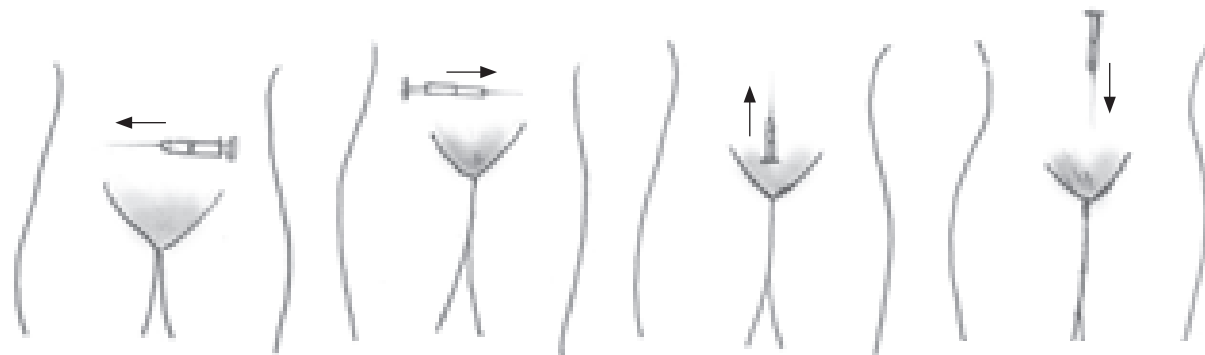


## Field block using the diamond - shape technique

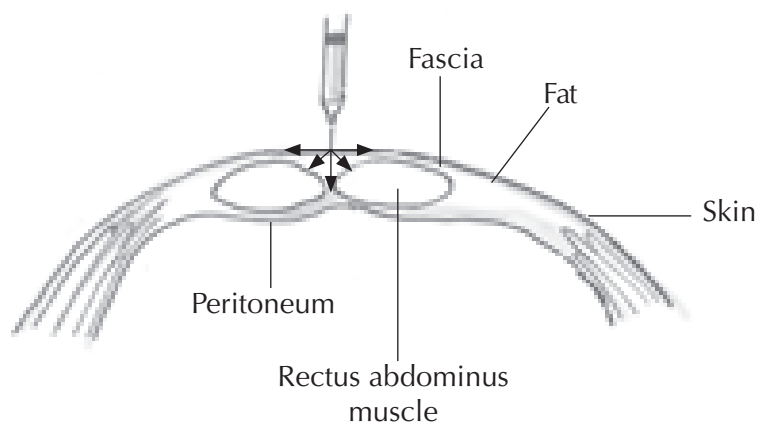
(a) Entry of the needle at the incision site



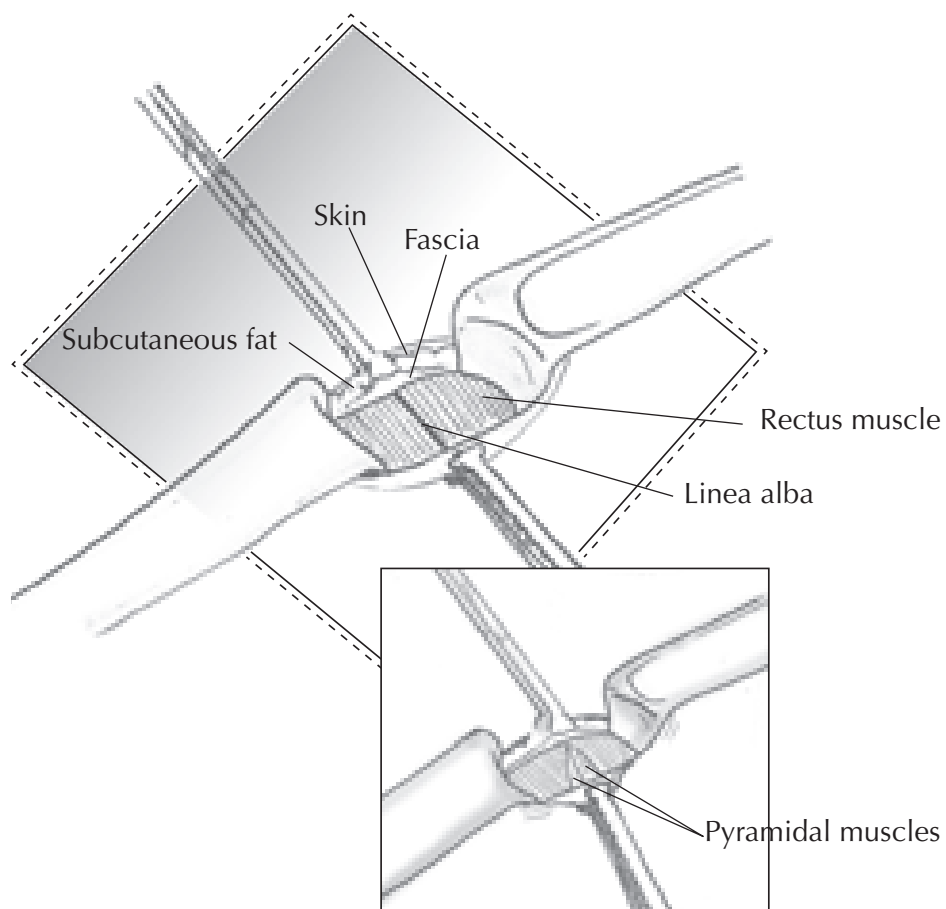
(b) Skin infiltration



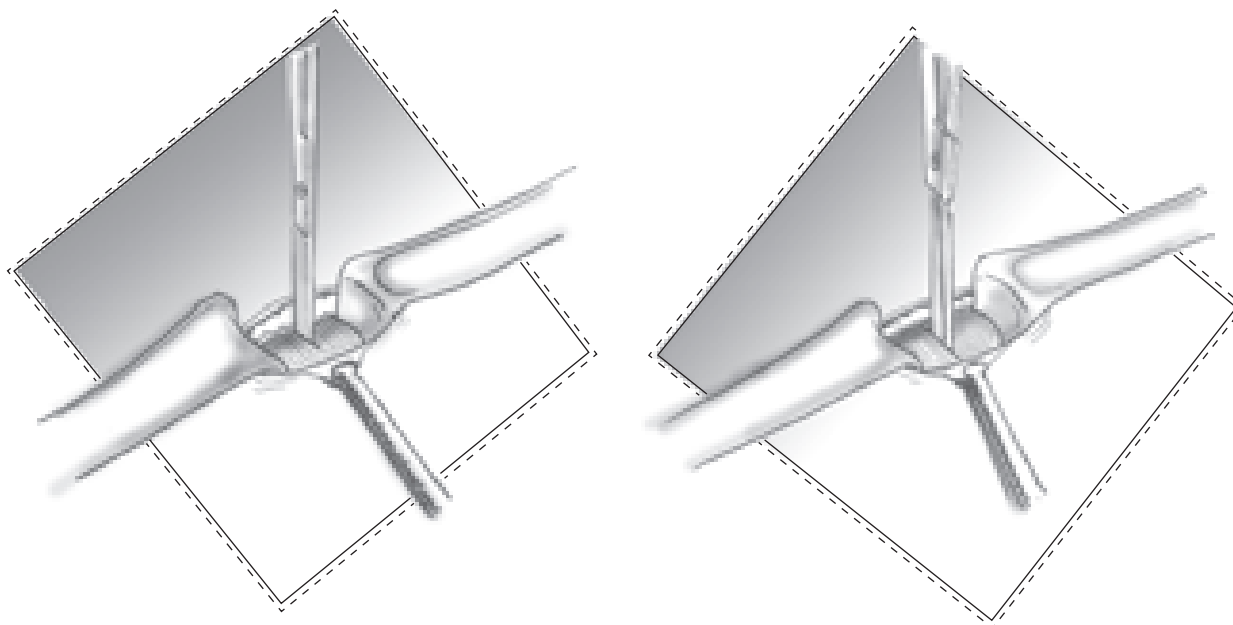
(c) Infiltration of the different layers



## Entering the abdomen: Visualizing the muscle layers

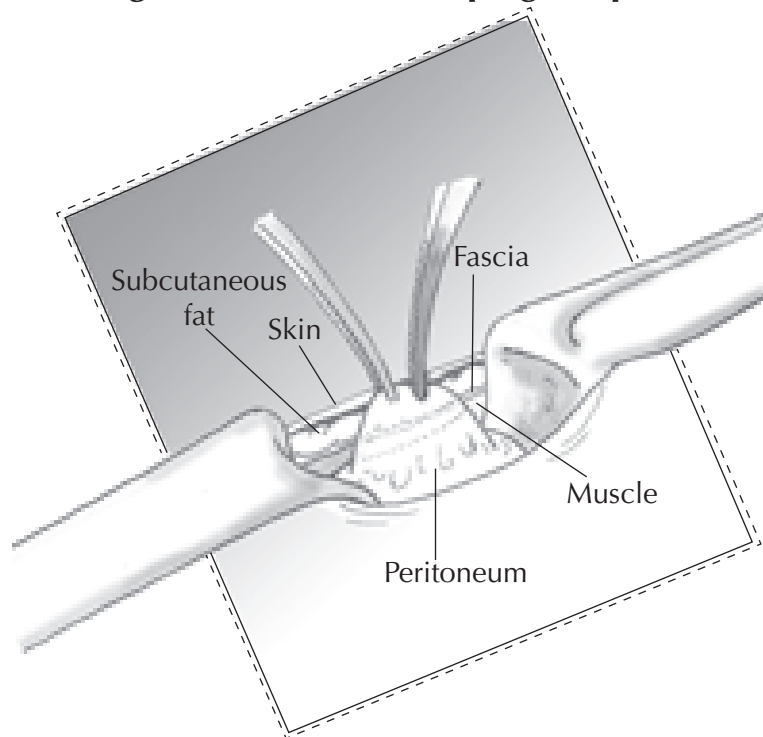


## Entering the abdomen: Opening the rectus muscles

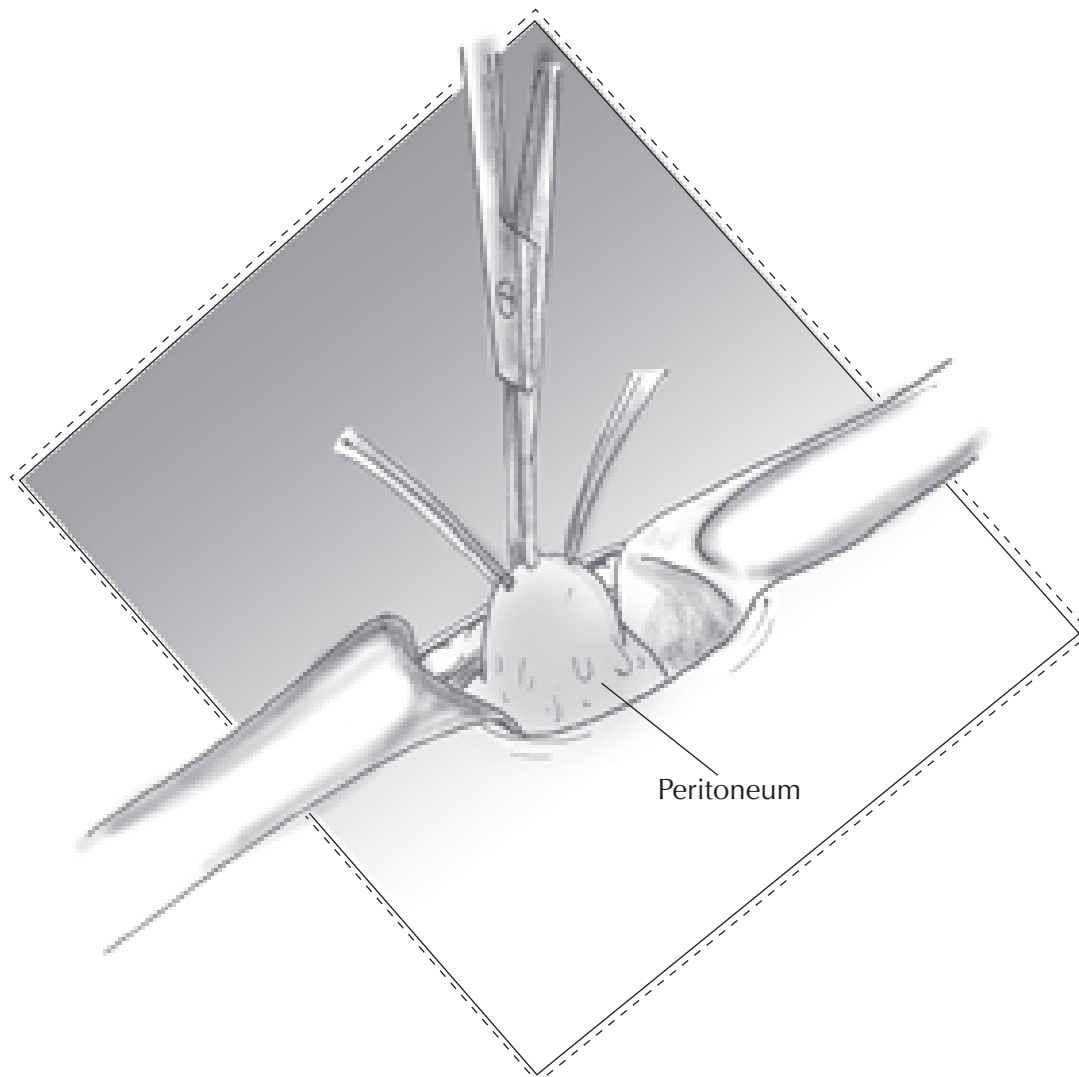




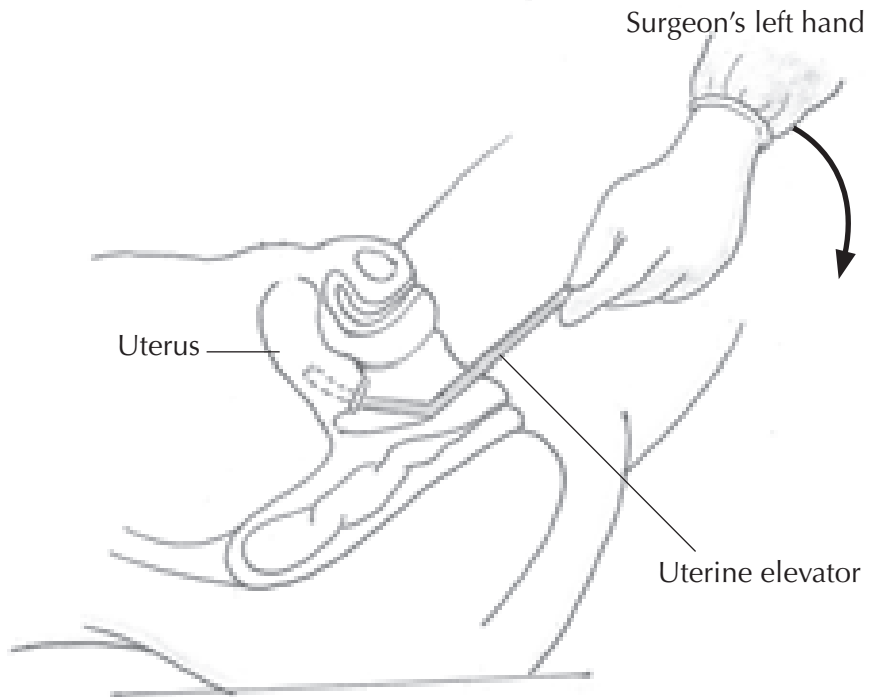
## Entering the abdomen: Grasping the peritoneum



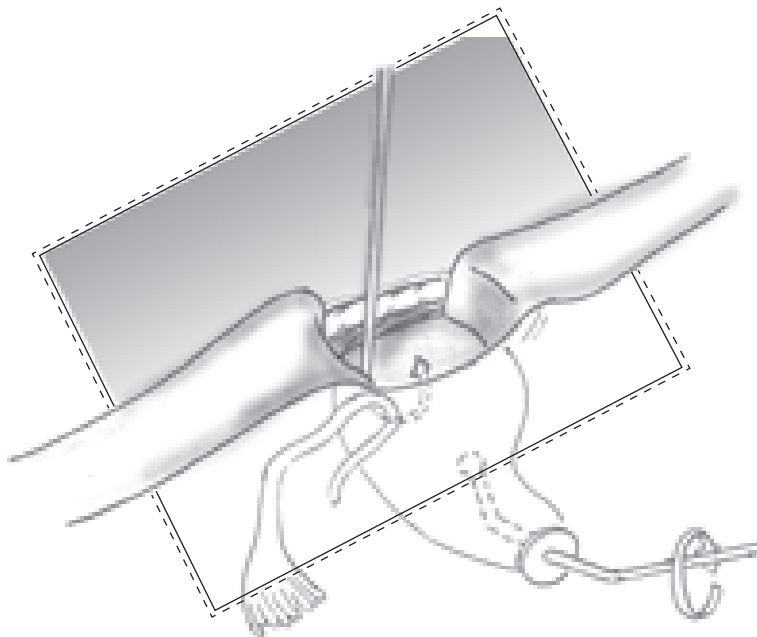
## Entering the abdomen: Opening the peritoneum



## Elevating the uterus



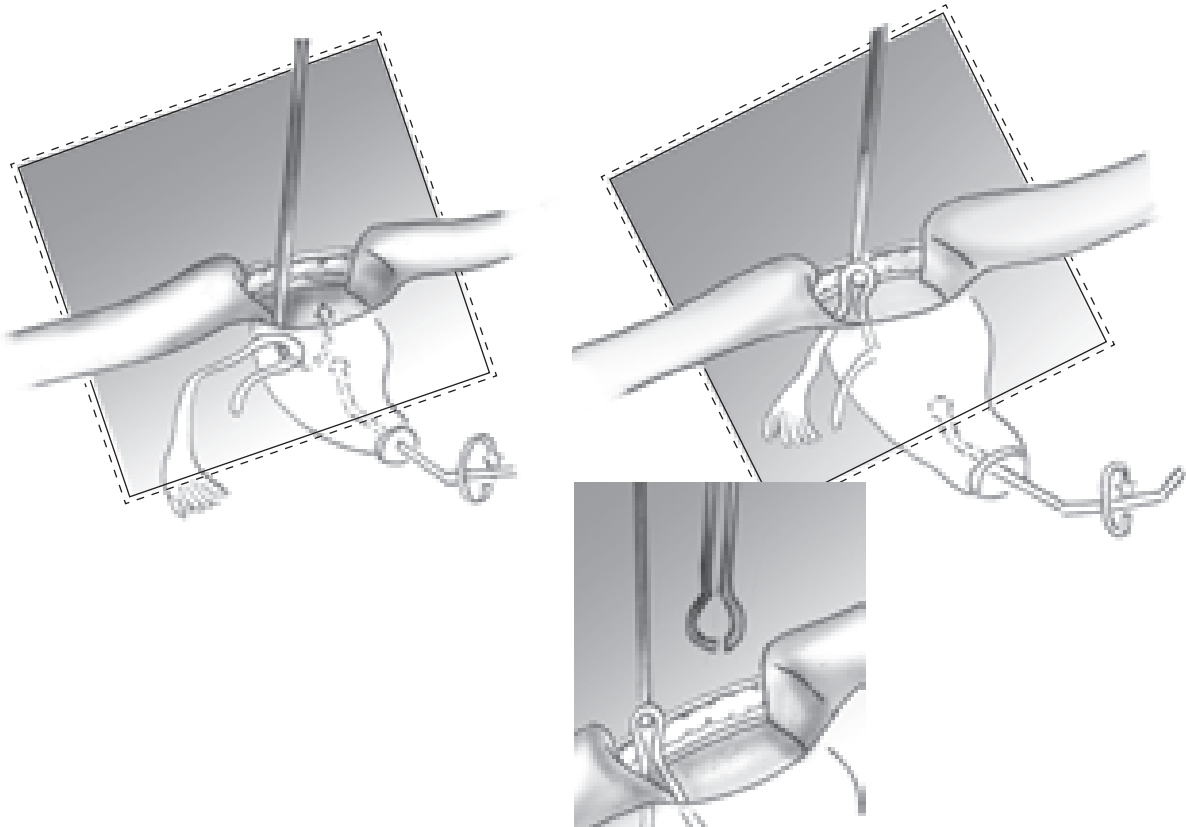
## Using the tubal hook: Bringing the tube to the incision



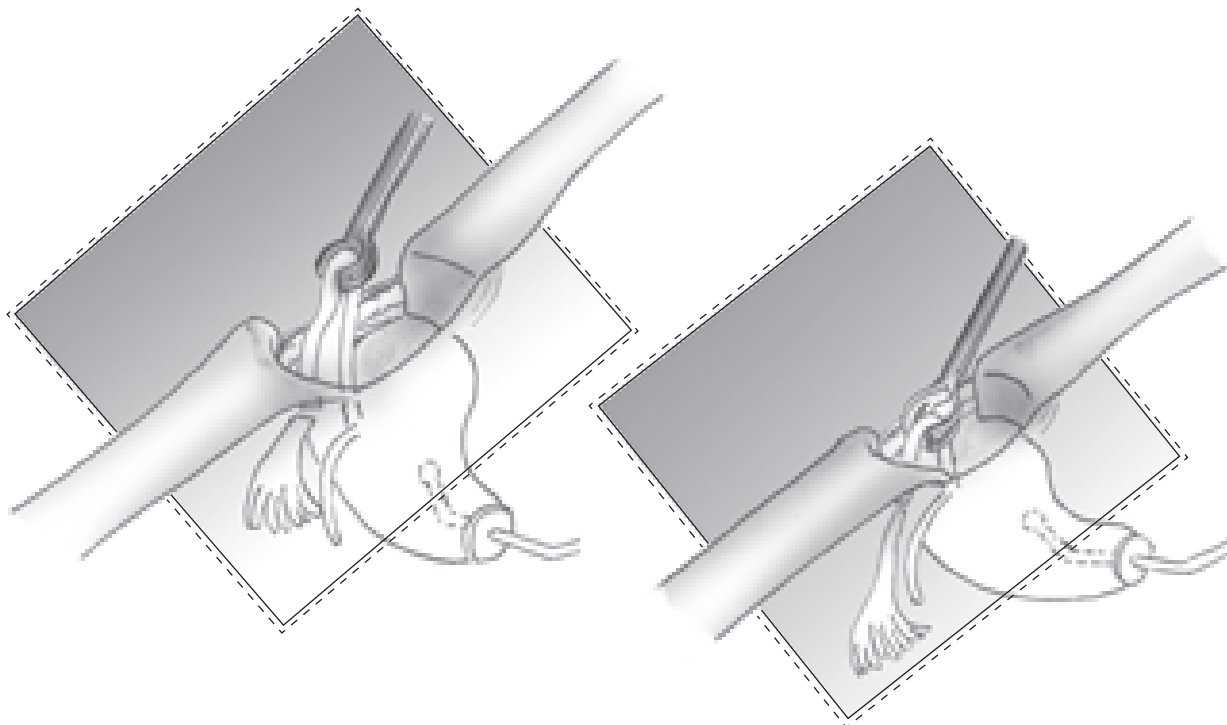
### Using the tubal hook: Bringing the tube to the incision (cont'd)

(c) The tubal hook is pulled horizontally and out through the incision

(d) The fallopian tube is brought to the incision

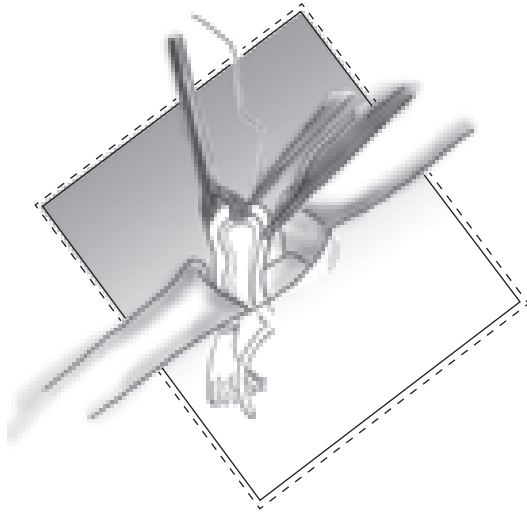


### Confirming the identity of the tube

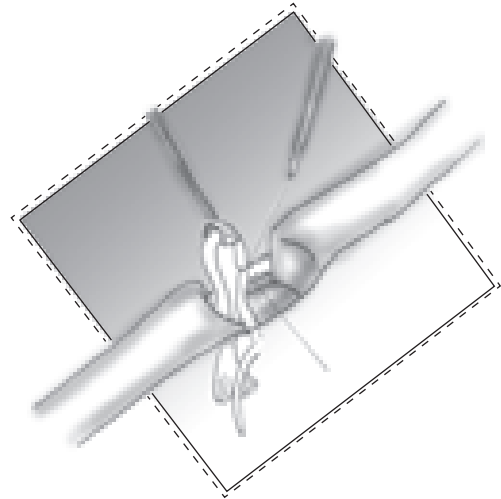


## Steps in the modified Pomeroy technique

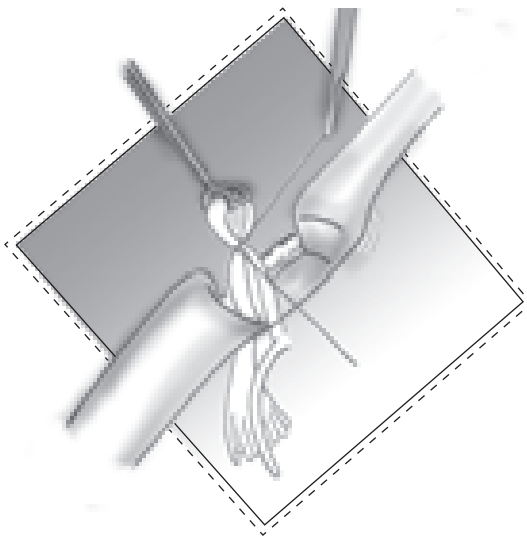
(a) Transfixing



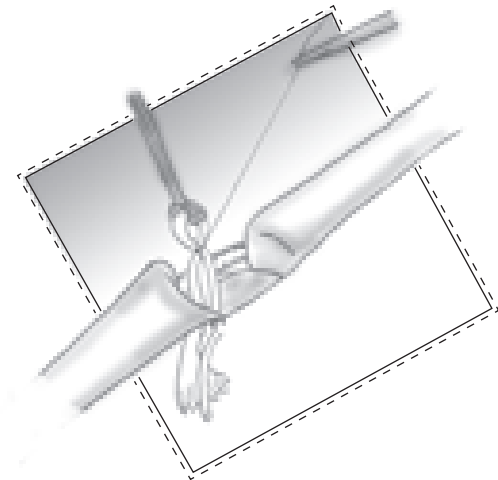
(b) Tying a square knot around the proximal side



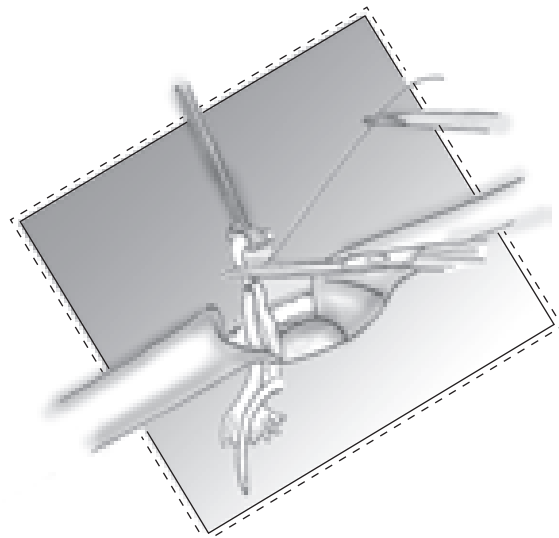
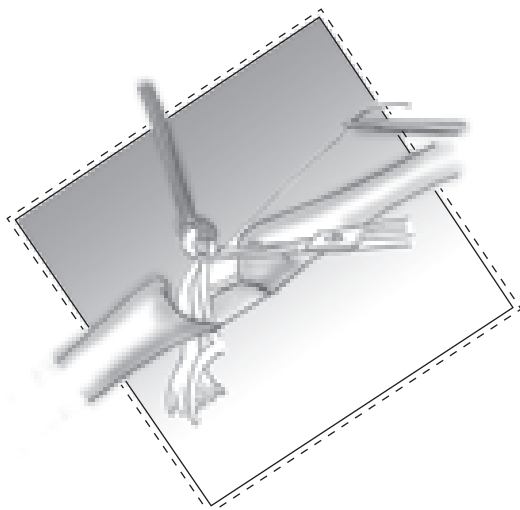
(c) Tying the distal side



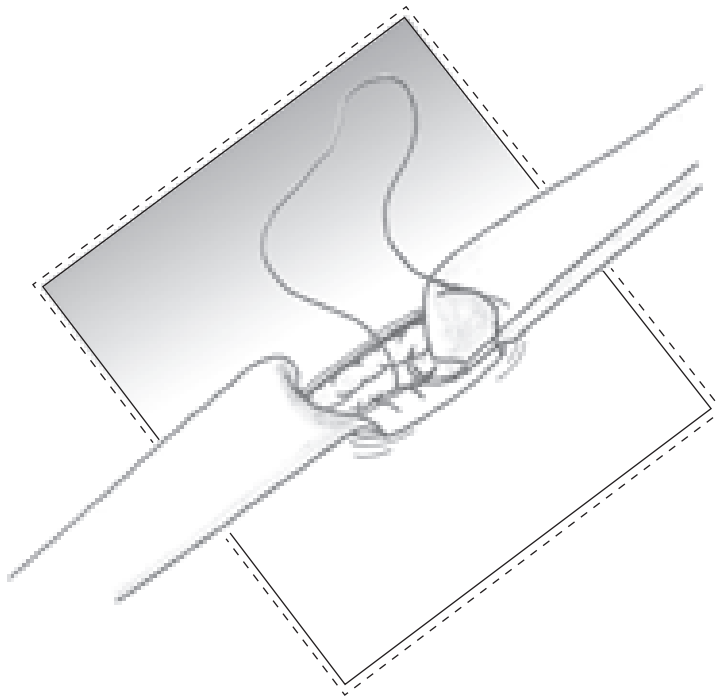
(b) Tying of the loop of the fallopian tube



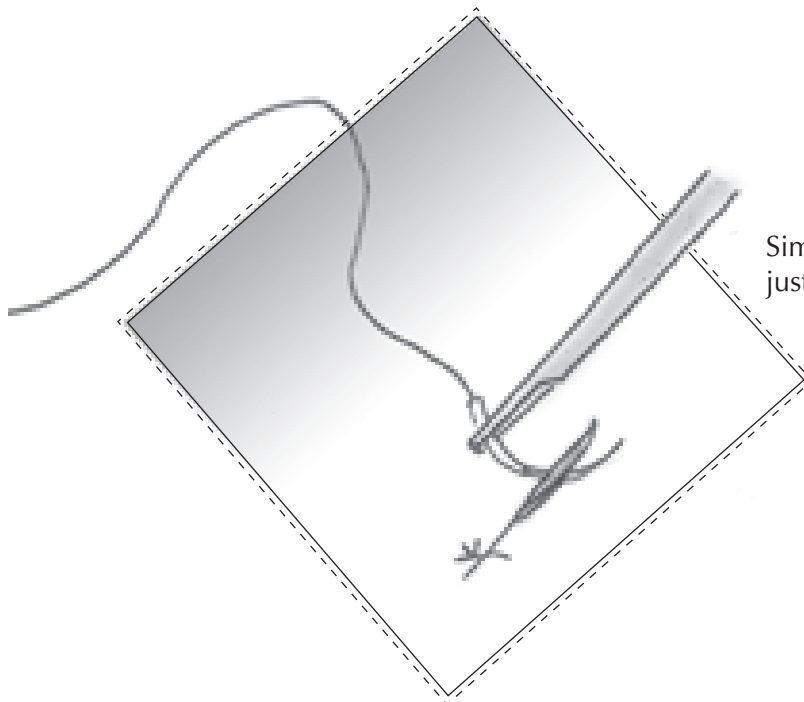
## Cutting the tube



## Closing the fascia

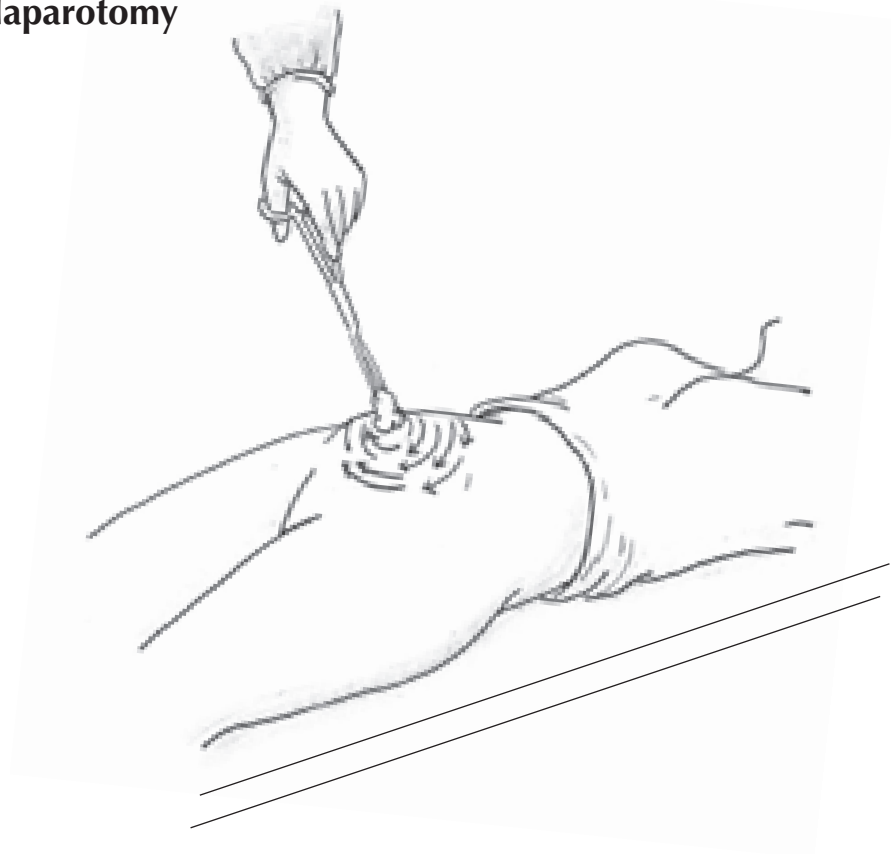


## Confirming the identity of the tube



Simple interrupted stitch  
just to approximate skin

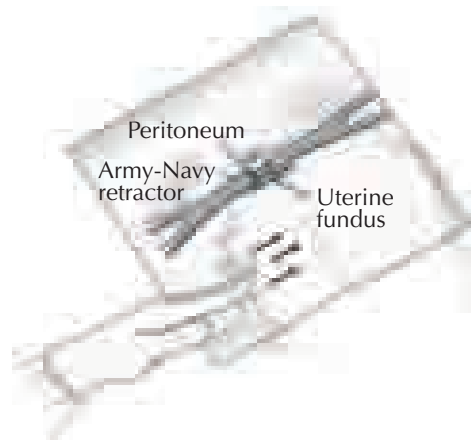
## Preparing the client's abdominal area before a subumbilical minilaparotomy



### Accessing the tubes

(a) Pushing the uterus toward the opposite side of the tube being accessed

(b) Moving the incision to be above the tube being accessed



### **Immediate post operative care:**

- Receive the client from the theatre; review the client record.
- Do not leave a semiconscious or unconscious client unattended.
- Monitor the client's vital signs:
  - Check blood pressure, respiration, and pulse every 15 minutes until the client is stabilized at pre-operative levels.
  - Thereafter, check vital signs every 30 minutes until the client has fully recovered from the effects of anaesthesia.
  - Record these results if used in the client's records.
- For interval cases, check for vaginal bleeding other than menstruation. If there is bleeding, check for injury to the cervix caused by the uterine elevator.
- Check surgical dressing for oozing or bleeding.
- Observe the general condition of the client (including changes in skin colour, post-operative pain, level of consciousness and orientation to time and space).
- Administer drugs or treatment for symptoms as necessary.
- Provide black tea to raise blood sugar levels and stimulate intestinal motility.
- Handle the client gently when moving her.
- Make the client comfortable, according to the climate.
- Complete the client record form.

### **Post operation instructions:**

- Rest for one or two days at home. She will probably be able to resume most of her normal activities within 3 - 5 days.
- Avoid heavy work or lifting for one week. This will help the wound heal.
- Avoid letting the bandage get wet for 1-2 days.
- Take the medicine provided accordingly.
- Have sex as soon as it is comfortable for her. This is usually about one week after the operation.
- Avoid pulling, scratching, or otherwise irritating the site.
- Expect some pain and swelling around the site; it may also be somewhat discoloured (bruised). This is normal and should not worry her.
- Return to the facility if she has any of the following danger signs, or notices unusual body changes:
  - Fever within one week of the operation (over 38.0oC or 100.4oF).
  - Pain in her belly that does not go away or that becomes worse in spite of using painkillers.

- Bleeding or pus oozing from the wound.
- Dizziness with fainting.
- Signs that she may be pregnant - missed period, stomach pains, or dark or spotty bleeding between periods. The client should watch for these signs at any time after the operation. They may mean the operation has failed, and she may be pregnant.
- Persistent or increased abdominal pain.

### **Follow-up visits:**

- First follow-up visit after 7 days to check on the healing of the wound and removal of non-absorbable suture, if was used.
- No routine follow-up except on client's needs.
- A client should also return if she feels she needs protection from STI/HIV/AIDS and is not currently using the dual method.

### **Male No Scalpel Vasectomy**

The section will focus on:

- Definition of NSV
- Mechanism of action
- Characteristics
- Who can use NSV
- Pre operative information
- Overview of eligibility criteria
- Correcting misconceptions and misunderstandings
- Performing NSV
- Post operative instructions

### **Definition**

Vasectomy is very safe, convenient, highly effective, and permanent method of family planning that is achieved by simple surgery done to occlude and divide Vas deference.

### **Mechanism of Action**

Vasectomy prevent pregnancy by creating discontinuity in vas deference, thus sperm cell produced at the level of tests will not be part of the semen/ ejaculate that normally reach the egg and effect fertilization

### **NSV Characteristics**

- Vasectomy is done through small puncture
- Very safe; few restrictions to get vasectomy service



- Vasectomy is highly effective/failure rate of 0.2-.04%/ but not effective in first three month
- There is no adverse long-term effects associated with NSV
- Major morbidity/mortality is rare with NSV, but has minor complication
  - Post operative infection,
  - Bleeding/hematoma formation,
  - Pain occur in 5-10%
- Does not protect against STI,

### **Correcting Misunderstandings about NSV:**

- Does not remove the testicles. In vasectomy the tubes carrying sperm from the testicles are blocked. The testicles remain in place, thus male VSC is NOT a castration.
- Does not decrease sex drive.
- Does not affect sexual function. A man's erection is as hard, it lasts as long, and he ejaculates the same as before.
- Does not cause a man to grow fat or become weak, less masculine, or less productive.
- Does not cause any diseases later in life.

### **Who can use NSV**

With proper **counselling and informed** consent, any man can have a vasectomy safely, including men who:

- Have no children or few children
- Are not married
- Do not have wife's permission
- Are young
- Have sickle cell disease
- Are at high risk of infection with HIV or another STI
- Are infected with HIV, whether or not on antiretroviral therapy

### **Screening Men for Medical Eligibility for VSC**

No medical conditions prevent men from using VSC. However some known medical conditions may limit when, where or how the male VSC procedure should be performed. All conditions are classified in 4 categories

- ACCEPT – means there is no medical reason to deny male VSC to a person with this condition.

- **CAUTION** - means the procedure can be performed in a routine setting but with extra preparation and precautions, depending on the condition.
- **DELAY** - means postpone male VSC. These conditions must be treated and resolved before male VSC can be performed. Give the client another method to use until the procedure can be performed.
- **SPECIAL** - means special arrangements should be made to perform the procedure in a setting with an experienced surgeon and staff, equipment to provide general anaesthesia, and other backup medical support. For these conditions, the capacity to decide on the most appropriate procedure and anaesthesia regimen also is needed. Give the client another method to use until the procedure can be performed.

Providers who **counsel and refer** men for VSC should be aware of the conditions which require procedure to be delayed. Providers who perform male VSC procedure will screen men for all conditions, including those which require caution or special arrangements.

### **For whom we should delay Vasectomy Procedure**

- Local infection
- Previous scrotal injury
- Systemic infection or GE
- Large varicocele
- large hydrocele
- Filariasis ,elephantiasis
- Local pathological condition : mass
- Bleeding disorder, Diabetes

### **VSC for Men With HIV**

- Men who are infected with HIV, have AIDS, or are on antiretroviral (ARV) therapy can safely have a vasectomy. Special arrangements are needed to perform vasectomy on a man with AIDS.
- Vasectomy does not prevent transmission of HIV.
- Urge these men to use condoms in addition to vasectomy. Used consistently and correctly, condoms help prevent transmission of HIV and other STIs.
- No one should be coerced or pressured into getting a vasectomy, and that includes men with HIV/AIDS Cases.

### **Preoperative History and Physical examination, with emphasis on:**

- Reproductive goal and
- Genito-urinary system examination
  - Penile:
    - ◆ Visual inspection.

- ♦ Deep palpation
- ♦ Potential abnormalities.
- Scrotal:
  - ♦ Visual inspection.
  - ♦ Deep palpation
  - ♦ Potential abnormalities

### **Pre-procedure information**

- The procedure make him infertile for life, is permanent and difficult/impossible to reverse
- About the procedure: It is a minor surgical procedure that will be done under local anesthesia over the scrotum
- Need for return to health facility in case of complication, that rarely happens: hemorrhage, swelling, signs of wound infection
- That the procedure is not interfering with both sexual desire and performance
- Lack of contraceptive effectiveness for the first three month after NSV, and the need for using additional reliable contraceptive method during this period
- Lack of protective effect against STI including HIV
- The need for signed informed consent

### **Pre-procedure preparation**

- Preoperative History and Physical examination, with emphasis on:
  - Reproductive goal and
  - Genito-urinary system examination

### **Obtaining Informed Consent**

Informed consent is the client's acceptance, agreement, or permission given under his or her own free will after making an informed decision

7 Elements of Informed consent

1. The understanding that this is a surgical procedure
2. The knowledge of the availability of temporary methods
3. An understanding of the benefits and risks of the procedure, including the small risk of failure
4. The understanding that it is intended to be permanent
5. The understanding that if the VSC is successful, the client will have no more children
6. The understanding that VSC does not protect the client or his/her partner from infection with sexually transmitted infections, including HIV/AIDS
7. Knowledge of the option to decide against the procedure at any time before the operation

## Instruments and supplies needed for no-scalpel vasectomy

### Instruments

- Ringed clamp
- Dissecting forceps
- Straight scissors

### Supplies

- Adhesive tape and gauze for positioning the penis away from the surgical field (optional)
- Scissors for clipping any scrotal hair that would interfere with the procedure
- Soap and water or antiseptic agents for the surgical scrub
- Alcohol rinse (recommended if plain soap is used for the surgical scrub)
- Sterile gloves
- Nonirritating antiseptic solution for cleaning the operative area
- Sterile drapes
- 10-cc syringe with a 1½-inch, 25- or 27-gauge needle (U.S. system)
- 1% or 2% lidocaine without epinephrine
- Supplies for vasal occlusion according to the surgeon's preference (examples: a cautery unit; chromic catgut or nonabsorbable silk or cotton for ligation)
- Sterile gauze
- Adhesive tape or Band-Aid for dressing the wound

### NSV Instruments



Extra cutaneous vas fixation forceps



Vas dissecting forceps

#### Note:

that all procedures and issues related to the surgical procedures itself will be covered in a separate document intended only for clinicians trained in providing Male VSC

## Post Operative Care for No-Scapel Vasectomy

### Provide immediate post operative care:

- Receive the client from theatre and review his record for completeness.
- Monitor and record the client's vital signs.
- Check surgical dressing for oozing or bleeding.
- Manage symptoms if necessary.
- If there are no problems for 30 min. to 1 hour, discharge client.

### Post operative instructions:

- Keep adhesive strapping on for 5 days.
- Avoid pulling or scratching wound while healing.
- Bath after 24 hours but do not to let the wound get wet.
- Remove the bandage after 5 days and wash the site with soap and water.
- Wear a tight underpants/innerwear.
- Take 1 or 2 analgesic tablets every 4 to 6 hours for Pain.
- Avoid heavy lifting, riding a bicycle and hard work for 3 days.
- Avoid sexual intercourse for 2 or 3 days or until comfortable.
- Use condoms or another family planning method for 12 weeks .
- Return for a seminal fluid analysis 12 weeks after the operation (if laboratory facilities are available).
- Return immediately if he notices any of the warning signs, such as:
  - Fever (greater than 38oC or 100.4oF).
  - Bleeding or fluid coming from the incision
  - Painful incision site or scrotum.
  - Enlargement of scrotum.
- Ask client to return:
  - Any time client has a problem/concern.
  - After 7 days post operative to check healing of the site.
- After 12 weeks for seminal analysis.

### Men's Reproductive Health Needs:

This section will highlight and emphasize to Service Providers on the importance of men's other reproductive and health needs. These needs has not been emphasized enough in the past, leading to a misconception that reproductive health is a concern for the women only. However,

of late, the importance of active participation and involvement of men in their own and partner reproductive health services is being recognized as an important component of reproductive health programs requiring a special attention. Addressing male reproductive needs may:

- Make reproductive health services more attractive to men, so they can be a stakeholders and users of reproductive health services.
- Provide an opportunity for men to play an important supportive role to their female partners.
- Make men who use reproductive health services strong advocates of the importance of such services to other men.

## **Why Involve Men?**

Women have traditionally been the focus of family planning programs. Women have often borne all the responsibility for their reproductive health care, whether for the purpose of controlling fertility, protecting against sexually transmitted infections (STIs), or caring for a pregnancy. Today, many factors suggest that these issues are better addressed by women and men.

When men are involved in reproductive health decisions, both men and women are more likely to communicate with each other, make joint decisions about contraceptive use, discuss how many children they would like to have, and be actively involved in child rearing and domestic chores.

Women have suffered as a result of men's absence from reproductive health care. For example, some women have needed to be treated repeatedly for the same STI because their partners do not have access to or will not seek care.

Men often play a critical role in women's reproductive health. Frequently, they decide if and when a couple uses contraception (either to protect against disease or pregnancy), how and when to make resources available to a female partner to help her get care, and whether and when a female partner seeks prenatal care. Men have also been shown to play a key role in deciding whether and when a pregnant woman seeks emergency obstetrical care and by what means of transport she arrives at the health care facility—the factors that have the most direct impact on outcomes for the mother and baby.

## **Involving Men May Benefit the Community**

Offering men reproductive health care services may result in the following important benefits:

- Greater access to high-quality reproductive health services by women and men.
- Higher rates of diagnosis and treatment for STIs.
- Fewer new cases of HIV infection and other STIs
- Early detection and treatment of prostate and testicular cancer
- Fewer adolescent pregnancies
- Better understanding of infertility problems
- Greater male involvement with children and contributions to parenting
- Better understanding of maternity issues, maternity care, and ways to recognize an obstetric emergency

- Better understanding of domestic violence and ways to enhance men’s ability to communicate in non-violent ways, including legal protection for victims
- Better understanding of gender roles, traditional inequities between men and women, and how changing gender roles might benefit everyone
- Better understanding of sexuality and the different ways in which women and men experience sexual pleasure
- More intimate and sexually satisfying relationships between sex partners
- Increased communication between partners regarding reproductive and sexual health concerns
- Improved health overall for women, men, and children

### Men’s Reproductive Health Needs

This section highlights some reproductive health needs topics concerning men. Providers should be aware of these needs as they counsel men and be able to offer either services or referrals:

- Sexuality and sexual dysfunction
  - Concerns about penis size
  - Early ejaculation
  - Impotence
- Prostate and Testicular cancer
- Male circumcision
- HIV risk assessment and prevention counselling
- Infertility and couple counselling

*Note: Screening for particular conditions should be performed only if treatment or referral for treatment is available.*

### The Men’s Reproductive Health Model

#### Part I: Screening for Conditions Which May Require Counselling, Treatment or Referral

Screen	The service provider asks about or checks	If necessary, the service provider offers services or refers the client to another facility
<b>Sexual and reproductive history</b>	<ul style="list-style-type: none"> <li>• Sexual experience and behaviour</li> <li>• Any incidence of sexual abuse or domestic violence</li> <li>• Contraceptive use (especially condoms)</li> <li>• Desires/concerns of fatherhood</li> </ul>	<ul style="list-style-type: none"> <li>• Services for survivors and perpetrators of sexual abuse and domestic violence</li> <li>• Counselling on paternal rights and responsibility, single fatherhood support groups, parenting classes</li> </ul>

<b>Age-appropriate routine physical examination (as required for sports, jobs, etc.)</b>	<ul style="list-style-type: none"> <li>• Blood pressure, lipid profile, heart/lungs</li> <li>• Urine sample and questions about urinary difficulties or concerns (may include dipstick urinalysis and check for nitrites)</li> <li>• Nutrition/diet habits</li> <li>• Development</li> </ul>	<ul style="list-style-type: none"> <li>• Dental care</li> <li>• Vaccinations</li> <li>• Dietary education</li> <li>• Job training, educational programs, employment/counselling services</li> </ul>
<b>Cancer evaluation</b>	<ul style="list-style-type: none"> <li>• Family history of prostate, testicular, colon, skin cancer</li> <li>• Whether the client has ever had a prostate exam, testicular exam, colonoscopy, skin cancer screening</li> </ul>	<ul style="list-style-type: none"> <li>• Follow-up testing and treatment for cancer, as needed</li> </ul>
<b>Substance abuse and mental health needs</b>	<ul style="list-style-type: none"> <li>• Use of such substances as alcohol, tobacco, drugs, steroids</li> <li>• Depression</li> <li>• Difficulty managing anger</li> <li>• Difficulty managing anxiety</li> </ul>	<ul style="list-style-type: none"> <li>• Substance-abuse treatment</li> <li>• Mental health care/stress management</li> <li>• Counselling on violence prevention</li> <li>• Services for runaways/homeless persons</li> </ul>



## The Men's Reproductive Health Model (continued)

### Part 2: Clinical Diagnosis and Treatment

Condition	The service provider delivers services or refers the client to another facility for
<b>Sexual dysfunction and other disorders of the male reproductive system</b>	<ul style="list-style-type: none"> <li>• Erectile dysfunction (impotence)</li> <li>• Premature ejaculation</li> <li>• Disorders of the reproductive system</li> <li>• Hernias</li> <li>• Varicocele</li> <li>• Urological disease (e.g., benign prostate hyperplasia)</li> <li>• Counselling</li> </ul>
<b>Sexually transmitted infections (STIs), including HIV infection</b>	<ul style="list-style-type: none"> <li>• Blood test for HIV infection and other STIs</li> <li>• Urethral swabs (to test for chlamydia and gonorrhoea)</li> <li>• Treatment of STIs, including gonorrhoea, syphilis, chlamydia, HPV, genital warts, and HIV infection/AIDS</li> </ul>
<b>Fertility Problems</b>	<ul style="list-style-type: none"> <li>• History, examination, and semen analysis</li> <li>• Blood test for paternity</li> <li>• Semen analysis</li> <li>• Infertility services</li> <li>• Sperm bank</li> </ul>
<b>Vasectomy</b>	<ul style="list-style-type: none"> <li>• Pre-vasectomy counselling</li> <li>• Vasectomy</li> <li>• Post-vasectomy semen analysis-if laboratory facilities available.</li> </ul>

### Male Circumcision and HIV

Three clinical trials have shown that adult male circumcision is an effective intervention for reducing the risk of HIV infection. The trials conducted in South Africa, Uganda and Kenya demonstrated that circumcision reduces HIV infection among circumcised men by more than 60% when compared to uncircumcised men. Circumcision is known to have additional benefits, such prevention of inflammation of the glans and foreskin, reduced risk of penile cancer, and a lower prevalence of some STIs especially ulcerative diseases like chancroid and syphilis.