



# **THE UNITED REPUBLIC OF TANZANIA**

**MINISTRY OF HEALTH, COMMUNITY DEVELOPMENT,  
GENDER, ELDERLY AND CHILDREN**

## **THE NATIONAL GUIDELINES FOR WATER, SANITATION AND HYGIENE IN HEALTH CARE FACILITIES**

**OCTOBER, 2017**

# TABLE OF CONTENTS

<b>TABLE OF CONTENTS</b> .....	<b>I</b>
<b>LIST OF TABLES</b> .....	<b>VI</b>
<b>LIST OF FIGURES</b> .....	<b>VIII</b>
<b>FOREWORD</b> .....	<b>IX</b>
<b>ACKNOWLEDGEMENTS</b> .....	<b>X</b>
<b>ABBREVIATIONS AND ACRONYMS</b> .....	<b>XI</b>
<b>GLOSSARY</b> .....	<b>XV</b>
<b>CHAPTER ONE</b> .....	<b>1</b>
<b>1.0 INTRODUCTION</b> .....	<b>1</b>
1.1 BACKGROUND .....	1
1.2 SCOPE OF THE GUIDELINES .....	2
1.3 USERS OF THE GUIDELINES .....	2
1.4 RATIONALE FOR DEVELOPING THE GUIDELINES.....	2
1.5 OBJECTIVES OF THE GUIDELINES.....	2
1.6 ORGANIZATION OF THE DOCUMENT.....	3
<b>CHAPTER TWO</b> .....	<b>4</b>
<b>2.0 OVERVIEW OF WASH IN HEALTH CARE FACILITIES</b> .....	<b>4</b>
2.1 WASH IN HEALTH CARE FACILITIES: A GLOBAL PERSPECTIVE .....	4
2.2 GLOBAL INITIATIVES FOR IMPROVED WASH IN HEALTH CARE FACILITIES .....	4
2.3 WHO MINIMUM WASH STANDARDS IN HEALTH CARE FACILITIES.....	5
2.4 OVERVIEW OF WASH IN HEALTH CARE FACILITIES IN TANZANIA .....	5
2.5 STRATEGIES FOR IMPROVING WASH IN HEALTH CARE FACILITIES IN TANZANIA.....	7
<b>CHAPTER THREE</b> .....	<b>8</b>
<b>3.0 LEGAL AND INSTITUTIONAL FRAMEWORK FOR WASH IN HEALTH CARE FACILITIES IN TANZANIA</b> .....	<b>8</b>
3.1 OVERVIEW .....	8
3.2 RELATED SECTORAL NATIONAL POLICIES .....	8
3.2.1 <i>National Health Policy 2007</i> .....	8
3.2.2 <i>National Water Policy 2002</i> .....	9
3.2.3 <i>National Environmental Policy 1997</i> .....	9
3.2.4 <i>Community Development Policy 1996</i> .....	9
3.3 RELATED NATIONAL LEGISLATIONS.....	9
3.3.1 <i>Environmental Management Act, 2004</i> .....	9
3.3.2 <i>The Tanzania Occupational Health and Safety Act, 2003</i> .....	9
3.3.3 <i>Public Health Act, 2009</i> .....	9
3.3.4 <i>The Local Government (District and Urban Authorities) Act, 1982 as amended on 30 June, 2000</i> .....	10
3.3.5 <i>Energy and Water Utilities Regulatory Authority (EWURA) Act, 2001</i> .....	10
3.3.6 <i>Water Supply and Sanitation Act No. 12 (2009)</i> .....	10
3.3.7 <i>Water Resources Management Act, 2009</i> .....	10

3.4	RELATED NATIONAL STRATEGIES .....	10
3.4.1	<i>The National Water Sector Development Strategy 2006-2015</i> .....	10
3.4.2	<i>The National Environmental Health, Hygiene and Sanitation Strategy (NEHHSAS 2008-2017)</i> .....	10
3.5	INSTITUTIONAL FRAMEWORK .....	10
3.5.1	<i>National level</i> .....	10
3.6	REGIONAL AND COUNCIL LEVELS HEALTH MANAGEMENT TEAMS .....	10
3.7	COUNCIL HEALTH SERVICE BOARDS AND HEALTH CARE FACILITY GOVERNING COMMITTEES .....	10
3.8	HEALTH FACILITY MANAGEMENT TEAMS .....	12
<b>CHAPTER FOUR</b> .....		<b>13</b>
<b>4.0</b>	<b>PLANNING AND BUDGETING FOR WASH IN HEALTH CARE FACILITIES</b> .....	<b>13</b>
4.1	INTRODUCTION .....	13
4.2	PLANNING FOR WASH ACTIVITIES IN HEALTH CARE FACILITIES .....	13
4.2.1	<i>Planning Process</i> .....	13
4.3	FUNDS ALLOCATION CRITERIA .....	13
4.4	MAJOR CONSIDERATIONS IN PLANNING AND DESIGNING OF WASH INTERVENTIONS .....	14
4.4.1	<i>WASH plans as integral part of CCHP</i> .....	14
4.4.2	<i>Involvement of community/users</i> .....	15
4.4.3	<i>Strategic partnership with other stakeholders</i> .....	15
4.4.4	<i>Choice of low-cost and quality WASH facilities</i> .....	15
4.4.5	<i>WASH facilities for people with special needs</i> .....	15
4.4.6	<i>Needs for women, girls and children</i> .....	15
4.4.7	<i>Environmental safeguards</i> .....	16
4.4.8	<i>Sustainability plans</i> .....	16
<b>CHAPTER FIVE</b> .....		<b>18</b>
<b>5.0</b>	<b>WATER SUPPLY IN HEALTH CARE FACILITIES</b> .....	<b>17</b>
5.1	WATER NEEDS IN HEALTH CARE FACILITIES .....	17
5.2	WATER SOURCES .....	17
5.2.1	<i>Types of water sources</i> .....	17
5.2.2	<i>Basic considerations in selecting appropriate water sources for HCFs</i> .....	17
5.2.3	<i>Selection of available and feasible options of water sources</i> .....	18
5.3	RECOMMENDED WATER SOURCES FOR EACH FACILITY LEVEL .....	18
5.3.1	<i>Connection to existing water supply systems</i> .....	19
5.3.2	<i>Development of own water sources</i> .....	19
5.3.2.1	Construction of boreholes .....	20
5.3.2.2	Construction of protected shallow wells .....	20
5.3.3	<i>Operation and maintenance of water supply systems</i> .....	21
5.3.4	<i>Taping Springs</i> .....	22
5.3.5	<i>Operation and maintenance of springs</i> .....	23
5.3.6	<i>Installation of rain water harvesting systems</i> .....	24
5.3.6.1	Minimum specifications for RWH systems in health care facilities .....	24
5.3.6.2	O&M for rooftop rainwater harvesting system .....	27
5.4	WATER SOURCES PROTECTION .....	27
5.5	MINIMUM WATER REQUIREMENTS FOR HEALTH CARE FACILITIES .....	28
5.6	WATER STORAGE .....	29
5.6.1	<i>Minimum water storage requirements for HCFs</i> .....	29
5.6.2	<i>Cleaning and disinfection of water storage tanks</i> .....	30
5.7	WATER QUALITY .....	31
5.7.1	<i>Water quality standards for health care facilities</i> .....	31

5.8	WATER TREATMENT .....	32
5.8.1	<i>Disinfection</i> .....	32
5.9	WATER ACCESS AND DISTRIBUTION.....	32
5.9.1	<i>Major considerations in the distribution of water in health care facilities</i> .....	32
<b>CHAPTER SIX .....</b>		<b>33</b>
<b>6.0</b>	<b>SANITATION IN HEALTH CARE FACILITIES .....</b>	<b>33</b>
6.1	INTRODUCTION .....	33
6.2	GENERAL ADEQUACY CRITERIA FOR EXCRETA DISPOSAL FACILITIES IN HEALTH CARE FACILITIES.....	33
6.2.1	<i>User convenience</i> .....	33
6.2.2	<i>Accessibility</i> .....	33
6.2.3	<i>Reliability</i> .....	33
6.2.4	<i>Safety</i> .....	33
6.3	RECOMMENDED PUBLIC TOILET FOR HEALTH CARE FACILITIES.....	34
6.4	DESIGNING AND CONSTRUCTION OF SANITATION FACILITIES .....	35
6.4.1	<i>General considerations</i> .....	35
6.4.2	<i>Flush toilets</i> .....	36
6.4.2.1	Structural components of a flush toilet.....	36
6.4.2.2	Maintenance and hygiene of flush toilets.....	36
6.4.3	<i>Ventilated Improved Pit Latrines</i> .....	37
6.4.3.1	General features of a VIP latrine.....	37
6.4.3.2	Structural components.....	37
6.4.4	<i>Toilet features for people with special needs</i> .....	41
6.4.5	<i>Urinals</i> .....	43
6.4.5.1	Urinals.....	43
6.4.5.2	Major features of a urinal.....	43
6.5	SPECIFIC EXCRETA DISPOSAL REQUIREMENTS FOR DIFFERENT LEVELS OF HEALTH CARE FACILITIES.....	44
6.6	GUIDELINES FOR WASTE AND FAECAL SLUDGE MANAGEMENT .....	47
6.6.1	<i>Importance of proper handling and disposal of wastes</i> .....	47
6.6.2	<i>Acceptable procedures in handling and disposal of wastes</i> .....	47
6.6.2.1	Management of wastewater.....	47
6.6.3	<i>Wastewater treatment systems</i> .....	47
6.6.3.1	Anaerobic treatment system.....	47
6.6.3.2	Decentralized septic tank system .....	48
6.6.3.3	Guidelines for construction of Decentralised system.....	49
6.6.3.4	Pre-treatment of liquid waste .....	49
6.6.4	<i>Management of faecal sludge</i> .....	49
6.6.4.1	Technology for treatment of faecal sludge.....	49
6.6.4.2	Selection criteria for treatment technology .....	50
6.6.5	<i>Management of storm water</i> .....	52
6.6.5.1	General storm-water control requirements.....	52
6.6.5.2	Storm water management for small size health care facilities.....	52
6.6.5.3	Storm water management for large health care facilities.....	53
6.7	OPERATIONS AND MAINTENANCE OF SANITATION FACILITIES .....	53
<b>CHAPTER SEVEN.....</b>		<b>54</b>
<b>7.0</b>	<b>HYGIENE IN HEALTH CARE FACILITIES .....</b>	<b>54</b>
7.1	INTRODUCTION .....	54
7.2	GUIDELINES FOR HAND HYGIENE IN HEALTH CARE FACILITIES .....	54
7.2.1	<i>Awareness on transmission of pathogens by hands</i> .....	54
7.2.2	<i>Hand hygiene practices</i> .....	54

7.2.2.1	Routine hand washing .....	54
7.2.2.2	Proper drying of hands .....	55
7.2.2.3	Paper towels .....	56
7.2.3	<i>Critical moments of hand hygiene in health care facilities</i> .....	56
7.2.3.1	Hand hygiene in patient handling .....	57
7.2.3.2	Other critical moments for hand hygiene .....	57
7.2.4	<i>Antiseptic hand rubbing</i> .....	57
7.2.5	<i>Antiseptic hand washing</i> .....	58
7.2.6	<i>Surgical hand antisepsis</i> .....	58
7.2.6.1	Surgical hand preparation procedures .....	58
7.2.6.2	Steps for surgical hand rub .....	59
7.3	HAND WASHING FACILITIES AND SPECIFICATIONS FOR HEALTH CARE FACILITIES .....	60
7.3.1	<i>Hand washing facilities and specifications</i> .....	60
7.3.2	<i>Surgeon scrub-sinks</i> .....	61
7.3.3	<i>Hand hygiene facility usage and maintenance</i> .....	62
7.4	GUIDELINES FOR BATHROOM HYGIENE .....	63
7.5	GUIDELINE FOR LAUNDRY HYGIENE .....	63
7.5.1	<i>Safe handling of laundry</i> .....	63
7.5.2	<i>Basic principles in handling linen</i> .....	64
7.5.3	<i>Operation and maintenance of a laundry facility</i> .....	65
7.5.4	<i>Guidelines for kitchen hygiene</i> .....	65
7.6	GUIDELINES FOR MORTUARY HYGIENE .....	65
7.6.1	<i>General cleaning</i> .....	65
7.6.2	<i>Cleaning and disinfection of essential post-mortem/autopsy equipment</i> .....	66
7.7	OTHER ESSENTIAL ASPECTS IN MAINTAINING MORTUARY HYGIENE .....	66
7.8	PROMOTION OF HYGIENE PRACTICES IN HEALTH CARE FACILITIES .....	67
7.9	APPROACHES FOR PROMOTION OF HYGIENE PRACTICES IN HEALTH CARE FACILITIES .....	67
7.10	SUSTAINING HYGIENE PRACTICES IN HCF .....	67
<b>CHAPTER EIGHT .....</b>		<b>69</b>
<b>8.0</b>	<b>WASH SERVICES IN HEALTH CARE FACILITIES DURING EMERGENCY .....</b>	<b>69</b>
8.1	RATIONALE OF WASH IN HEALTH CARE FACILITIES DURING EMERGENCIES .....	69
8.2	PREPAREDNESS AND RESPONSE PLANNING .....	69
8.3	CONDUCTING RAPID ASSESSMENT OF WASH .....	69
8.4	RECOMMENDED GUIDELINES FOR WASH IN HCFs DURING EMERGENCIES .....	70
8.4.1	<i>Priority response actions</i> .....	70
8.4.2	<i>Water supply</i> .....	70
8.4.3	<i>Personal Protective Equipment (PPE)</i> .....	72
8.5	ESTABLISHING OF OPERATIONAL MONITORING SYSTEM .....	72
<b>CHAPTER NINE .....</b>		<b>73</b>
<b>9.0</b>	<b>LANDSCAPING AND VECTOR/VERMIN CONTROL .....</b>	<b>73</b>
9.1	LANDSCAPING, GARDENING AND OUTDOOR SPACES .....	73
9.2	BASIC CONSIDERATIONS IN PLANNING FOR OUTDOOR ENVIRONMENT OF HEALTH CARE FACILITIES .....	73
9.3	OPERATIONAL AND MAINTENANCE .....	74
9.4	VECTOR AND VERMIN CONTROL .....	74

<b>CHAPTER TEN</b> .....	<b>77</b>
<b>10.0 MONITORING OF WASH IN HEALTH CARE FACILITIES</b> .....	<b>77</b>
10.1 INTRODUCTION .....	77
10.2 WHY MONITORING OF WASH SERVICES IN HEALTH CARE FACILITIES- .....	77
10.3 WHAT TO MONITOR? .....	77
10.4 WHO MONITORS AND WHEN? .....	77
10.5 REPORTING .....	79
10.5.1 Ward level .....	79
10.5.2 Council level.....	79
10.5.3 Regional level.....	79
<b>REFERENCES</b> .....	<b>80</b>
<b>ANNEXES</b> .....	<b>84</b>
<b>ANNEX 1: RECOMMENDED NUMBER OF HAND WASHING FACILITIES PER LEVEL OF FACILITY AND LOCATIONS</b> .....	<b>84</b>
<b>ANNEX 2: HAND WASHING BASIN PROVISION FOR SPECIALIZED/ CONSULTANT HOSPITALS</b> .....	<b>86</b>
<b>ANNEX 3: REQUIREMENTS AND SPECIFICATIONS OF BATHROOMS</b> .....	<b>87</b>
<b>ANNEX 4: TEMPLATE FOR RAPID ASSESSMENT OF WASH IN HCFS IN EMERGENCIES</b> .....	<b>90</b>

## LIST OF TABLES

TABLE 2.1: CHANGE OBJECTIVES FOR GLOBAL ACTION PLAN .....	4
TABLE 2.2: HCFs IN TANZANIA MAINLAND BY LEVEL AND TYPE OF OWNERSHIP .....	6
TABLE 2.3: GAPS IN WASH SERVICES IN SELECTED HEALTH CARE FACILITIES.....	7
TABLE 5.1: RECOMMENDED WATER SOURCES PER HEALTH CARE FACILITIES LEVEL.....	19
TABLE 5.2: ROUTINE MAINTENANCE OF SPRINGS .....	24
TABLE 5.3: MAIN ACTIVITIES INVOLVED AND FREQUENCY OF MAINTENANCE OF A RWH SYSTEM.....	27
TABLE 5.4: WATER SOURCE PROTECTION .....	28
TABLE 5.5: NATIONAL WATER REQUIREMENTS FOR HEALTH CARE FACILITIES .....	29
TABLE 5.6: WATER REQUIREMENTS FOR PATIENTS AND VISITORS IN HEALTH CARE FACILITIES.....	29
TABLE 5.7: WATER REQUIREMENTS FOR STAFF IN HEALTH CARE FACILITIES.....	29
TABLE 5.8: WATER STORAGE REQUIREMENTS FOR PATIENTS AND STAFF IN HEALTH CARE FACILITIES .....	30
TABLE 5.9: WATER QUALITY STANDARDS FOR HEALTH CARE FACILITIES.....	31
TABLE 6.1: RECOMMENDED EXCRETA DISPOSAL OPTIONS FOR HEALTH CARE FACILITIES .....	44
TABLE 6.2: PRE-TREATMENT OF LIQUID WASTE .....	49
TABLE 6.3: SLUDGE TREATMENT OPTIONS IN HEALTH CARE FACILITIES .....	50
TABLE 6.4: CRITERIA FOR SELECTION OF FAECAL SLUDGE TREATMENT OPTIONS .....	51
TABLE 7.1: SPECIFICATION OF HAND WASHING FACILITIES IN HEALTH CARE FACILITIES .....	60
TABLE 7.2: OTHER CRITICAL ASPECTS IN MAINTAINING MORTUARY HYGIENE.....	66
TABLE 7.3: TEMPLATE FOR O & M SCHEDULE FOR HYGIENE PRACTICES IN HEALTH CARE FACILITIES .....	68
TABLE 8.1: RECOMMENDED MINIMUM WATER QUANTITIES FOR HCFs IN EMERGENCIES .....	70
TABLE 8.2: ESSENTIAL EMERGENCY CONTROL MEASURES IN HEALTH CARE FACILITIES .....	71
TABLE 9.1: VECTOR /VERMIN CONTROL MEASURES .....	75
TABLE 10.1: ACTORS INVOLVED IN MONITORING OF WASH IN HCFs .....	78

## LIST OF FIGURES

FIGURE 5.1: PROTECTED WATER WELL AT HEALTH CENTRE .....	21
FIGURE 5.2: CROSS-SECTION PARTS OF A SHALLOW WELL .....	21
FIGURE 5.3: ROUTINE MAINTENANCE OF A PROTECTED SHALLOW WELL FITTED IN HAND PUMP .....	22
FIGURE 5.4: RAIN WATER HARVESTING WITH FIRST -FLUSH TANK .....	25
FIGURE 5.5: WATER ABSTRACTION POINT AT A DISPENSARY.....	26
FIGURE 5.6: A SKETCH OF WATER STORAGE.....	30
FIGURE 6.1: TYPES OF TOILETS RECOMMENDED IN HEALTH CARE FACILITIES.....	34
FIGURE 6.2: A CROSS-SECTION PART OF A VIP LATRINE .....	38
FIGURE 6.3: A CROSS- SECTION PART OF SINGLE VIP LATRINE .....	39
FIGURE 6.4: A CROSS- SECTION PART OF A DOUBLE VIP LATRINE.....	40
FIGURE 6.5: DESIGNS OF SANITATION FACILITIES FOR PEOPLE WITH SPECIAL NEEDS.....	41
FIGURE 6.6: TYPES OF RAMPS FOR DISABLED PERSONS.....	42
FIGURE 6.7: TYPES OF URINALS.....	43
FIGURE 6.8: EXAMPLE OF ANAEROBIC TREATMENT SYSTEM .....	48
FIGURE 6.9: A CROSS SECTION OF A SEPTIC TANK .....	48
FIGURE 6.10: PHOTO- TYPE TECHNOLOGY SECTION SCHEME .....	51
FIGURE 6.11: A TYPICAL EXAMPLE OF DOWN SPOUT INFILTRATION .....	52
FIGURE 7.1: STEPS FOR ROUTINE HAND WASHING .....	55
FIGURE 7.2: CRITICAL MOMENTS OF HAND HYGIENE IN HEALTH CARE FACILITIES.....	56
FIGURE 7.3:STEPS FOR HAND RUB.....	57
FIGURE 7.4: STEPS FOR SURGICAL HAND RUB.....	59
FIGURE 7.5: HAND WASHING FACILITY .....	60
FIGURE 7.6: TYPES OF SURGICAL SCRUB SINKS.....	61
FIGURE 7.7: PHOTO- TYPE OF SURGICAL SCRUB SINK .....	62
FIGURE 7.8: SHOWING LAUNDRY HAMPERS .....	64
FIGURE 9.2: EXAMPLES OF LANDSCAPING AND GARDENING IN HEALTH CARE FACILITIES .....	74



## FOREWORD

The provision of improved water, sanitation and hygiene (WASH) services in health care facilities (HCFs) has of late attracted the attention of governments, Development Partners (DPs) and the international public health institutions. This is due to the fact that, although HCFs provide essential medical care to the sick, most of them especially in developing countries lack basic WASH services and thus compromising their ability to provide quality health care and consequently posing serious health risks not only to people who seek treatment but also to health care workers (HCWs) and carers.

There are numerous consequences of poor WASH services in HCFs. Several studies have revealed that, due to inadequate provision of WASH services, patients are potentially at higher risk of developing health care associated infections (HCAIs). The risk of infection is particularly high in newborns leading to sepsis which in most cases is fatal. The risks associated with sepsis are reported to be 34 times greater in developing countries. Further, lack of adequate WASH services may discourage women from giving birth in HCFs or causing delays in care-seeking. Therefore, addressing the inadequate provision of WASH services in HCFs will not only improve the quality of care but also attract many people to seek care including delivery services to pregnant women and most importantly contribute in the prevention of HCAIs.

The Ministry, being the custodian of delivering health care services, acknowledges that at present there are many ongoing initiatives by the government, DPs and private agencies in Tanzania Mainland to improve WASH services in HCFs. However, we have had no uniform and nationally well-organized guidelines to support and guide these initiatives. These guidelines are therefore, intended to provide a standard approach to guide stakeholders in addressing WASH challenges in HCFs countrywide.

Overall, these guidelines have put in place a uniform and harmonized approach in the provision of WASH services in public and private HCFs all over the country. Specifically, they offer practical guidance for planning and budgeting as well as technical designing and construction of recommended WASH facilities, operation and maintenance (O&M), and monitoring of the performance of the services. Furthermore, adherence to these guidelines will provide a safer working environment for HCWs thus improving their performance.

**Dr. Mpoki M. Ulisubisya**

**Permanent Secretary**

## ACKNOWLEDGEMENTS

The process of developing these guidelines has been very involving and therefore needed people with an esteemed knowledge base and experience on WASH. The Ministry would like to appreciate the efforts of all those who participated in every step of developing these important Guidelines which not only will help to improve the quality of health care services but also make the working environment conducive for service providers, patients and carers.

Distinctively, the Ministry wishes to acknowledge Dr. Neema Rusibamayila and Dr. Khalid Massa, the Director for Preventive Services and Acting Assistant Director for Environmental Health and Sanitation Services respectively, for their leadership and moral support in ensuring these guidelines are developed and disseminated to the stakeholders for use.

A special word of thanks goes to Mr. Stephen Kiberiti, Mr. Anyitike Mwakitalima and Ms. Salvata Silayo from the MoHCDGEC for leading the technical team that worked tirelessly to produce these guidelines. Their efforts are valued and will be honoured throughout the course of using this document. Further, the Ministry sincerely commends the great job availed by a team of technical personnel who participated extensively in the preparation of these guidelines. These are; Dr. Sarah Maongezi, Mr. Honest Anicetus, Dr. Mahewa Lusinde, Mr. Adrian Irongo and Ms. Harieth Ringia (MoHCDGEC); Ms. Joseline Ishengoma (PORALG); Eng. Veronica Jenge (MoWI); Dr. Telemu Kassile (SUA); Dr. Gloria Sakwari (MUHAS); Mr. Sibomana Leonard (ARU); Mr. Selemani Yondu (Bahi DC), Mr. Laban Wamala (Kagemu School of Environmental Health), Ms. Lilian Wilfred (School of Nursing-KCMC), Ms. Jennifer Mbise (School of Environmental Health, Tanga), Mr. Ally Kebby (HPSS, Dodoma), Ms. Esther Nhang'ano (Ilala MC), Ms. Prisca Gallet (Morogoro MC), Mr. Philemon Msangi (Mpwapwa School of Environmental Health), Mr. Sanga Ulanziyumile (Tabora RS) and Mr. Twaha Mubarak (WaterAid) . Others are Dr. George Ruhago (Ilala MC), Mr. Silvanus F. Shirima (Ilala MC), Ms. Linda Chatila (Iringa PHCI), Ms. Thea Bongertman (MKAJI), Mr. Rashid Mbago (MG Graphics), Mr. Amri Ugumba (Morogoro MC) and Mr. Deo Binamungu (Achrid Consult).

Furthermore, the Ministry wishes to extend its gratitude to UNICEF and WaterAid Tanzania for their support that facilitated the preparation of these guidelines. It is our hope that, these and other stakeholders will continue working with the government to accelerate the implementation of WASH activities in the HCFs in the country. Finally, a special word of thanks goes to all those who in one way or another contributed to a successful preparation of these guidelines. Their moral, technical and or material support is highly appreciated.

**Prof. Muhammad Bakari Kambi**

**Chief Medical Officer**

## ABBREVIATIONS AND ACRONYMS

ABR	-	Anaerobic Baffled Reactor
AIDS	-	Acquired Immunodeficiency Syndrome
AJWSR	-	Annual Joint Water Sector Reviews
BOD	-	Biological Oxygen Demand
CBOs	-	Community-Based Organizations
CCHP	-	Comprehensive Council Health Plan
CDG	-	Capital Development Grant
CHF	-	Community Health Fund
CHMTs	-	Council Health Management Teams
CHSBs	-	Council Health Services Boards
CORPs	-	Community Own Resource Persons
COs	-	Change Objectives
COWSOs	-	Community Owned Water Supply Organisations
CTC	-	Cholera Treatment Centre
D by D	-	Decentralization by Devolution
DDHs	-	District Designated Hospitals
DHOs	-	District Health Officers
DHS	-	District Health Secretary
DMOs	-	District Medical Officers
DNOs	-	District Nursing Officers
DPs	-	Development Partners
DWE	-	District Water Engineer
EHOs	-	Environmental Health Officers
EWURA	-	Energy and Water Utilities Regulatory Authority
FBOs	-	Faith-Based Organisations
FFD	-	Foul Flush Device
FFS	-	First Flush System
GLAAS	-	Global Analysis and Assessment of Sanitation and Drinking-Water
GoT	-	Government of Tanzania
HBV	-	Hepatitis B Virus

HCAIs	-	Health Care Associated Infections
HCFs	-	Health Care Facilities
HCFGC	-	Health Care Facility Governing Committee
HCV	-	Hepatitis C Virus
HCWM	-	Health Care Waste Management
HCWs	-	Health Care Workers
HDPE	-	High Density Polyethylene
HIV	-	Human Immunodeficiency Virus
HMT	-	Hospital Management Team
HPSS	-	Health Promotion and Systems Strengthening
HRT	-	Hydraulic Retention Time
HSBF	-	Health Sector Basket Fund
ICF	-	Inner City Fund
IPC	-	Infection Prevention and Control
IPD	-	Inpatient Department
JKCI	-	Jakaya Kikwete Cardiac Institute
JMP	-	Joint Monitoring Programme
KCMC	-	Kilimanjaro Christian Medical Centre
LGAs	-	Local Government Authorities
LGRP	-	Local Government Reform Programme
mg/L	-	miligram/litre
MHM	-	Menstrual Hygiene Management
MKAJI	-	Maji kwa Afya ya Jamii
MNH	-	Muhimbili National Hospital
MoEST	-	Ministry of Education, Science and Technology
MoHCDGEC	-	Ministry of Health, Community Development, Gender, Elderly and Children
MoHSW	-	Ministry of Health and Social Welfare
MoHZ	-	Ministry of Health Zanzibar
MOI	-	Muhimbili Orthopedic Institute
MoWI	-	Ministry of Water and Irrigation

MoWLD	-	Ministry of Water and Livestock Development
MTUHA	-	Mfumo wa Taarifa za Uendeshaji Huduma za Afya
MUHAS	-	Muhimbili University of Health and Allied Sciences
NAWAPO	-	National Water Policy
NBS	-	National Bureau of Statistics
NDV	-	National Development Vision
NEHHSAS	-	National Environmental Health, Hygiene and Sanitation Strategy
NGOs	-	Non Governmental Organizations
NIMR	-	National Institute of Medical Research
NSC	-	National Sanitation Campaign
NSHTC	-	National Sanitation and Hygiene Technical Committee
NSMIS	-	National Sanitation Management Information System
NTU	-	Nephelometric Turbidity Units
O&M	-	Operation and Maintenance
OCGS	-	Office of Chief Government Statistician
ODF	-	Open Defecation Free
OPD	-	Outpatient Department
PO-RALG	-	President Office-Regional Administration and Local Government
PPE	-	Personal Protective Equipment
RAT	-	Rapid Assessment Tool
RCH	-	Reproductive and Child Health
RHMTs	-	Regional Health Management Teams
RHOs	-	Regional Health Officers
RMOs	-	Regional Medical Officers
RRHS	-	Rooftop Rainwater Harvesting System
RS	-	Regional Secretariat
RWE	-	Regional Water Engineer
RWH	-	Rain Water Harvesting
SDC	-	Swiss Development Corporation
SOPs	-	Standard Operating Procedures
SUA	-	Sokoine University of Agriculture

SWAp	-	Sector-Wide Approach to Planning
TSPA	-	Tanzania Service Provision Assessment
UASB	-	Upflow Anaerobic Sludge Blanket
UN	-	United Nations
UNICEF	-	United Nations Children's Fund
UWSSAs	-	Urban Water Supply and Sanitation Authorities
VHWs	-	Village Health Workers
VIP	-	Ventilated Improved Pit Latrine
VPO	-	Vice President's Office
WC	-	Water Closet
WASH	-	Water, Sanitation and Hygiene
WATSAN	-	Water and Sanitation
WBOs	-	Water Basin Offices
WEHOs	-	Ward Environmental Health Officers
WEOs	-	Ward Executive Officers
WHO	-	World Health Organization
WSDP	-	Water Sector Development Programme
WUI	-	Water Use Intensity

## GLOSSARY

<b>Adequate water supply</b>	Sufficient quantity of suitable quality water that is physically, legally, and continuously available to satisfy the water demands of health care facilities (HCFs).
<b>Alcohol-based hand rub</b>	An alcohol-based preparation (liquid, gel or foam) designed for application to the hands to inactivate microorganisms and/or temporarily suppress their growth.
<b>Antimicrobial (medicated) soap</b>	Soap (detergent) containing an antiseptic agent at a concentration sufficient to inactivate microorganisms and/or temporarily suppress their growth.
<b>Antiseptic hand rubbing</b>	Applying an antiseptic hand rub to reduce or inhibit the growth of microorganisms without the need for an exogenous source of water and requiring no rinsing or drying with towels or other devices.
<b>Antiseptic hand washing</b>	Remove or destroy transient microorganisms and reduce resident flora using water and antimicrobial soap.
<b>Aquifer</b>	A body of permeable rock able to hold or transmit water
<b>Black water</b>	Wastewater containing faecal matter and urine.
<b>Carer(s)</b>	Refer to family, friends, or voluntary workers who accompany patients to a HCF and provide basic, non-professional care. Carer (s) may be occasional visitors, or they may stay to prepare food, clean and care for patients in a HCF
<b>Changing room</b>	A room within HCFs where health care workers dress in protective clothing and dispose of soiled and contaminated protective clothing.
<b>Detergent (surfactant)</b>	Compounds that possess a cleaning action. They are composed of a hydrophilic and lipophilic part and can be divided into four groups: anionic, cationic, amphoteric and non-ionic.
<b>Disinfection</b>	A process of removing or inactivating microorganisms
<b>Drinking water</b>	Water with acceptable quality complying with national standards used specifically for drinking.
<b>Emergency</b>	Sudden, unexpected, or impending situation that may cause injury, loss of life, or damage which therefore requires immediate assistance or relief.
<b>Emerging diseases</b>	Are the one that have appeared in a population for the first time, or that may have existed previously but are rapidly increasing in incidence or geographic range.
<b>Re-emerging diseases</b>	Are diseases that once were major health problems globally or in a particular country, and then declined dramatically, but are again becoming health problems for a significant proportion of the population.
<b>Environmental surface</b>	Floors, walls, ceiling, table tops etc.
<b>Flush toilet</b>	Also known as a lavatory or water closet (W.C.) is the toilet that disposes human excreta (faeces and urine) by using water to flush it through a drainpipe to another location for disposal.
<b>Gardening</b>	Refers to growing of plants, flowers and grass within the premises of the HCF with a goal of creating a beautiful environment within the landscape
<b>Grey water</b>	All wastewater generated in households or office buildings mainly from cleaning activities such as laundry, showers, dishwashing, floor cleaning and bathing.

<b>Hand washing facility</b>	A facility characterized with running water and soap and mainly used for hand washing.
<b>Hand washing</b>	Washing hands with plain or antimicrobial soap and water.
<b>Hazard</b>	Any source of potential damage or harm or adverse health effect on something or someone.
<b>Health Standards</b>	Clear and verifiable requirements that must be met to achieve minimum essential environmental health conditions in health care facilities.
<b>Health care associated infections</b>	An infection occurring in a patient during the process of care in a health care facility, which was not present or incubating at the time of admission. Health care-associated infections can also appear after discharge
<b>Health Care Waste</b>	A by-product of health care services that include all waste, hazardous or not, generated in the process of performing medical activities.
<b>Hygiene</b>	Conditions and practices that help to maintain health and prevent the spread of diseases
<b>Improved latrine</b>	A sanitation facility, which ensures hygienic separation of human excreta from human contact.
<b>Improved sanitation facilities</b>	Those facilities likely to ensure hygienic separation of human excreta from human contact. They include; flush/pour flush (to piped sewer system, septic tank and pit latrine); ventilated improved pit latrine (VIP); pit latrine with slab and composting toilet.
<b>Improved water source</b>	A water source that by its nature of construction adequately protects the source from outside contamination, particularly faecal matter.
<b>Landscaping</b>	Refers to making land within the HCFs more visibly attractive by altering the existing design, adding ornamental features including planting trees.
<b>Operation and Maintenance</b>	Refers to all post-construction activities needed to operate and maintain and manage a water supply and sanitation system, which goes beyond the technical definition but includes also managerial aspects to run Water, Sanitation and Hygiene (WASH) infrastructures on a sustainable basis.
<b>pH</b>	A measure of acidity and alkalinity of a solution that is a number on a scale on which a value of 7 represents neutrality and lower numbers indicate increasing acidity and higher numbers increasing alkalinity.
<b>Plain soap</b>	Detergents that contain no added antimicrobial agents.
<b>Privacy</b>	Ability of the sanitation facility to provide: protection from disturbance and being observed; shelter against the rain and sunrays; and security to the user.
<b>Rehabilitation</b>	Entails the correction of major defects and the replacement of equipment to enable the WASH facilities to function as originally intended.
<b>Resident time</b>	Refers to average time water is supposed to stay within the tank to avoid deterioration
<b>Residual chlorine</b>	Amount of chlorine that remains in the water after a certain period or contact time.
<b>Runoff coefficient</b>	A dimensionless coefficient relating the amount of runoff to the amount of precipitation received.
<b>Sanitation</b>	Refers to the provision of facilities and services for the safe management of human excreta (urine and faeces).
<b>Sedimentation</b>	The act or process of depositing sediment from suspension in water. The term also refers to the process whereby solids settle out of wastewater by gravity during treatment.



<b>Shallow wells</b>	Refer to wells of shallow depth, generally with a minimum of 30m deep and are often hand dug. Many shallow wells are not perennial as they dry up during extended drought periods.
<b>Soak away pit or soak pit</b>	A simple excavation in the ground either lined or filled with stones, which allow water to percolate into the surrounding soil.
<b>Sterilization</b>	The use of physical or chemical procedure to destroy all microbial life. The most practical method in health-care settings is saturated steam sterilization.
<b>Surgical hand antisepsis</b>	Antiseptic hand wash performed preoperatively by surgical personnel to eliminate transient and reduce resident hand flora.
<b>Turbidity</b>	Cloudiness in water caused by particles in suspension, which makes chemical disinfection of the water less effective. Turbidity is common measure in nephelometric turbidity units (NTU) and can be determined visually using simple equipment.
<b>Visibly soiled hands</b>	Hands showing visible dirt or visibly contaminated with proteinaceous material, blood, or other body fluids (e.g. fecal material or urine).
<b>Water availability</b>	Sufficient and reliable quantities of quality water supplied throughout to meet all uses in HCFs.
<b>Water storage tank</b>	A container with specifications for storage of water for use.
<b>Water supply</b>	Refers to the provision of water by urban or rural utilities usually via a system of pumps and pipes.
<b>Water treatment</b>	Any process that makes water more acceptable for a specific end use. The end uses are both to meet demand for medical and non-medical use in HCFs.



## CHAPTER ONE

### 1.0 INTRODUCTION

#### 1.1 Background

This document contains the national guidelines on water supply, sanitation and hygiene (WASH) services for health care facilities (HCFs) in Tanzania. HCFs play a pivotal role of not only caring for the sick but also in preventing the spread of HCAs, improving health, life expectancy, gender equality, and upholding the dignity of vulnerable populations including pregnant women, children under five years of age and the disabled. HCFs are hence required to have a standardized approach that guides the provision of WASH services so as to ensure quality and safe care and most importantly minimize the risk of HCAs for staff, patients, carers and visitors.

Therefore, adequate WASH services in HCFs and particularly safe hygiene practices such as hand washing by health caregivers, patients and visitors are critical elements for the delivery of quality and safe health care services and can greatly reduce the risk of HCAs, tackle anti-microbial resistance and ultimately improve the health outcomes of patients. In addition maintaining high standards of environmental cleanliness within the premises of HCFs have positive effects on the health of the clients who seek health care services and those who provide services.

The consequences of poor WASH in HCFs are numerous as several studies have revealed. With poor WASH services, HCFs are subject to becoming potential areas of spreading infectious diseases as well as compromising their ability to provide safe and quality health care, thus presenting serious health risks to people who seek health care services and those who provide such services. Global estimates of the burden of endemic HCAs show that HCAs cause up to 56% of all neonatal deaths among babies born in hospital in developing countries, with 75% of the deaths occurring in South-East Asia and sub-Saharan Africa. Likewise, the burden of infections related to poor WASH in HCFs is particularly high in newborns, for example, severe infections such as sepsis are major killers of newborns. The risks associated with sepsis are reported to be 34 times greater in low-resource settings. Lack of adequate WASH services may also discourage women from giving birth in HCFs or cause delays in health care-seeking (Velleman et al, 2014). However, with improved WASH services women can be attracted to seek antenatal care and deliver in HCFs, which can greatly reduce neonatal and maternal mortality.

Apart from the direct adverse effects of poor WASH on pregnant mothers and newborns, lack of quality water in administering medications such as anti-tuberculosis drugs, de-worming medications, first doses of antibiotics for common infections, zinc and Vitamin A, and oral rehydration solutions can increase the risk of enteric infections in all patients and the risk of opportunistic infections in Human Immunodeficiency Virus (HIV)-infected persons. Therefore, as centres of promoting health and healing, HCFs are required to operate within acceptable standards of personal and environmental cleanliness, which are essentially determined by the availability and accessibility of improved WASH services.

However, though improved WASH in HCFs is a necessary condition of a comprehensive health service and crucial in improving health outcomes, access to such services in health care settings especially in the low and middle-income cluster countries is generally poor. This situation is linked, among other things, with:

- (i) Lack of national policies, guidelines and standards on how to implement WASH in HCFs;
- (ii) Limited financial and human resources for effective and efficient implementation of WASH services; and
- (iii) Lack of clear approach of standardizing and strengthening monitoring mechanisms of WASH interventions in HCFs (WHO/UNICEF, 2015).

## 1.2 Scope of the guidelines

These Guidelines provide guidance in a number of aspects related to the provision of WASH services in HCFs in the country. Specifically, the Guidelines focus on the promotion of WASH services in HCFs, which include: hospitals, health centres and dispensaries. The guidelines largely focus on the following key issues:

- (i) Planning and budgeting;
- (ii) Water supply;
- (iii) Excreta disposal and drainage;
- (iv) Hygiene;
- (v) Cleaning and laundry;
- (vi) WASH services during emergency
- (vii) Control of vector and vermin;
- (viii) Landscape and gardening;
- (ix) Operation and maintenance;
- (x) Monitoring

## 1.3 Users of the guidelines

These guidelines have been developed for use by health managers and planners, DPs, contractors including firms involved in architectural and construction works, water and sanitation staff at different levels, public and private HCWs, health promoters, and other stakeholders. The objective is to ensure that all stakeholders involved, follow the same set of guidelines in providing WASH services in HCFs. In doing so, these guidelines will help to minimize the risks of HCAIs which may be caused by inadequate WASH services in HCFs.

## 1.4 Rationale for developing the guidelines

There are many ongoing initiatives countrywide by various stakeholders to support the improvement of WASH services in HCFs. However, there are no nationally well organised guidelines to guide the provision of such services thus, making it difficult for the MoHCDGEC to monitor and ensure quality control. The absence of guidelines in the provision of WASH services in HCFs leads to lack of uniformity especially with respect to planning and budgeting, technical designing and construction, O&M, quality control and monitoring of such interventions.

Hence, the rationale of developing these guidelines is to have a standardized approach to guide different stakeholders at all levels in their initiatives towards addressing the prevailing WASH related problems in HCFs in Tanzania Mainland. Experience has shown that, in the absence of nationally acceptable guidelines, WASH interventions in HCFs are implemented in a substandard manner. Therefore, development of WASH guidelines will improve the quality of health care services to the people involved in the line of health care services in the country.

## 1.5 Objectives of the guidelines

Overall, these guidelines are intended to put in place a uniform and harmonized approach in the provision of WASH services in public and private HCFs all over the country. The guidelines offer practical guidance for effective and efficient provision of WASH services in HCFs to ultimately contribute to prevention and control of HCAIs, and improvement of quality of health care services in Tanzania Mainland.

Specifically, the guidelines are intended to:

- (i) Provide technical guidance on planning, budgeting, implementation and maintaining WASH services and infrastructures in HCFs.
- (ii) Provide basic information on technical designs and O&M to guide implementation of WASH services for sustainable delivery.
- (iii) Establish systems for monitoring of WASH services in HCFs for continuous quality improvement.

## 1.6 Organization of the document

These WASH guidelines consist of ten chapters. Chapters 1-3 provide general background information on the purpose, rationale, scope of the guidelines and an overview of the WASH situation at global and national levels as well as related national policies, legislations and institutional frameworks. Chapter four describes the fundamental aspects to be considered in planning and budgeting for WASH services in HCFs.

Chapter five of the guidelines describes the provision of water supply in HCFs specifically in ensuring that there is adequate, quality and reliable water at all times for different uses. Chapter six provides different types of sanitation facilities suitable for HCFs and proper management of wastewater, faecal sludge as well as storm water.

Guidelines on maintaining proper hygiene practices within the HCFs environment as one of the most effective ways of preventing acquisition and transmission of HCAs are elaborated in chapter seven. Chapter eight provides guidelines on WASH services delivery during emergencies in HCFs.

Chapter nine gives the guidelines on how to maintain the HCFs surroundings clean and attractive through proper landscaping, gardening. Also, it describes measures for vector/vermin control in HCFs. The final chapter provides the monitoring framework that will be used to assess over time WASH conditions in HCFs.

## CHAPTER TWO

### 2.0 OVERVIEW OF WASH IN HEALTH CARE FACILITIES

This chapter provides an overview of the current situation of WASH services in HCFs both at global and country levels. It cites important findings of various studies which describe the scale of problems related to WASH in HCFs and the subsequent global action plan as well as national strategies to address them.

#### 2.1 WASH in health care facilities: A global perspective

From the global perspective, provision of WASH services in HCFs is low as the current levels of such services are far below the required 100% coverage. This is mainly because globally, provision of improved WASH services in HCFs has for decades not been given deserving attention in relation to the role it plays on socio-economic development and community well-being at large particularly in developing countries. Many HCFs in low-resource settings lack basic WASH services, compromising the ability to provide safe care and presenting serious health risks to staff, patients and carers. Furthermore, compliance with hand hygiene guidelines among HCWs globally is still low. Evidence from a systematic review of 96 studies, which were carried out in hospitals in high-income countries reveals that on average, hand hygiene compliance among HCWs was 40% and considered to be as low as 2.1% in developing countries (WaterAid, 2012).

Inadequate WASH services is widespread in low-and middle-income countries. Findings from the global assessment of 66,101 HCFs from 54 countries to ascertain the extent to which HCFs provide essential WASH services, revealed that, 38% of HCFs lack access even to basic levels of WASH (WHO/UNICEF, 2015). In particular, the same study found that 19% of the facilities did not have improved sanitation and that 35% of facilities did not have water and soap for hand washing.

Due to this alarming situation, access to improved WASH services within the HCFs has become an issue of global major concern, drawing significant attention from different stakeholders including governments, DPs, and the international public health community. The devastating Ebola outbreak in parts of Western Africa in 2015 has highlighted some of the dangerous consequences of poor access to WASH services in HCFs.

#### 2.2 Global initiatives for improved WASH in health care facilities

In order to improve this situation, WHO and UNICEF in collaboration with other WASH partners across the globe have committed to implement a global action plan on WASH in HCFs. The vision of the global action plan is *'to ensure that by 2030, every HCF, in every setting, has a safely managed, reliable water, sanitation and hygiene facilities and practices to meet staff and patient needs in order to provide quality, safe people-centred care, with particular attention to the needs of women, girls and children'* (WHO/UNICEF, 2015). In order to realize this vision five change objectives (COs) have been developed as summarized in Table 2.1.

**Table 2.1: Change objectives for Global Action Plan**

CO1	WASH in HCFs is prioritised as a necessary input to achieving all global and national health goals especially as those linked to universal health coverage. Key decision makers and thought leaders champion WASH in HCFs.
CO2	All countries have national standards and policies on WASH in HCFs and dedicated budgets to improving and maintaining services
CO3	Global and national monitoring efforts include harmonizing core and extended indicators to measure WASH in HCFs
CO4	The existing evidence base is reviewed and strengthened to catalyse advocacy messages and improve implementation of WASH in HCFs.
CO5	HCF staff, management and patients advocate for and champion improved WASH services. Risk-based facility plans are implemented and support continuous WASH improvements, training and practices of health care staff.

Furthermore, several other global health initiatives such as *'Every Woman Every Child'*, the *'Integrated Global Action Plan against Pneumonia and Diarrhoea'*, and *'Quality of Care during Childbirth'* highlight the importance of improved WASH services in HCFs. As a further emphasis the WHO Director General has declared that improving WASH in HCFs is an urgent priority (WHO, 2013). Hence, the large number of actors and funds committed to universal health coverage provides an opportunity to highlight the essential role of WASH in achieving this aim. Nevertheless, despite these advancements, still there exists low political will in terms of countries adopting implementable policies and strategies towards improving access of WASH services in HCFs. For instance, according to the findings of the 2014 UN-Water Global Analysis and Assessment of Sanitation and Drinking-Water (GLAAS), only one quarter of countries have policies on WASH in HCFs that are implemented with funding and regular review.

### 2.3 WHO minimum WASH standards in health care facilities

In order to provide quality health care as well as to minimize risks of acquiring HCAs to patients, staff, carers and visitors, minimum WASH standards in HCFs have been set by the WHO for countries to adopt or make their own standards. The standards cover, among other things; water availability, water quality, water quantity, water facilities and access to water, human excreta disposal, wastewater treatment and disposal, health care waste disposal, cleaning and laundry, food storage and preparation, building design, construction and management, control of vector-borne diseases, information and hygiene promotion. These requirements are detailed in the box below (WHO, 2008).

#### WHO minimum WASH standards in HCFs

- *Availability of safe and adequate water for drinking, medical purposes such as sterilization, surgery and deliveries, food preparation, showering and laundry;*
- *Accessible and clean toilets, separate for men and women in sufficient numbers for staff, patients, visitors, people with special needs such as disabled, very sick people etc;*
- *Improved hand washing practices among health care staff through orientation and training*
- *Proper health care waste management and safe disposal of excreta and wastewater;*
- *Clear and practical communication with patients and visitors, including caregivers about hygiene promotion.*

### 2.4 Overview of WASH in health care facilities in Tanzania

Health care services in Tanzania Mainland are provided by both the public (which includes parastatal organizations) and the private sector. Of the total HCFs, 70% are owned by the public sector. Health care services in both public and private HCFs are hierarchically divided into three levels namely:

- (i) Large HCF consisting of national, specialized, zonal, referral regional and district hospitals, which provide a range of outpatient and inpatient care and in some cases specialized treatment/care. In such HCFs the risk of diseases transmission is relatively substantial since they attract many patients.
- (ii) Medium HCFs specifically health centres which provide outpatient care and a limited number of inpatients including maternity care services and outreach activities.
- (iii) Small HCFs comprising of dispensaries, which mainly provide outpatient care and outreach activities.

Ownership of HCFs in the private sector includes both for profit and not for profit organisations such as NGOs, Faith-Based Organisations (FBOs), and Community-Based Organizations (CBOs). Some FBO-owned HCFs especially at district level are classified by the Ministry as District Designated Hospitals (DDHs). Table 2.2 summarizes the types and numbers of HCFs in Tanzania Mainland by ownership and their levels.



**Table 2.2: HCFs in Tanzania Mainland by level and type of ownership**

Level /Type	Ownership				Total
	Government	FBOs	Parastatal	Private	
National Hospital	1	0	0	0	1
Zonal Super Specialized Hospitals	1	2	1	1	5
Referral Hospitals	0	9	0	0	9
Regional Referral Hospitals	22	0	1	0	23
Other Hospitals	3	19	9	29	60
District Hospitals	70	0	0	0	70
Designated District Hospitals	0	36	0	0	36
Health Centers	514	144	18	125	801
Dispensaries	5093	708	295	1062	7158
Total	5704	918	324	1217	8163

Source: <http://hfrportal.ehealth.go.tz/> (2016)

HCFs in Tanzania Mainland still face challenges in the provision of WASH services. The situation is worse in small HCFs especially those located in remote rural areas. The challenges range from poor water supply both in quantity and quality, unimproved sanitation facilities to poor hygiene practices mainly due to lack of supportive infrastructure and absence of initiatives to promote good hygienic behaviour, which is common in most HCFs (NIMR, 2016).

Results from the 2014-2015 Tanzania Service Provision Assessment (TSPA) survey conducted jointly by the then Ministry of Health and Social Welfare (MoHSW) Tanzania Mainland, Ministry of Health Zanzibar (MoHZ), National Bureau of Statistics (NBS), The Office of the Chief Government Statistician (OCGS) and ICF International show that on average, only 44% of HCFs had functioning toilets, and over 68% of all facilities had an improved water source in the facility. It was noted further that hospitals, in general, do have access to a water source, but supply is often unreliable or intermittent. The situation is particularly grim in lower level HCFs such as dispensaries despite the fact that these are often the first point of contact for people accessing health services including maternal and newborn care services. The survey found out that more than 60% of dispensaries had inadequate toilets.

Further findings from two recently conducted studies in Tanzania Mainland (NIMR, 2016) and Zanzibar (WaterAid, 2015), also reveal a similar picture of the existence of critical shortage of WASH services in HCFs, which compromises the ability to provide basic routine services and thus, limiting them to prevent and control infections. This situation also affects health care seeking behaviour and impacts negatively on maternal and newborn health through multiple direct and indirect mechanisms. The evidence of poor WASH services in HCFs in both Tanzania Mainland and Zanzibar (Malebo, 2015) shows among others, lack of 24 hours access to water in high turnover HCFs, inadequate and poor toilet facilities-either non-functioning flush toilet or dirty and inaccessible pit-latrines, lack of basic hand-washing infrastructure, poor sanitation and inappropriate hygiene practices by frontline health care workers, and contaminated water at point of use. The findings further show that, 42% of HCFs with delivery rooms had no functional hand washing facilities.

A more or less similar situation was reported in another study which found out that less than one third (30.5%) of all births in Tanzania took place in a WATSAN-safe delivery room environment (Benova *et al.*, 2014b). However, the study noted that, reasons why HCFs did not meet the definition of WATSAN-safe



varied between the three facility levels. Among the surveyed hospitals and health centres, more than 90% were classified as WATSAN unsafe as they had unimproved water sources, whereas, among the dispensaries, the estimate was 82%. A substantial proportion of dispensaries accounting for 15% lacked both improved water supply sources and improved sanitation facilities.

Also, the GIZ baseline assessment of the WASH situation in selected HCFs in Tanzania Mainland identified specific gaps within technical infrastructure and capacities as shown in Table 2.3.

**Table 2.3: Gaps in WASH services in selected health care facilities**

Area	Identified Gaps
Technical Infrastructure	<ul style="list-style-type: none"> <li>• Intermittent water supply by utilities</li> <li>• Potential of rain water harvesting and boreholes not fully exploited</li> <li>• Flush system of toilets often broken</li> <li>• No sanitary facilities for physically challenged patients</li> <li>• Sinks and showers often malfunctioning</li> </ul>
Capacities	<ul style="list-style-type: none"> <li>• Operation and maintenance is limited due to reduced number of qualified personnel</li> <li>• Inadequate fund for the purchase of spare parts</li> <li>• Guidelines for WASH in HCFs does not exist</li> <li>• Health sector highly dependent on donors' contributions</li> </ul>

**Source:** GIZ (2014): *WASH in HCFs in Tanzania:*

([http://www.swsd.or.tz/fileadmin/downloads/2014/Factsheet\\_Sanitation\\_in\\_HCFs.pdf](http://www.swsd.or.tz/fileadmin/downloads/2014/Factsheet_Sanitation_in_HCFs.pdf))

Undoubtedly, if this situation remains unabated, it is likely to remain unchanged in the next decades to come, resulting into high maternal and child mortality rates.

## 2.5 Strategies for improving WASH in health care facilities in Tanzania

In line with the global initiatives, the Government of Tanzania (GoT) through MoHCDGEC in collaboration with various DPs has recognized the need to urgently address WASH challenges in HCFs. These efforts include the earmarking of sanitation by the Water Sector Development Programme (WSDP) Phase II (MoWI, 2014) as an independent component in which WASH in HCFs has been identified as a priority area. Under this programme 1,000 HCFs will be provided with improved WASH services nationwide. Remarkably, this intervention opens a window of opportunity to enable develop joint products and approaches that will help to improve the WASH situation in and around HCFs in Tanzania.

Other initiatives towards improving WASH services in HCFs are supported by DPs like the Swiss Development Corporation (SDC), UNICEF, WaterAid, SIMAVI, GIZ, and SNV in different regions in Tanzania Mainland through earmarked funding. More importantly, the development of these guidelines is part of the government's initiatives to ensure that WASH services in HCFs are improved in a uniform manner through which the minimum standards are set to minimize the WASH related infections to patients, HCWs and carers.

## CHAPTER THREE

### 3.0 LEGAL AND INSTITUTIONAL FRAMEWORK FOR WASH IN HEALTH CARE FACILITIES IN TANZANIA

#### 3.1 Overview

This chapter provides a succinct summary of policies, legal and institutional framework related to WASH with a view to understand the extent to which WASH is a public health issue of major concern in Tanzania and the extent to which it supports the promotion of WASH in HCFs. All these policies reflect requirements as outlined in the National Development Vision (NDV) 2025. Specifically, the NDV 2025 aims among other things, at achieving a universal access to primary health care and 75% reduction in infant and maternal mortality rates. Impliedly, provision of adequate WASH services in HCFs is one area that can guarantee the realization of this ambition of reduction in infant and maternal mortality, as these groups are the most vulnerable.

The following national policies, strategies and legislations have been reviewed. The list of documents provided hereunder is likely not to be exhaustive due to the fact that WASH is multi-sectoral. Nevertheless, the review has tried as much as possible to cover the key sector guiding instruments as listed below:

- (i) National Health Policy, 2007
- (ii) National Water Policy, 2002
- (iii) National Environmental Policy, 1997
- (iv) Community Development Policy, 1996
- (v) The National Environmental Health, Hygiene and Sanitation Strategy (NEHHSAS 2008-2017)
- (vi) National Health Strategic Plan IV
- (vii) The Public Health Act, 2009
- (viii) Environmental Management Act, 2004
- (ix) The Tanzania Occupational Health and Safety Act, 2003
- (x) Industrial and Consumer Chemicals (Management and control) Act, 2003
- (xi) The Local Government (District and Municipal Authorities) Act, 1982 as amended on 30<sup>th</sup> June 2000
- (xii) Energy and Water Utilities Regulatory Authority Act, 2001
- (xiii) The National Water Sector Development Strategy 2006-2015
- (xiv) Water Supply and Sanitation Act No 12, 2009
- (xv) The Water Resources Management Act, 2009
- (xvi) Tanzania Food, Drug and Cosmetics Act, 2003 (Food Hygiene Regulation, 2006).
- (xvii) Environmental Management Act, 2004 (Water Quality Regulation, 2007).

#### 3.2 Related Sectoral National Policies

##### 3.2.1 National Health Policy 2007

The Policy emphasizes on provision of basic health services that are of good quality, equitable, accessible, affordable, and sustainable and gender sensitive. This can be achieved through among other things ensuring availability of adequate water, sanitation and hygiene services within the HCFs. In recognition of this, the National Health Policy outlines several objectives relating to environmental health, hygiene and sanitation that include:-

- (i) Reduction of morbidity and mortality and increase life expectancy for all Tanzanians by delivering better health services, which focus on requirements for vulnerable groups such as under-fives, people with disability, women of reproductive age and elderly.
- (ii) Prevention and control of communicable and non-communicable diseases particularly HIV/AIDS, malaria, tuberculosis, diabetes, cancers, hypertension, diseases resulting from mismanagement of chemicals, poor nutrition, environmental and working conditions.

- (iii) Sensitization of the community on common preventable health problems and, improve the capabilities at all levels of the society to identify, analyze challenges and design appropriate actions.
- (iv) Enhancing collaboration for health service delivery between public sector, private sector, faith-based organizations, civil society and the community.
- (v) Planning, training and increasing the number of qualified health professionals taking into account gender sensitivity for the delivery of service at all levels.
- (vi) Rehabilitate and construct infrastructure to accommodate the requirements of people with disabilities (people with special needs), and establish a system for preventive maintenance of health facilities, equipment and working tools.
- (vii) Review and evaluate health policy, guidelines, laws and standards of health service delivery.

### **3.2.2 National Water Policy 2002**

The National Water Policy (NAWAPO) of 2002 facilitates the attainment of the NDV through water supply. NAWAPO recognizes that lack of safe water; poor hygiene and sanitation are major causes of sicknesses and deaths in the country. Therefore, the Policy underscores the need to integrate water supply, sanitation and hygiene for improved health impacts of water and sanitation interventions. In this connection, the policy emphasizes that sufficient supply of water and adequate means of sanitation are basic human needs.

### **3.2.3 National Environmental Policy 1997**

The policy provides a framework for mainstreaming environment including environmental health into planning and implementation framework of Government institutions in an integral manner. It also specifies the major environmental problems facing the country. The National Environmental Policy thus provides the context for improved Environmental Health, Hygiene and Sanitation to protect public health and promote social wellbeing.

### **3.2.4 Community Development Policy 1996**

This policy recognizes that sufficient clean and safe water, clean and healthy environment are critical elements for community development. It indicates clearly the need for provision of WASH services to enhance the quality of health care services in HCFs and at the same time support the entire community development initiatives and plans.

## **3.3 Related National Legislations**

### **3.3.1 Environmental Management Act, 2004**

The Act recognizes the right to clean, safe and healthy environment by all citizens to the various public elements or segments of the environment for recreational, educational, health, spiritual, cultural and economic purposes. In this context, having adequate WASH services within the health care facilities is critical for the benefits of service providers, patients, and caretakers or visitors.

### **3.3.2 The Tanzania Occupational Health and Safety Act, 2003**

This Act stipulates among other things health and welfare provisions specifically supply of drinking water, sanitary conveniences for people with special needs and provision of washing facilities in public places.

### **3.3.3 Public Health Act, 2009**

The Tanzania Public Health Act 2009 emphasizes a number of issues that are of public concern including sanitation and hygiene, management of hazardous health care wastes for infection prevention and control (IPC). Also, it stipulates that public buildings should be equipped with sufficient sanitary facilities.

### **3.3.4 The Local Government (District and Urban Authorities) Act, 1982 as amended on 30 June, 2000**

This act spells out the requirements to the sanitation of buildings and the cleanliness of yards or compounds and as to the construction and maintenance of toilets and other sanitary structures. The First Schedule of the Act specifically assigns Local Government Authorities (LGAs) the authority to “build, equip and maintain, or grant sums of money towards the establishment, equipment and maintenance of hospitals, health centres, maternity clinics, (and) dispensaries.”

### **3.3.5 Energy and Water Utilities Regulatory Authority (EWURA) Act, 2001**

The general functions of EWURA are to regulate the provision of water supply and sanitation services by a water authority or other person including the establishment of standards relating to equipment and tariffs chargeable for the provisions of water supply and sanitation services in the country.

### **3.3.6 Water Supply and Sanitation Act No. 12 (2009)**

The Act provides the legal framework for water supply and sanitation in both rural and urban areas. It outlines legal mandates and responsibilities of Urban Water Supply and Sanitation Authorities (UWSSAs) in urban areas and Community Owned Water Supply Organisations (COWSOs) in community managed water supply systems mainly in rural and peri-urban settings.

### **3.3.7 Water Resources Management Act, 2009**

The Water Resources Management Act provides for the institutional and legal framework for sustainable management and development of water resources. Specifically, it outlines the principles for water resources management, and prevention and control of water pollution. In this regard, the legislation provides guidelines and standards for construction and maintenance of water resources structures including issuance and operation of water permits and registration of boreholes. This legislation is particularly important for HCFs, which opt to develop their own water sources such as drilled boreholes.

## **3.4 Related National Strategies**

### **3.4.1 The National Water Sector Development Strategy 2006-2015**

The National Water Sector Development Strategy (WSDS) sets out mechanisms for implementing NAWAPO, which aims at achieving sustainable development in the sector through an “efficient use of water resources and efforts to increase the availability of water and sanitation services.” The strategy also stipulates the institutional linkages of various sector actors specifically the roles and responsibilities of line ministries, DPs, UWSSAs, LGAs, COWSOs and the private sector in planning, financing, implementing, and quality assurance, M&E of water supply and sanitation activities (Water sector line ministries). In the same vein the National Water Sector Development Program (WSDP) of 2006-2025 sets out to promote the integration of water supply and sanitation with hygiene education.

### **3.4.2 The National Environmental Health, Hygiene and Sanitation Strategy (NEHHSAS 2008-2017)**

The National Environmental Health, Hygiene and Sanitation Strategy (NEHHSAS) has its overall goal of improving the status of environmental health in Tanzania focusing on providing equitable, quality and affordable environmental health, sanitation and hygiene services to all Tanzanians taking into account gender, through participatory and sustainable approaches. Specifically, the strategy stipulates the need of mainstreaming environmental health into the strategic planning frameworks of the Councils as well as costing ensuing activities. To this effect, Councils will be provided with technical assistance to enable them develop costed council environmental health action plans including developing strategic partnerships with other stakeholders involved in the delivery of environmental services in their jurisdiction.

### 3.5 Institutional framework

#### 3.5.1 National level

For a functional and sustainable WASH system in HCFs it is important to identify the main actors who are involved and clarify their roles and responsibilities. At National level, WASH services are coordinated by MoHCDGEC as the lead ministry. The ministry is responsible for the development and coordination of policies, strategies, guidelines, legislation and regulation as well as setting standards for sanitation and hygiene in the country of which WASH is an integral component for provision of quality health services provided by HCFs at all levels. On the other hand, the Ministry of Water and Irrigation (MoWI) is primarily responsible for water supply in urban and rural areas. In order to expedite the pace of improvement of sanitation and hygiene services, an integrated approach for implementation of sanitation and hygiene endeavours has been adapted in which the MoHCDGEC has entered into an arrangement with three line ministries. These are MoWI, Ministry of Education, Science and Technology (MoEST) and President's Office-Regional Administration and Local Government (PO-RALG). The same institutional arrangement of implementation is reflected at the levels of the Regional Secretariat (RS) and Local Government Authorities (LGAs) where the Departments of Water, Education, Health, Community Development, Infrastructure/Works, and Environment and Solid Waste Management collaborate in the implementation of the WASH delivery to communities. For example, the National Sanitation Campaign (NSC) is implemented through this institutional arrangement (MoHSW, 2014).

In terms of planning, the Government has adopted a Sector-Wide Approach to Planning (SWAp) since 2006 whereby the Government and DPs maintain a common implementation agreement under the leadership of the Government and through pooled funding and/or earmarked budgets (MoWI, 2007). Sector dialogues between stakeholders (the ministries, DPs, NGOs, and CSOs and private sector) are carried out through the National Sanitation and Hygiene Technical Committee (NSHTC), which is chaired by the Assistant Director of Environmental Health and Sanitation, MoHCDGEC. Other members of the NSHTC are the responsible directorates from the line ministries forming the agreement.

#### 3.6 Regional and Council levels Health Management Teams

In principle, the governance structure of the HCFs from Regional to Council level operates through a cascading system in which the Regional Health Management Teams (RHMTs) and Council Health Management Teams (CHMTs) are responsible for HCFs within their administrative areas. On one hand, RHMTs are responsible for supervising management of health services within their region. They advise the Regional Secretariat on how best to improve and maintain the health status, as well as overall planning, implementation and M&E of quality health care within their region. As far as HCFs are concerned, RHMTs are responsible to directly oversee regional referral hospitals and monitor CHMTs performance.

On the other hand, the Decentralization by Devolution (D by D) principle under the Local Government Reform Programme (LGRP II) places the councils through CHMTs as accountable structures for health sector performance within the district. Specifically, CHMTs are in principle responsible for planning and supervision of all aspects of HCFs, including those delivered by FBOs and private sector.

#### 3.7 Council Health Service Boards and Health Care Facility Governing Committees

The effective functioning of the Council Health Services Boards (CHSBs) and Health Care Facility Governing Committees (HCFGs) are required to contribute to the improvement of the governance dimension of health services including WASH services within the district/municipality. The prime responsibility of CHSBs is to ensure that the CHMTs facilitate provision of quality cost effective and sustainable health services taking into account equity concerns. All Boards have the capacity to decide and mobilize resources to strengthen WASH services in HCFs. It is therefore crucial for LGAs to ensure that these structures are empowered through active participation of their members and give them an independent voice in key management processes in order to enable them provide governance and oversight to health services.

### **3.8 Health Facility Management Teams**

Although HCFs within the district operate with some degree of autonomy on a day to day basis, they need to be supervised by their respective CHMTs which are ultimately fully accountable for all aspects of their operations. Other large hospitals including regional and national level including specialized/consultant hospitals have their own autonomous management set ups. Hence, the coordination and management of WASH activities at each HCF is, in principle, the responsibility of the health facility managers specifically the Health Care facility in-charge, in line with the mandates specified in various relevant policies and legislations.



## CHAPTER FOUR

### 4.0 PLANNING AND BUDGETING FOR WASH IN HEALTH CARE FACILITIES

#### 4.1 Introduction

Planning and budgeting are the most fundamental aspects that influence any sectoral development. If not appropriately dealt with, they can affect the progress or expected achievements. Thus, these guidelines consider planning and budgeting for WASH in HCFs to be of paramount importance for they are likely to affect the realization of WASH interventions that are geared towards improvement of health care services.

This chapter provides a step-by-step guide on how HCFs should plan for and finance improvement of WASH at every level of HCF in the country with a view to maintain a sanitary health care environment for IPC. The prime objective is to make optimal use of the allocated/available resources and addressing financial resource gaps for WASH improvement.

It is emphasized that while planning for WASH interventions, existing government guidelines for planning and budgeting for different activities in HCFs should be upheld. For example, for HCFs at council level, situational analysis and needs assessment to determine WASH requirements and associated activities at the HCFs should be integrated into the annual plans and budgets. Moreover, relevant bodies such as CHMTs, CHSBs, HCFGCs should be involved during the planning stage.

#### 4.2 Planning for WASH activities in health care facilities

##### 4.2.1 Planning Process

In planning for improvement of WASH services in HCFs, LGAs should as much as possible adhere to the following steps:

##### **Step 1: Conduct needs assessment for WASH services in health care facilities**

This assessment will help in establishing the WASH needs and feasibility. Councils in collaboration with HCFMTs and HCFGCs are required to conduct thorough needs assessment for WASH services in all HCFs under their jurisdiction.

##### **Step 2: Scrutinize WASH plans**

Each council should ensure the inclusion of WASH activities in plans and budgets of HCFs within its area of authority.

##### **Step 3: Establish costs for each identified WASH needs**

Within the CCHPs, WASH activities for each level of facility should be captured and allocated funds. The fund so allocated should aim at facilitating the operation and maintenance of WASH services and for construction of new facilities when need arises.

##### **Step 4: Prioritize WASH needs**

Prioritizing of WASH activities in the council plans should be guided by the following considerations:

- (i) Activities or jobs must be categorized as either minor or major works. Minor works refer to things like fixing and installation of new water pipes, doors or water trap, while major works include building a new structure, changing the entire roofs and ceiling etc. Categorization is important in determining the level of engagement of technical people and in the process of contracting.

- (ii) Activities should be prioritized with the support from Council experts in order to review the planned technical options in order to determine if they are socially acceptable, financially feasible and environmentally suitable.
- (iii) The plan should include initial investment costs, maintenance, replacement and extension of services.

#### **Step 5: Explore different sources of funding for WASH interventions**

Sources could be either from central government, council own sources, DPs, private sector or community. It is important to indicate in the budget the sources of funds. Specifically, as per health sector resource flow in Tanzania, the major sources for financing health related interventions include central government through subvention, Capital Development Grant (CDG), the Health Sector Basket Fund (HSBF), comprising funds from DPs in the form of grants and or loans, collected user fees or cost-sharing charges from community for services rendered by HCFs, Community Health Fund (CHF) and funds from health insurances and NGOs.

#### **Step 6: Resource prioritization for new WASH interventions or improvements**

Planners should aim at WASH needs that can be addressed in short, intermediate or long term. This will help in establishing what costs need to be included in the budget as well as the timeframe for the budget. During formulation of the budget, resource prioritization and performance linking should be applied. That is, with a critical situation analysis of WASH services, it will be much easier for HCF management to select for inclusion in the budget activities with the highest impact.

### **4.3 Funds allocation criteria**

Given the fact that resources are limited compared to the needs of HCFs for both recurrent and development expenditures, allocation of resources to different WASH activities should be based on the following:

- (i) The list of priority WASH needs as per results of the situational analysis.
- (ii) HCFs with highest demand for WASH activities such as those with relatively poor WASH services should be given priority in the allocation of the available funds.
- (iii) For immediate impact of the investment, priority should be given to upgrading activities, repair and maintenance.
- (iv) Priority should be given to HCFs, which have high demands and have committed own resources, which require matching.
- (v) WASH activities that are of great demand to vulnerable groups such as pregnant women, children under-five years of age, people with special needs and immune-compromised individuals.

### **4.4 Major considerations in planning and designing of WASH interventions**

There are several important considerations for planning and designing of WASH interventions in HCFs without which the intended benefits cannot be realized. Apart from the technical design choices which are often based on the financial resources, physical conditions and prevailing socio-economic circumstances, there are other aspects, which should be reflected clearly in the plans for WASH interventions. This section highlights the major considerations which planners should give special attention while putting together their WASH plans for HCFs.

#### **4.4.1 WASH plans as integral part of CCHP**

WASH plans in HCFs at Council level should be part of the Comprehensive Council Health Plan (CCHP) and in line with national health planning guidelines. In line with the CCHP planning guidelines the planned intervention should be well addressed in the situational analysis and set out clear interventions, targets and respective activities. It is recommended that at least 15% of the HCF's budget should be allocated for WASH services in respective facility.



#### 4.4.2 Involvement of community/users

WASH facilities should be planned and designed with the involvement of the community around the HCFs and the users. Active involvement of the users or potential users is essential in all phases of any design process.

#### 4.4.3 Strategic partnership with other stakeholders

There are a number of agencies (public and private) such as political leaders, local and international NGOs, Faith Based Organizations (FBO), United Nations (UN) and bilateral donors that are either currently involved or would be involved in the improvement of WASH services in HCFs. Planners should in collaboration with MoHCDGEC purposely include in the CCHPs initiatives for collaboration with such partners.

#### 4.4.4 Choice of low-cost and quality WASH facilities

The starting point for choosing the most appropriate technical solution is the baseline assessment of WASH needs at each HCFs. Normally, the existing situation assessment will bring to light which facilities need upgrading or improvement up to the required standards. In case construction of new WASH facilities is preferred, planners should consider low cost options but without compromising quality. It is recommended therefore, that planners should have a package of technical design options of WASH facilities and their estimated costs from which they can choose the most appropriate, affordable and durable ones and easy to maintain and clean.

#### 4.4.5 WASH facilities for people with special needs

Very rarely, adaptations for the disabled or seriously sick patients are incorporated into the design of WASH facilities. It is important for planners and technical designers to take note that not all the potential users of the WASH facilities will have normal physical abilities as they will include those with physical disabilities or chronically and seriously sick individuals. Nevertheless, the incorporation of technical designs for these users with special needs into the original designs can be made at little or no additional costs.

#### 4.4.6 Needs for women, girls and children

Planners should be aware that some WASH needs are gender specific. This is because of different physical needs and socio-culturally determined roles, which men and boys do not have. One of the most important considerations when designing WASH facilities should be provision of a proper environment for menstrual hygiene management (MHM). As such they need adequate toilets and water supplies to comfortably change and dispose of sanitary pads and to attend themselves in privacy during menstruation. In other words, provision of inadequate WASH facilities is particularly detrimental to the dignity and social development of women and girls and at worse discriminatory.

Children requirements should be taken into consideration so as to use designs that adapt well with their physical stature. It is recommended to consider the following child-size dimensions in the design of WASH facilities in the HCFs:

- (i) Height of taps and hand-washing facilities.
- (ii) Height of doorknobs and locks
- (iii) Height of steps and handrails of stairs in toilets and for water and hand wash facilities
- (iv) Height of toilets seats in case seats are to be used
- (v) In urinals, distance from the squatting platform into the wall.
- (vi) If elevated urinals are being used consider the height of urinals
- (vii) Diameter of the squatting hole (consider children's fear of falling in the toilet)

Again, since children have different levels of physical strength and motor skills than adults the following aspects have to be considered and measured:

- (i) Force needed to open toilet doors
- (ii) Strength needed to open taps, fetch water, etc.

For the youngest children up to 8 years, WASH facilities and adaptations should be made to allow for adults to supervise and/or help when children are using them.

#### **4.4.7 Environmental safeguards**

Environmental safeguards refer to measures required to effectively avoid undue harm to people and their environment. For instance some facilities are likely to pose soil and groundwater contamination, while others may produce wastewater flows. Hence, it is necessary for planners and designers to avoid pollution of ground and surface water sources by locating toilets at least 60 metres away from water sources. Hence, measures to reduce these negative effects and hazards to the environment should be an integral part of WASH facilities planning, designing, implementation and O&M.

#### **4.4.8 Sustainability plans**

The issues regarding sustainability of the improved WASH facilities should not be overlooked during planning and designing. The purpose is to ensure that the constructed facilities continue to provide the intended services for a longer period. Therefore, a clear sustainability strategy should be embedded in the WASH plans so that the facilities are properly looked at after construction. The sustainability strategy should include the O&M plans and reliable sources of funding for WASH facilities

## CHAPTER FIVE

### 5.0 WATER SUPPLY IN HEALTH CARE FACILITIES

#### 5.1 Water needs in health care facilities

HCFs are ranked among institutions which have a relatively high Water Use Intensity (WUI) and hence, require to have access to adequate supply of water at all times in order to maintain daily patients' care services and other operations. Adequacy of water should be in terms of quantity, quality, reliability and accessibility.

Though the uses of water vary depending on the facility level, it is important for each HCF to develop a water supply plan. This chapter therefore provides a general guide on how to plan and implement water supply interventions in HCFs including water supply related features such as quantity of water required for different uses, water quality, treatment, protection, storage and technical designs of water supply options.

#### 5.2 Water sources

##### 5.2.1 Types of water sources

HCFs can access water from the following three main sources:

- (i) **Ground water sources:** These are sources whereby water is obtained from beneath the surface in rocks and soil, and accumulates underground in aquifers. Ground water can be of three types depending on the method of water drilling and the depths of occurrence and bearing stratum. These are shallow wells which their depths are not beyond 20 meters, medium well with depth of 20-35 meters and deep wells with depth greater than 35 meters

The advantages of ground water include:

- (i) Mostly safe and it does not need as much treatment as surface water.
  - (ii) For deep ground water sources, water availability is throughout the seasons
  - (iii) Water quality is relatively constant.
- (ii) **Surface water sources:** These are sources whereby water is collected on the surface of the earth. They include lakes, rivers, dams, ponds or wetlands. Water from these sources can be obtained by HCF by either using vehicle (water bowser) or can be pumped to the facility. Some surface water sources like large lakes and rivers can be accessed throughout the year. The advantage of this source is that water is generally softer compared to groundwater. However, water from surface sources is prone to contamination.
- (iii) **Rain Water Harvesting (RWH) System:** This is an alternative source that can ensure availability of water in HCFs, especially in areas with water scarcity or intermittent water supply. The capacity of RWH depends on the quality of the collecting surface (roof), storage capacity and the rainfall seasons in a respective area (once or twice per year). The main advantage of rain water is that it is normally clean and natural, especially if collected from buildings roofed with non-rusty corrugated iron sheets or tiles and clean gutters and stored in clean and closed tanks.

##### 5.2.2 Basic considerations in selecting appropriate water sources for HCFs

In selecting any of the mentioned water sources in section 5.2.1, HCFs should take into account the following:

- (i) **Water Quantity:** The quantity of water must be adequate for the current and future demand of the HCF.

- (ii) **Water Quality:** The quality of water should be such that, after appropriate treatment, meets the specified standards in this guideline.
- (iii) **Protection of Water Sources:** Water sources selected should be protected from pollution and contamination by observing the following:
- (i) Domestic livestock and other animals should be kept away from the intake by fencing the area of a minimum radius of 60 meters from the installation
  - (ii) Defecation, urination, burial grounds and disposal of other solid and liquid wastes around the intake should be completely prohibited and preferably a sign post should be installed at the area reminding the public on this prohibition
  - (iii) Drainage and run off waters should be led away from intakes
  - (iv) The water source should be guarded against inundation by the flooding of nearby rivers
  - (v) Soil erosion should be prevented by reforestation and other practical methods
  - (vi) Algal growth should be prevented by draining swamps and pools around the intake or reservoir
- (iv) **Feasibility:** The selected source should be amenable to being exploited using appropriate technology and within reasonable costs considering both capital and O&M costs such as use of simple and reliable treatment and transmission technology.

**REMEMBER!**

*The choice of water sources is very crucial before embarking on installation for a water supply system as it may be irrelevant or very costly and with short life span. Factors that should influence HCFs to choose the type of water sources should include:*

- *Existence of public water supply utilities within the proximity of the HCFs such as community or urban piped water supply systems from which an extension to the HCFs is feasible,*
- *Favourable hydro-geological conditions within the HCFs premises or nearby,*
- *Relatively low costs of borehole drilling especially due to topographical features and easy access to borehole drilling site, and*
- *Availability of sufficient funding*

**5.2.3 Selection of available and feasible options of water sources**

Upgrading of water supply in HCFs should focus on rehabilitation and/or construction of water supply facilities depending on the conditions of the existing water supply facilities and the available funding. In this regard, the most feasible options available to HCFs include connection to existing water supply networks, drilling or digging own wells, tapping water from protected springs and installation of RWH systems.

**5.3 Recommended water sources for each facility level**

In principle, in planning and designing WASH facilities HCFs should adhere to the global definitions of improved water sources as outlined by the WHO/UNICEF/JMP. The JMP definition of ‘improved water sources’ is used as a reasonable accurate proxy indicator for ‘clean and safe water’ and much easier to monitor than water quality. However, caution should be taken that improved water sources will not always provide truly clean and safe water, which opt for regular treatment and periodic monitoring.

**WHO/UNICEF/JMP Definitions of Improved Water Sources**

- *Piped water into dwelling, plot or yard*
- *Public standpipe/tap*
- *Borehole/tube well*
- *Protected dug well*
- *Protected spring*
- *Rainwater harvesting*

Table 5.1 provides a list of options of water sources recommended for each facility level.

**Table 5.1: Recommended water sources per health care facilities level**

Health Care facility level	Recommended water sources
Dispensaries	<ul style="list-style-type: none"> <li>• Must be connected to existing water supply system, either public or any other water source approved by local authority.</li> <li>• Installment of RWH system is compulsory</li> <li>• Protected shallow well fitted with a hand pump or connected to the storage tank</li> <li>• Drilled borehole</li> <li>• Pumped water from a protected spring</li> </ul>
Health Centres	<ul style="list-style-type: none"> <li>• Must be connected to existing water supply system, either public or any other water source approved by local authority.</li> <li>• Installment of RWH system is compulsory</li> <li>• Protected shallow well with fitted hand pump or connected to the storage tank</li> <li>• Drilled borehole</li> <li>• Pumped water from a protected spring</li> </ul>
District/council Hospitals	<ul style="list-style-type: none"> <li>• Must be connected to existing water supply system, either public or any other water source approved by local authority.</li> <li>• Installation of RWH system is compulsory</li> <li>• Drilled borehole with piped system if feasible</li> <li>• Pumped water from protected spring</li> </ul>
Regional Referral Hospitals	<ul style="list-style-type: none"> <li>• Must be connected to existing water supply system, either public or any other water source approved by local authority.</li> <li>• RWH system installation is compulsory</li> <li>• Drilled borehole with piped system if feasible</li> <li>• Pumped water from protected spring</li> </ul>
National Hospitals	<ul style="list-style-type: none"> <li>• Must be connected to existing water supply system, either public or any other water source approved by local authority.</li> <li>• RWH system installation is compulsory</li> <li>• Drilled borehole with piped system</li> <li>• Pumped water from protected spring</li> </ul>

### 5.3.1 Connection to existing water supply systems

Most of the HCFs located in regional headquarters or in small towns are either connected to water supply distribution networks operated by respective UWSSAs or have a potential of doing so. Also, there are HCFs situated in rural areas where rural piped water supply systems owned by COWSOs are in operation. All these should be considered as opportunities for such HCFs to access reliable water supply by extending connections to their premises. However, given that there might occur interruptions in the distribution of water from the existing piped schemes, it is strongly recommended that a backup should be provided to ensure that the supply is reliable. In this case storage facilities such as reservoir tanks or a deep well for providing water at least for 3 days should be installed within the HCFs premises. While UWSSAs will normally provide extension of pipes to the premises, HCFs will require contracting out the services of improving in-house distribution network and installation of storage facilities to local water technicians/plumbers.

### 5.3.2 Development of own water sources

HCFs located in areas where there are no piped schemes either owned or operated by UWSSAs or COWSOs, will have to develop their own water sources. The most likely options would be drilled boreholes (medium or deep wells), protected shallow wells and springs. However, mechanized drilling is relatively costly and therefore, HCFs which choose this option should take into account the financial feasibility.

### 5.3.2.1 Construction of boreholes

Mechanical methods are used to develop boreholes. Below are the steps to be followed in constructing boreholes:

- (i) **Selection of the water well site:** This is a preliminary stage of investigations involving hydro-geological survey in order to access information on the composition of the ground, water discharges and quality. In order to undertake hydro-geological survey, HCFs will have to use specialized professionals from respective Councils or Water Basin Offices (WBOs) who will execute the survey and interpret the results. As a matter of practice, boreholes should not be drilled within a short distance so as to avoid sharing the same aquifer. The recommended distance from one borehole to another should be 300 m apart unless there is acceptable data indicating the contrary.
- (ii) **Actual drilling:** There are several drilling methods which can be applied depending on the location of the HCF and the geological formations of the area such as type of terrain, nature of aquifer and above all the financial implications. Generally, percussion and rotary drilling methods are the most applicable techniques for drilling in igneous and metamorphic rocks.
- (iii) **Water well development:** This activity is commonly done before the pumping test is carried out and it aims at removing all finer particles which can block easy movement of water in the well so as to attain the maximum yield.
- (iv) **Water well completion:** This step is a preparation of a well for use which will include installation of casing, screen and gravel pack in order to ensure sand-free operation at maximum yield, pump testing, and water sampling and installation of a water-lifting device to raise groundwater into a reservoir tank. The major factors which should be considered in well completion will include:
  - (i) Concreting the area and capping the borehole
  - (ii) Protecting the area against pollution, risk of flooding and other possible sources of contamination
  - (iii) Ensuring that the well head design will prevent the borehole from being flooded
  - (iv) Filling the completion form explaining clearly the lithological column
  - (v) Formal registration of the borehole by WBO
  - (vi) Commissioning of the borehole and labelling

### 5.3.2.2 Construction of protected shallow wells

Drilled shallow wells can be optional sources of water for HCFs especially where those located far away from urban or community water supply systems. Many shallow wells are not perennial as they dry up during extended drought periods. In order to maintain acceptable water levels, it is recommended that protected shallow wells should be constructed during the dry season when water levels are at their lowest. The cross sectional parts of a shallow well are as presented in Figure 5.2.

It should be noted that, though protected shallow wells have the advantage of being less costly if appropriate safety measures are not taken they are easily susceptible to bacteriological contamination especially if located near a toilet, soak ways or any other contaminants nearby. Thus, HCFs that choose this option should ensure that the water quality is regularly monitored for microbiological, chemical and physical contaminants and particularly the storage facilities and network system.



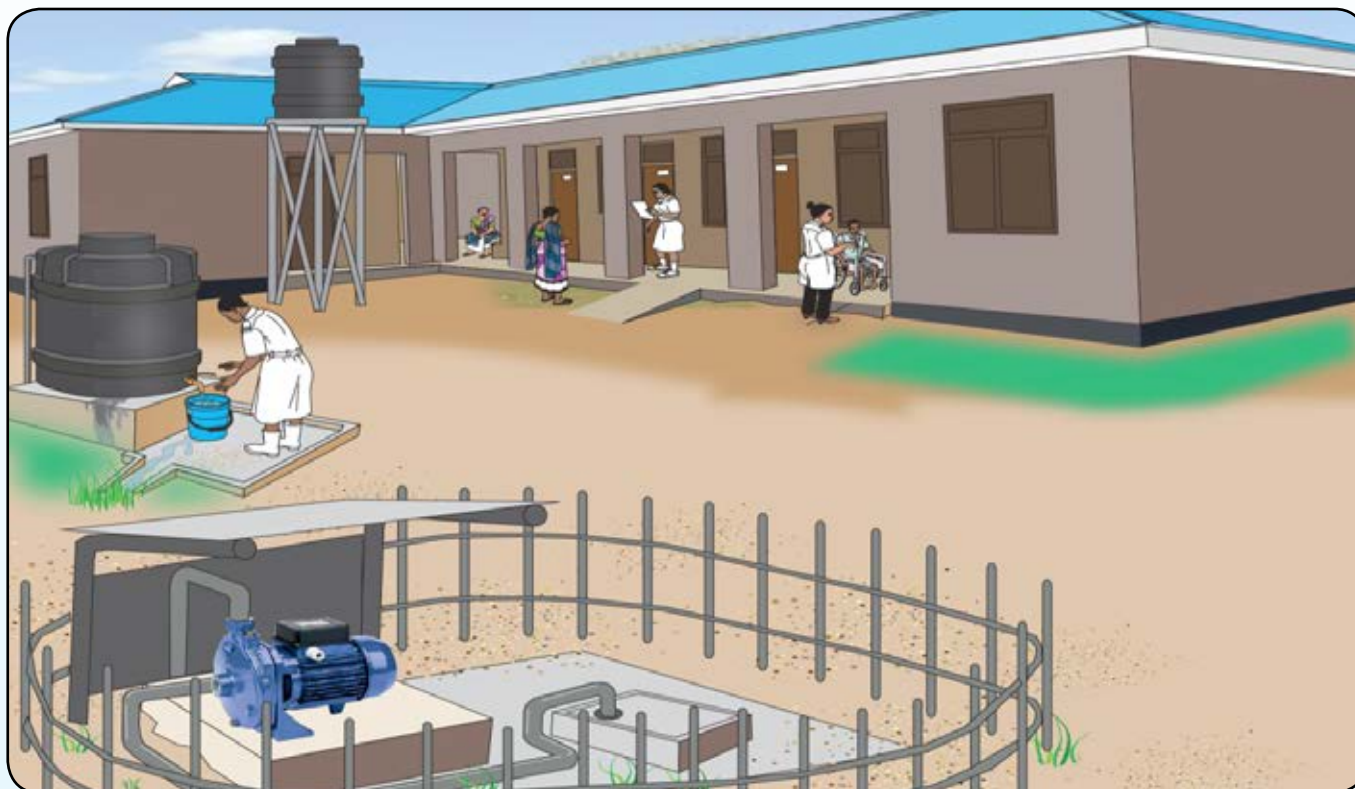

**Figure 5.1: Protected water well at health centre**

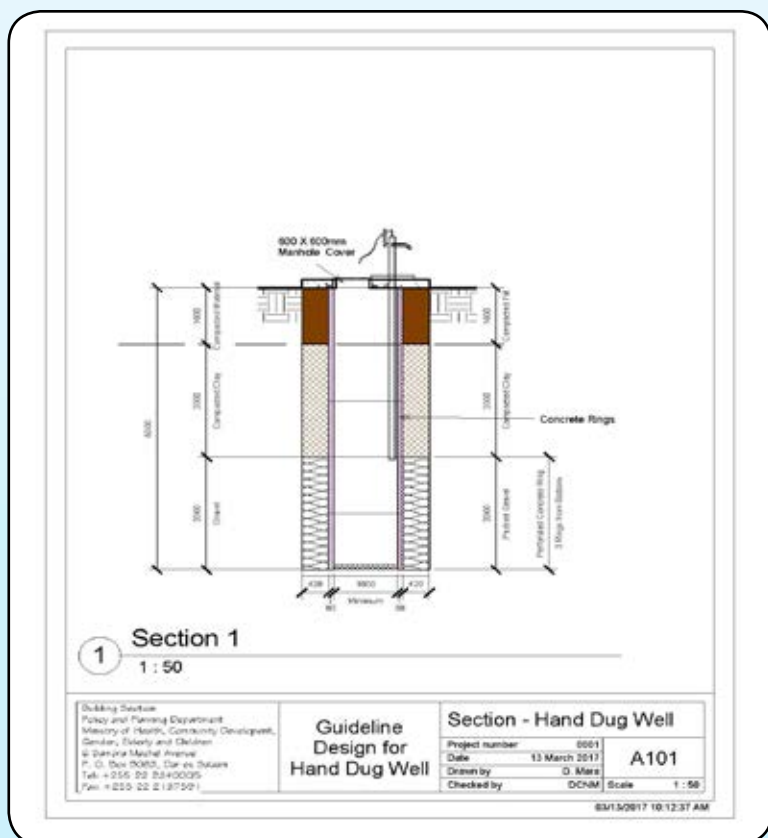

**Figure 5.2: Cross-section parts of a shallow well**

In developing a protected shallow well, HCFs should take into account the following instructions:

- (i) Well diameter should not exceed 1.5 meters
- (ii) Water column should not be less than 3 meters
- (iii) Well should be lined with bricks or concrete rings
- (iv) Well should be fitted with a hand pump to enable water accessibility within HCFs
- (v) Well should be sealed with apron and must have a spill over
- (vi) Toilets and septic tanks, soak ways should be located downstream of the well at least 60 meters from the existing water source within the premise
- (vii) Avoid digging wells in sandy deposits as they are prone to biological contamination.

### 5.3.3 Operation and maintenance of water supply systems

The objective of an efficient O&M management of a water supply system in HCFs is to provide safe water as per designed quality and quantity with adequate pressure at convenient location and time on a sustainable basis. O&M includes routine maintenance, minor repairs and corrective maintenance.

While the expected service life of a well will depend on its design, construction, development and operation, proper maintenance will help to improve its performance and eventually increase its life span. As regards to O&M of drilled wells, HCFs should undertake the following actions:

- (i) Keep proper records of power consumption, well discharge and drawdown operating hours
- (ii) Carry out periodic chemical and bacteriological analysis of water and treating it when necessary
- (iii) Check well cap and the area if they are secured annually to avoid source contamination
- (iv) Make site free from hazardous waste, health care waste and other waste that can alter water quality
- (v) Undertake periodic cleaning of screens by adding hydrochloric, polyphosphates, specific proprietary chemicals or chlorine followed by agitation of the water in the well.

Also, preventive and routine maintenance should be done for protected shallow wells. On one hand, preventive maintenance should focus on cleaning of the surroundings and regular check-up of a hand pump/well at fixed time intervals e.g. weekly or monthly so as to change some parts before they are fully worn out. On the other hand, routine maintenance should involve replacing fast-wearing parts such as ring, I-seal, bobbins and bearings as shown in Figure 5.3.



**Figure 5.3: Routine maintenance of a protected shallow well fitted in hand pump**

#### 5.3.4 Taping Springs

Some HCFs may opt to use water from nearby protected springs. A land spring is a simple outcropping of water that has percolated into permeable sub-soil and followed the first impermeable stratum to a point at which it reaches the surface.

Types of construction to be adopted are different due to spring type, size and location. Drain system and storage chambers should be constructed in such a way that it prevents contamination of the collected water. The main parts of a spring water collection system are as listed below should be observed during construction.



### Main parts of spring water collection system

- *A drain under the lowest natural water level*
- *An outlet to tank or collection point*
- *An outflow pipe just below the roof*
- *A protective structure providing stability*
- *A seal to protect surface water from leaking back into stored water.*

### 5.3.5 Operation and maintenance of springs

Spring capping requires minimum interventions in operation and maintenance. Thus, generally the main O&M activities will include:

- (i) Permitting water to flow out freely from the chamber at all times so that it will not find another way out through the aquifer in different direction.
- (ii) Opening or closing the valves to divert water to reservoir or a drain
- (iii) Maintaining cleanliness of the spring and its surroundings

In addition contamination and deterioration of water should be avoided by checking the following anticipated issues at regular intervals:

- (i) Check surface drains
- (ii) Fence the spring and regularly check and repair animal-proof fence and gate
- (iii) Protect the vegetation cover growth within the spring and the surrounding area
- (iv) Check frequently the water flow from the spring box in order to detect water turbidity or increased flow after rain storm. In case of surface rain-off protection of the spring should be improved. Whereas, if the system is clogged gravel should be replaced by new ones.
- (v) Take regular water samples as recommended by guideline to check for evidence of fecal contamination
- (vi) Open the washout annually to remove the accumulated silt
- (vii) Check screens regularly. If they are found damaged or blocked they should be cleaned or replaced with non rusting materials.
- (viii) After cleaning, make sure the washout valve is fully closed and manhole cover sealed
- (ix) Disinfect the spring box each time a person enters to clean or repair or when there is bacteriological contamination
- (x) Repair any leaks in the protective seal, undermining of the head wall, or damage caused by erosion or settlement of soil must be repaired

HCFs which use water from springs should adopt the O&M schedule in Table 5.2.

**Table 5.2: Routine maintenance of springs**

S/N	Activity	Frequency	Materials and parts	Tools and equipment
1	Clean surroundings	Weekly		Broom, bucket, hoe, machete
2	Check the water quantity	Occasionally		Bucket, watch
3	Repair fence and clean drain	Occasionally	wood, rope, wire	Machete, axe, knife, hoe, spade, pickaxes
4	Check the water quality	Regularly	laboratory reagents	laboratory equipment
5	Wash and disinfect the spring	Annually	Chlorine	Bucket, wrench, brush
6	Repair piping and valves	Occasionally	Spare pipes and valves, cement, sand, gravel	Bucket, trowel, wrench, flat spanner
7	Repair cracks	Annually	Cement, sand, gravel, clay	Bucket, trowel, hoe, spade, wheelbarrow
8	Check turbidity	After every flood	Standard turbidity reagent, turbidity columns, brush, test tube, pipe, rod and plastic stirring	Turbidity kit

### 5.3.6 Installation of rain water harvesting systems

Rain water harvesting is a common alternative source that can ensure availability of water in HCFs, especially in areas with water scarcity or intermittent water supply. The capacity of harvesting RWH system depends on the quality of collecting surface (roof), storage capacity and the rainfall seasons. Because rainwater is 'soft water' it has many advantages for use in HCFs. It can be used for cleaning, drinking, sterilization and washing. As often as possible water from RWH system should be used for drinking purposes especially when the local water supply sources dry up for some periods in a year or where rainfall is unreliable. However, in areas where there is reliable and uniform pattern of rainfall RWH can be used as the sole water source for all uses in a health facility. Therefore, it is necessary for each HCF to install a RWH system especially as a backup source of water to augment the water demand during dry season.

#### 5.3.6.1 Minimum specifications for RWH systems in health care facilities

- (i) **Roofing requirements:** Roofs suitable for water collection in HCFs include: unpainted zinc/aluminium-coated or galvanized steel, factory-coated or painted zinc/aluminium alloy-coated or galvanized steel, stainless steel, aluminum sheet and concrete or terra cotta (clay) tiles.

#### Caution!

*Rainwater should not be collected from roof catchments with asbestos materials or locally painted iron sheets mainly due to their adverse health effects.*

- (ii) **Conveyance requirements:** Conveyance system usually consists of gutters and drain pipes that deliver rainwater from the catchment area into the storage tanks. The conveyance systems should be of inert material to avoid negative effects on water quality. Hence, gutters should be securely fitted on strong and well aligned fascia board and should have adequate slope to efficiently convey all the water to the storage tank. For efficient guttering, the length of each segment of gutters (with one outlet) should be limited to 15m in order to allow for provision of adequate slope as well as reducing water loss/spillage during heavy rains. As a matter of practice, gutters should not be handled more than 15cm below the roof. Recommended materials for gutters and downspouts are PVCs, vinyl pipes, seamless aluminum and galvanized steel (Krishna, 2005).

- (iii) Storage Requirements:** The rainwater ultimately is stored in a storage tank, which should also be constructed of inert material. The recommended materials for construction of storage tanks are reinforced concrete, Ferro-cement, bricks/blocks, fiberglass, polyethylene, or stainless steel. The storage tank can either be constructed over ground or underground as long as it is tight and solid with secure cover to avoid risks from pollution sources or damage by erosion. In addition water should be taken from the storage tank by tapping or pumping. Use of bucket and rope are strongly discouraged as these methods are unhygienic. Other important factors which should be considered in designing a storage tank include:
- (i) It must be of adequate capacity to meet the water demand for the HCF. If there are several separate buildings in the HCF more storage tanks will be required – one for each building.
  - (ii) It should have a provision of a sloped bottom and provision for collection of settled grit and sediment
  - (iii) It should have a manhole for easy access for cleaning
  - (iv) It should have a vent for air circulation (often the overflow pipe)
  - (v) It should not have excessive lose through seepage or evaporation
  - (vi) It should be covered to prevent entry of light, and sealed against intrusion by mosquitoes and other small creatures
  - (vii) It should be ventilated to prevent anaerobic decomposition of any washed matter
  - (viii) It should be sited as close to the building as possible without undermining its foundation in order to reduce guttering costs and complications.
  - (ix) If an underground design is used it should be more than 15 meters away from any pit toilet, soak away pit and septic tanks.



**Figure 5.4: Rain water harvesting with first -flush tank**

- (iv) Selection of tank size:** The size of a tank will depend on the following factors:
- (i) The amount and distribution of rainfall as these vary from one area to another;
  - (ii) The size of the (roof) catchment area meaning that HCFs with many buildings will need to opt for larger sizes of tanks;
  - (iii) Intended level of service;
  - (iv) The desired daily water demand; and

- (v) Cost implications which will vary depending on location, type of materials to be used and level of implementation

- (v) **Amount of water for harvesting:** The amount of rainwater that can be harvested from roof top for different rainfall amount and roof size is calculated as:

$$S = K \times I \times A$$

**Where:**

S = Yield in m<sup>3</sup> / annum

A = Area of catchments, m<sup>2</sup>

I = Average annual rainfall m/annum

K = runoff coefficient (0.8 to 0.9 for roof tiles and 0.7 to 0.9 for corrugated sheets)

The amount of water storage in the HCFs will depend highly in the provision of the storage capacity available. The storage facility can be underground reservoir or elevated tanks of different types.

- (vi) **Installation of First Flush System:** The First Flush System (FFS) also called a Foul Flush Device (FFD) is a device to ensure that the first water from each shower, which is in fact mostly contaminated with dust, leaves, insects and bird droppings is diverted from clear water container such as a storage tank of at least 500 litres or concrete tank. A wash out or delivery pipe should be fitted on the FFS tank to continuously draw out the dirty water stored for non-potable use. The water in FFS tank can be used for watering gardens. In case the HCF has more than one storage tank, the FFS should be installed for each storage tank. This ensures rain water harvested into storage tank is potable.
- (vii) **Water abstraction point:** Water abstraction point should be securely lockable and yet able to provide easy access for fetching water and to minimize water spillage. Spilled water should be disposed of in soak away pit or collected for watering gardens. Installation for convenient access will depend on the level at which the tank is set which in turn depends on the height of the catchment roof.



**Figure 5.5: Water abstraction point at a dispensary**



### 5.3.6.2 O&M for rooftop rainwater harvesting system

Rooftop rainwater harvesting system requires minimal attention with respect to their operation. The major concern is to prevent the entry of contaminants into the tank while it is being replenished during a rainstorm. The main causes of bacterial pollution are from debris, bird and animal droppings, and insects that enter the tank.

The following maintenance guidelines should be considered in the operation of rooftop rainwater harvesting system:

- (i) Flush the rainwater to waste and away from the tank to avoid the entry of debris from the catchment area into the tank.
- (ii) Check and clean the storage tank periodically.
- (iii) Cover and ventilate the tank to avoid mosquito breeding, prevent insects and rodents from entering the tank, and minimize the growth of algae.
- (iv) Chlorinate water in storage tanks.
- (v) Maintain gutters and down pipes. A good time to inspect gutters and down pipes is while it is raining, so that leaks can easily be detected. Regular cleaning is necessary to avoid contamination.
- (vi) If filter is provided, it should be cleaned every month and/or when it is required, filter sand should be washed at least every six months.
- (vii) Leaks have to be repaired throughout the year, especially leaking tanks and taps, as they present health risks.
- (viii) In some cases, where the water is pumped, periodic, preventive maintenance is required on the small pumps that lift water to selected areas of house or building, or provide public supply from underground storage tanks.

**Table 5.3: Main activities involved and frequency of maintenance of a RWH system**

S/N	Activity	Frequency	Materials and Spare Parts	Tool and Equipment
1	Clean the system	1-3 times per year	Chlorine	Broom, brush, bucket
2	Divert foul flush	Every storm	-	-
3	Clean the filters	Twice a year	Sand, charcoal, plastic, mesh	-
4	Disinfect reservoir	Occasionally	Chlorine	Bucket, gloves, respirator, gum boots, overall clothing
5	Repair roof, gutters and piping	Occasionally	Tiles, metal sheet, asbestos, cement, sheet etc. Bamboo or PVC piles, wire	Hammer, saw, pliers, tin cutter
6	Repair tap or pump	Occasionally	Washers, cup seals etc.	Spanner, screw driver
7	Repair reservoir	Occasionally	Cement, sand, gravels and bricks	Trowel, spade, bucket

### 5.4 Water sources protection

It should be noted that protection of water sources from pollution/ contamination is better than treating it after it has been contaminated. Various water sources can be protected as described in Table 5.4.

**Table 5.4: Water source protection**

Water source	Source Protection
Ground water (well)	<p><i>Casing:</i> the inside wall of the well should be made water proof by cementing from the top of the well down to a minimum depth of 3 meters. The deeper it is extended, the better. The casing of the well should also be extended for a minimum of 60cm above the surrounding ground level.</p> <p><i>Cover:</i> A concrete cover should be fitted over the casing to prevent dust, insects, small animals, etc from falling in to the well and also to prevent leakage of flushed water.</p> <p><i>Sanitary water drawing device:</i> Ideally, a pump should be installed, but if a pump is not available a sanitary bucket and rope system should be used</p> <p><i>Fencing:</i> The immediate area of the well should preferably be fenced to keep animals away.</p> <p><i>Diversion ditch:</i> The area surrounding the well should be graded off in order to prevent the flow of storm water into the well.</p> <p><i>Cleanliness:</i> The area surrounding the source should be maintained clean</p>
Rain water harvesting (RWH)	<p>Flush the rain water to waste and away from the tank to avoid entry debris from the catchment area into the tank.</p> <p>Check and clean the storage tank periodically</p> <p>Cover and ventilate the tank to avoid mosquito breeding, prevent insects and rodents from entering the tank and minimize the growth of algae</p> <p>Provide filter to tank and clean monthly</p>

### 5.5 Minimum water requirements for health care facilities

Water demand in HCFs refers to the total amount of water to be used by the HCWs, patients and carers in a specific time. Hence, water requirements will vary from one HCF to another depending on the average number of people being served in a particular time, number and type of tasks carried out in different units and the level of the health facility. Water in HCFs is primarily required for domestic use, medical procedures, sanitation and hygiene use. Water requirements in HCFs in terms of litres per person or bed per day will vary depending on the level of the facility. For example, in dispensaries water consumption per day will be lowest compared to health centers, district, regional and national/referral hospitals. Thus, the higher the level of the facility, the more the quantity of water required because of the number of users and types of uses.

#### NOTE:

*Regardless of the level of the facility, water in HCFs must be available at all times with adequate quantity and quality for different uses as per facility needs to maintain effective functioning of the facility.*

Table 5.5 provides the national minimum water requirements for different levels of HCFs in both urban and rural areas and these should as much as possible be maintained.

**Table 5.5: National water requirements for health care facilities**

HCF Level	Unit	Rural L/D	Urban L/D	Remarks
Dispensaries	l/Visitor/day	10	10	Out patients only
Health center	l/bed/day	50	50	No modern facilities
Health center	l/bed/day	100	100	With WC and sewer
Hospitals, District	l/bed/day	-	200	With WC and sewer
Hospitals: Regional/National	l/bed/day	-	400	With surgery unit
Administration offices	l/Worker	10	-	With pit latrine
			70	With WC

Source: (MoWI (2009): *Design Manual for Water Supply and Wastewater Disposal*).

In addition to the overall national water requirements in HCFs as presented in Table 5.5 above, Table 5.6 and Table 5.7 provide specific recommendations of water requirements for patients, visitors and staff respectively.

**Table 5.6: Water requirements for patients and visitors in health care facilities**

Health Care Facility	Visitors/ Outpatient	Inpatient	Total No of Patients	Litre/day/cap	Total Litres/day/ HCF
Dispensary	70	0	70	10	700
Health Centre	60	24	84	100	8,400
District Hospital	170	175	345	200	69,000
Regional Referral Hospital	500	450	950	400	380,000
National /zonal and specialized Hospitals	800	1000	1800	400	720,000

**Table 5.7: Water requirements for staff in health care facilities**

Health Care Facility	Number of staff	Litre/day/cap	Total Litres/day/HCF
Dispensary	13	10	130
Health Centre	45	70	3,150
District Hospital	198	70	13,860
Regional Referral Hospital	680	70	47,600
National /zonal and specialized Hospitals	1634	70	114,380

## 5.6 Water storage

### 5.6.1 Minimum water storage requirements for HCFs

Water storage requirement for HCFs is determined by water demand of the each facility's level of service and time required to carry out its activities during non supply of water from the source. Water should be stored in HCFs for the following reasons:

- (i) To guarantee a consistent water supply during intermittent/rational situations
- (ii) To increase the volume and pressure during scarcity of water, as long as the tanks are correctly installed and work with the adequate plumbing



**NOTE:**

*Every HCF should have the ability to supply water from storage tanks for at least 72 hours in case the main source is not functional.*

The estimates of water storage requirements for different levels of HCFs are as given in Table 5.8. It is therefore recommended that each HCF should as much as possible ensure that its water storage remains within those estimates.

**Table 5.8: Water storage requirements for patients and staff in health care facilities**

Health Care Facility	Total Litres/day/HCF
Dispensary	830
Health centre	11,550
District hospital	82,860
Regional referral hospital	427,600
National /zonal and specialized hospitals	834,380

### 5.6.2 Cleaning and disinfection of water storage tanks

It is of practical importance for HCFs to clean and disinfect water storage tank(s) at least once after every three months. Cleaning and disinfecting water storage tanks aims at removing algae (plant growth which produces bad tastes and odours), silt, and bacteria which may be harmful.

The steps below should be followed in cleaning and disinfecting water storage tanks:

- (i) Empty the tank
- (ii) Scrub or pressure wash the interior walls to remove dirt and grime with detergents
- (iii) Rinse out the tank
- (iv) Scrub or pressure wash the interior walls of the tank with 0.2% chlorine solution, and leave for 2 hours.
- (v) After 2 hours, thoroughly rinse the tank with clean water Refill tank with water.



**Figure 5.6: A sketch of water storage tank cleaning**

**REMEMBER!**

*Water storage tanks should be cleaned once every three months or more frequently if necessary.  
Every PVC tank should be provided with washing and flushing outlet.*

**5.7 Water quality**

For the purpose of these guidelines water quality refers to water free from chemical, physical, biological, and faecal substances, and fit for domestic and medical uses.

**5.7.1 Water quality standards for health care facilities**

Water supplied in HCFs should maintain a standard quality to ensure that there is total absence of risks from microbiological, chemical and physical contaminants. Thus, all water supplied in HCFs for whatever use should meet the following recommended standards.

**Table 5.9: Water quality standards for health care facilities**

Location	Parameter	Standard/ Target	Means of Verification
Groundwater source	Faecal contamination	0 fcu/100ml	Water sampling at point of abstraction
	pH	6.5 – 9.2	
	Turbidity	<5 NTU	
	Arsenic	0.05 mg/L	
	Fluoride	1.5-4.0mg/L	
	Iron	0.3-1 mg/L	
	Manganese	0.1-0.5 mg/L	
	TDS*	1000 mg/L	
	Total Filterable Residue	500-2000 mg/L	
	Total Hardness (CaCO <sub>3</sub> )	500-600 mg/L	
	Calcium Ca	75-300 mg/L	
	Magnesium Mg	50-100 mg/L	
Surface water source	Nitrate (NO <sub>3</sub> )	10-75 mg/L	Water sampling at point of abstraction
	Faecal contamination	0 fcu/100ml	
	pH	6.5 – 9.2	
	Turbidity	<5 NTU	
	TDS*	1000 mg/L	
	Colour	1.5-50 TCU	
Piped mains water	Faecal contamination	0 fcu/100ml	Water sampling at point of entry
	Free chlorine residual	0.5-1 mg/L	
	pH	6.5 – 9.2	
	Turbidity	<5 NTU	
Water collection points	Faecal contamination	0 fcu/100ml	Random selection of 4 water collection points
	Free chlorine residual	0.5-1mg/L	
	Turbidity	< 5 NTU	
	Flow*	0.33 l/s	

**Source:** *The Environmental Management (Water Quality Standards) Regulations, 2007*

\*Adopted standard from WHO

## 5.8 Water treatment

### 5.8.1 Disinfection

Disinfection with chlorine is the most widely accepted and appropriate way of providing microbial safety in most of the HCFs in Tanzania. Bleaching powder, liquid bleach, chlorine tablets and other sources of chlorine may be used, depending on local availability.

To ensure adequate disinfection, a contact time of at least 30 minutes should be allowed between the moment the chlorine is added to the water and the moment the water is available for consumption or use. The free chlorine residual (the free form of chlorine remaining in the water) after the contact time should be between 0.5 and 1.0 mg/L in all points of the system, including end-points. Residual chlorine can be measured with simple equipment such as a colour comparator and diethyl-p-phenylenediamine tablets.

Effective disinfection requires that the water has a low turbidity. Ideally, median turbidity should be below 5 NTU (URT, 2007). If turbidity exceeds 5 NTU then the water should be treated to remove suspended matter before disinfection, by sedimentation (with or without coagulation and flocculation) and/or filtration.

#### REMINDER!

*HCFs should carry out water quality analysis for physical, chemical and bacteriological composition before use of a new source of water.*

## 5.9 Water access and distribution

Water access refers to the availability of water within a reasonable distance to allow convenience of access and use. Access will be determined by distribution of water taps or water points within the HCF. The purpose is to ensure that sufficient water-collection points and water-use facilities are available in the HCF to allow convenient access to, and use of, water for medical purposes, drinking, personal hygiene, food preparation, laundry and cleaning. As a guiding principle, water should be available within all wards and in waiting areas.

### 5.9.1 Major considerations in the distribution of water in health care facilities

Water points/taps in HCFs should be installed taking into account the following aspects:

- (i) A reliable drinking-water point should be accessible for staff, patients and carers at all times.
- (ii) A reliable water point, with soap or a suitable antiseptic or sanitizers, should be available at all critical points within the HCF including operating theatres, wards, consulting rooms, dressing rooms, etc. and in service areas such as sterilization, laboratory, kitchen, laundry, showers, toilets, waste zone and mortuary.
- (iii) At least two hand washing basins should be provided in wards with more than 20 beds
- (iv) At least one shower should be available for 40 users in inpatient settings (users include patients, HCWs and carers).
- (v) Laundry facilities, with soap or detergent, hot water and a disinfectant (such as chlorine solution) should be available for inpatient settings.

#### REMEMBER!

*Disinfection can eliminate or reduce pathogens however it will not correct water problems caused by chemical contamination like heavy metals.*

## CHAPTER SIX

### 6.0 SANITATION IN HEALTH CARE FACILITIES

#### 6.1 Introduction

In the context of these guidelines, sanitation includes construction and/or rehabilitation and management of sanitation facilities in HCFs, and maintenance of hygienic conditions through services such as garbage collection and waste water disposal. It entails management of night soil (excreta), waste from ablution fittings, storm water, health care wastes (including placenta), and environmental cleanliness.

The main purpose of having improved sanitation facilities is to prevent diseases by breaking pathogen transmission pathway or disease-causing organisms found in human excreta and waste-water from entering the environment and posing a threat to people's health. Thus, adequate, safe and appropriate sanitation facilities/services will serve to prevent infections and minimize spread of diseases within the HCFs, by protecting staff and patients, and maintaining the dignity of vulnerable people including pregnant women, the seriously sick patients and people with physical disabilities.

This chapter provides guidelines for sanitation services in HCFs. The guidelines consist of planning for sanitation interventions in HCFs, recommended sanitation options for different levels of health facility settings, minimum standards of technical designs and specifications for sanitation facilities for able-bodied, disabled or other people with special needs.

#### 6.2 General adequacy criteria for excreta disposal facilities in health care facilities

Generally, sanitation services in HCFs will be satisfactory and adequate if the following minimum requirements are met.

##### 6.2.1 User convenience

There should be separate provisions of toilets for female and male users for HCWs, visitors, patients and people with special needs such as the physically disabled, pregnant women, elderly, seriously sick persons, and young children. Supportive amenities should be provided for people with special needs such as wheel chair users and the blind. Sign posts indicating toilets for male and female users should be provided to help them find the toilets easily. Also, toilets should be designed and equipped to respond to social and cultural norms such as provision of water for anal cleansing, lockable doors for privacy and a clear access pathway usually lit during the night.

##### 6.2.2 Accessibility

Toilets should be conveniently located; preferably not more than 30 metres from all users so that they can be easily reached and free from any forms of obstruction (physical or non-physical) that is toilets must be open for use when needed.

##### 6.2.3 Reliability

Toilets should at all times be in good state of repair and functional.

##### 6.2.4 Safety

Sanitation facilities should contribute in minimizing infections within the HCFs instead of being routes of transmission of infections. Sanitary and waste disposal facilities should be designed and constructed in such a way that the sanitary waste or human excreta do not contaminate the environment or transmit harmful agents such as microbial, physical contaminants, or harbour vector or vermin. Similarly, measures to control fly and mosquito breeding should be in place especially for toilets. Sanitary facilities should be

structurally sound without presenting the risk of collapsing, falling, or otherwise causing injuries to users. In order to minimize the risk of violence, including sexual violence, toilets should be properly located, with lockable doors and access should be lit at night (WHO, 2008)

### 6.3 Recommended public toilet for health care facilities

Due to public health concerns in HCFs the flush toilets either pedestal or squatting type should be provided. In other words, each HCF should aim for the water based sanitation systems. However, due to serious water availability constraints in most of the rural areas in Tanzania, it is recommended that a VIP latrine option can be used. Various types of water based toilets recommended for use in HCFs are presented in Figure 6.1.

**Pedestal flush toilet**



**Squat flush toilet**





**Figure 6.1: Types of toilets recommended in health care facilities**

## 6.4 Designing and construction of sanitation facilities

### 6.4.1 General considerations

Providing adequate sanitation infrastructure and services requires careful planning and selection of appropriate designs for a facility. Designing of sanitation facilities should be part of the initial HCF planning. However, where sanitation infrastructure and services are inadequate it is equally important to plan for construction of new ones or upgrading the existing facilities. As mentioned in the preceding section, three types of toilets are recommended for HCFs depending on the following factors:

- (i) Facility size and catchment population (with future projections)
- (ii) Type of services being offered at a facility
- (iii) Availability of reliable water supply
- (iv) Level of water table



- (v) Soil permeability to determine the depth of pit to be excavated and the possibility of contamination of ground water source
- (vi) Presence of supporting sanitation infrastructure such as a public sewer
- (vii) Socio-cultural norms of users
- (viii) Cost of the sanitation infrastructure
- (ix) Any other environmental technical and social considerations that might apply

These guidelines assume that all district, regional, zonal and national hospitals including specialized/consultant hospitals have flush toilets though their current conditions and sufficiency vary from one HCF to another. Hence, depending on the current condition of the existing toilets each HCF at these levels will have to consider either rehabilitating the old ones, increasing the number of flush toilets as per demand or both.

## 6.4.2 Flush toilets

Flush toilets can be designed for sitting or pedestal but both designs do not handle waste on site as their drain pipes are connected to waste conveyance and waste treatment systems. Once the content is flushed the wastewater flows into a septic tank or sewage system and from there to a sewage treatment plant. The choice between western and eastern flush toilets will depend on the number of users as well as the socio-cultural aspects. For various socio-cultural and even hygiene reasons many public places such as institutions prefer the squatting type especially if there many users.

### 6.4.2.1 Structural components of a flush toilet

- (i) **Technical requirements:** Water flushed toilets require a bowl or pan, (into which excreta are deposited) and a water seal created by placing a ‘U’ bend beneath the bowl. The bowl and ‘U’ bend can be integral or can be manufactured separately. The bowl may be designed to allow the user to squat or to sit, according to local customs. Most ‘commercial’ toilets are manufactured from ceramic or strong plastic materials. Some low-cost designs use cement mortar. Faeces will tend to hang to the sides of cement mortar bowls unless they have a very smooth ‘mosaic’ finish. Conventional toilets use a 50 mm deep water seal. To reduce the amount of flush water required, some designs reduce this to around 25mm.
- (ii) **Options for wastewater disposal:** Wastewater from water-flushed toilets may be discharged either in a septic tank, soak away, or to a public sewer which carries it away from the plot.
- (iii) **Water usage:** The bowl drain is visible at the rear of the bowl, connected to the waste pipe. The amount of water used by conventional flush toilets usually makes up a significant portion of personal daily water usage in HCFs especially those with relatively high numbers of HCWs, patients and carers. It could be as much as 50 litres per person per day if a person flushes the toilet five times per day with 10 litres per flush. It is recommended that HCFs should opt for modern low flush toilet designs, which allow the use of much less water per flush that range from 4.5 to 6 litres per flush.

### 6.4.2.2 Maintenance and hygiene of flush toilets

Flush toilets are not typically designed to handle waste on site. Instead, their drain pipes are connected to waste conveyance and waste treatment systems. In normal circumstances, when a toilet is flushed, the wastewater flows into an inspection chamber, septic tank then to a sewerage system or a soak away pit. For maintenance and hygiene purposes the following practices are recommended:

- (i) Users of flush toilets should be reminded through a visibly displayed poster that they must flush and leave the toilet clean after use.
- (ii) The cleaners should clean the flush toilet with a toilet brush and detergents.
- (iii) There should be a cleaning schedule that shows the cleaning time and a supervisor’s verification column that is signed to indicate monitoring for cleanliness.



- (iv) Periodic checks on effective functioning of the flush toilets in the HCF should be carried out to identify any mechanical faults especially the blockage of wastewater flow due to the faulty cistern mechanism.
- (v) Since in many cases flush toilets are located within the buildings, rectification of such faults should be done immediately otherwise flies could be easily attracted within the premises of the HCFs. Rectification is also important to avoid bad smell from blocked toilets.
- (vi) Bed pans should be immediately cleaned and disinfected after being used by the patients.

### 6.4.3 Ventilated Improved Pit Latrines

#### 6.4.3.1 General features of a VIP latrine

A ventilated improved pit latrine (VIP) as shown in Figure 6.1 is the advancement from an improved traditional pit latrine aimed at controlling foul smell and release of vectors flies from the latrine. A VIP latrine differs from a traditional pit latrine in that it has a tall vertical vent pipe which has a fly-screen fitted at its top. The vent pipe is responsible for both odour and fly control. Two types of VIP latrines are identified as the single-pit and double pit VIP latrine. The latter is designed to allow the removal of the pit contents at regular intervals of between two and three years. Hence, the second type provides a more permanent facility which is especially suitable for longer term uses. VIP latrines are suitable where the HCF has adequate land and there are no rocky and high water table areas.

The principal mechanism inducing ventilation in VIP latrines is the action of the wind blowing across the top of the vent pipe. The vent pipe controls flies in VIP latrines in two ways. Firstly, since flies are attracted to pit latrines by the faecal odour coming from them, almost all flies will try to enter the pit via the top of the vent pipe as that is the point from which the odour emerges; but they are prevented from entering by the fly screen.

Secondly, a few flies that may enter the pit via the superstructure and squat-hole and lay their eggs in the pit, the top vent screen will prevent them from leaving the pit holding and perish them. Thus, the screened vent pipe has three important functions namely, eliminating faecal odours in the superstructure, preventing most flies from entering the pit, and preventing the few flies bred in the pit from escaping.

#### 6.4.3.2 Structural components

Both single-pit and alternating double-pit VIP latrines consist of five basic structural components which are the pit, the cover slab and its foundation, the superstructure, and the screened vent pipe. A cross section of a VIP latrine is presented in Figure 6.2. However, minor differences exist in the design between the components for the single versus double pit types also, as shown in Figures 6.3 and 6.4.

For all VIP latrines a cover slab made of concrete floor is recommended. The slab should be appropriately provided with a drop hole located near an inner wall. In addition the floor should be provided with a hole for insertion of a vent pipe. The squatting plate should be cast using an appropriate mound for easy use and considering social cultural preferences in the area.

## Dry on-plot systems

### Ventilated Improved Pit (VIP) toilet

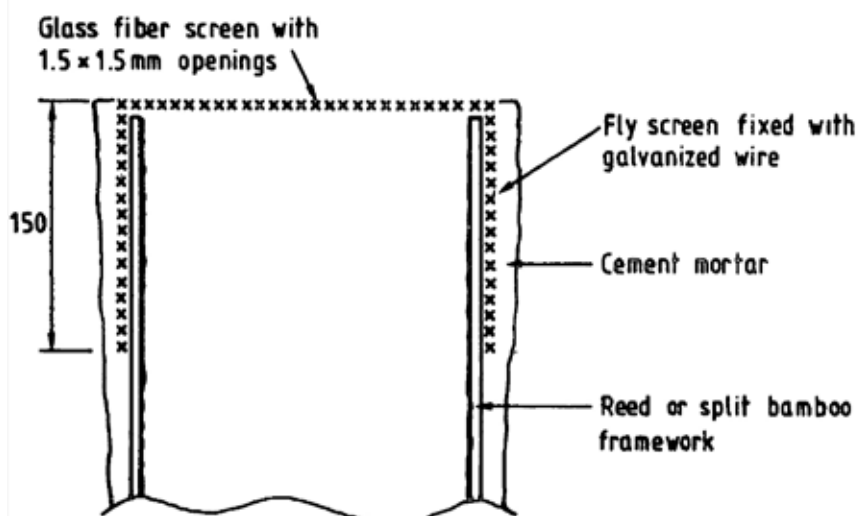
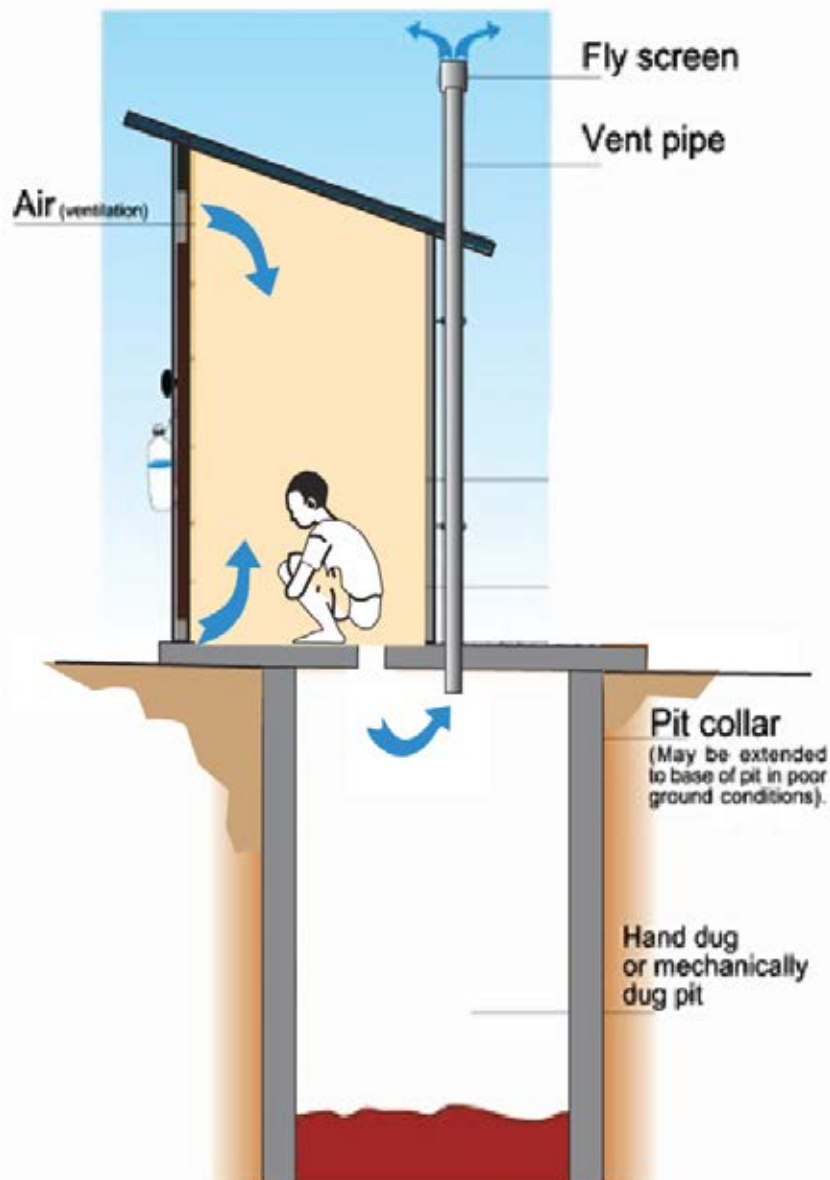
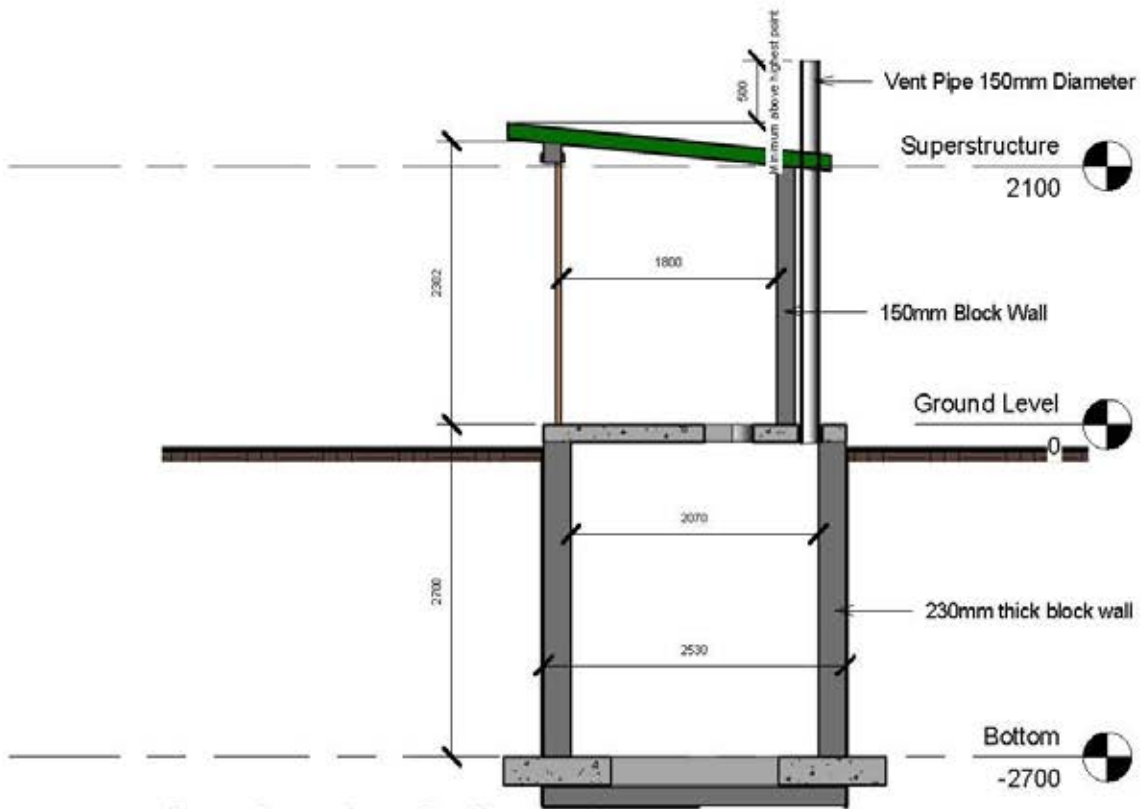
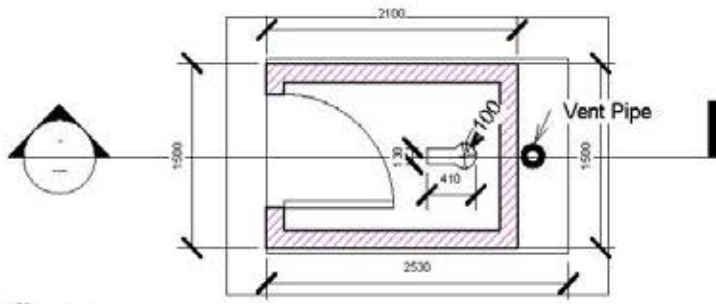

Figure 6.2: A cross-section part of a VIP latrine



1 Section 1 - Callout 1  
1 : 50



2 Top View  
1 : 50

Building Section Policy and Planning Department Ministry of Health, Community Development, Gender, Elderly and Children 6 Samora Machel Avenue P. O. Box 9083, Dar es Salaam Tel: +255 22 234000/5 Fax: +255 22 2137591	<b>MoHCDGEC</b> Guideline Design for VIP	<b>Details - Single Pit VIP</b>		
		Project number	0001	<b>A101</b>
		Date	Issue Date	
		Drawn by	MoHCDGEC	Scale
	Checked by	MoHCDGEC		

03/13/2017 12:17:41 PM

Figure 6.3: A cross- section part of single VIP latrine

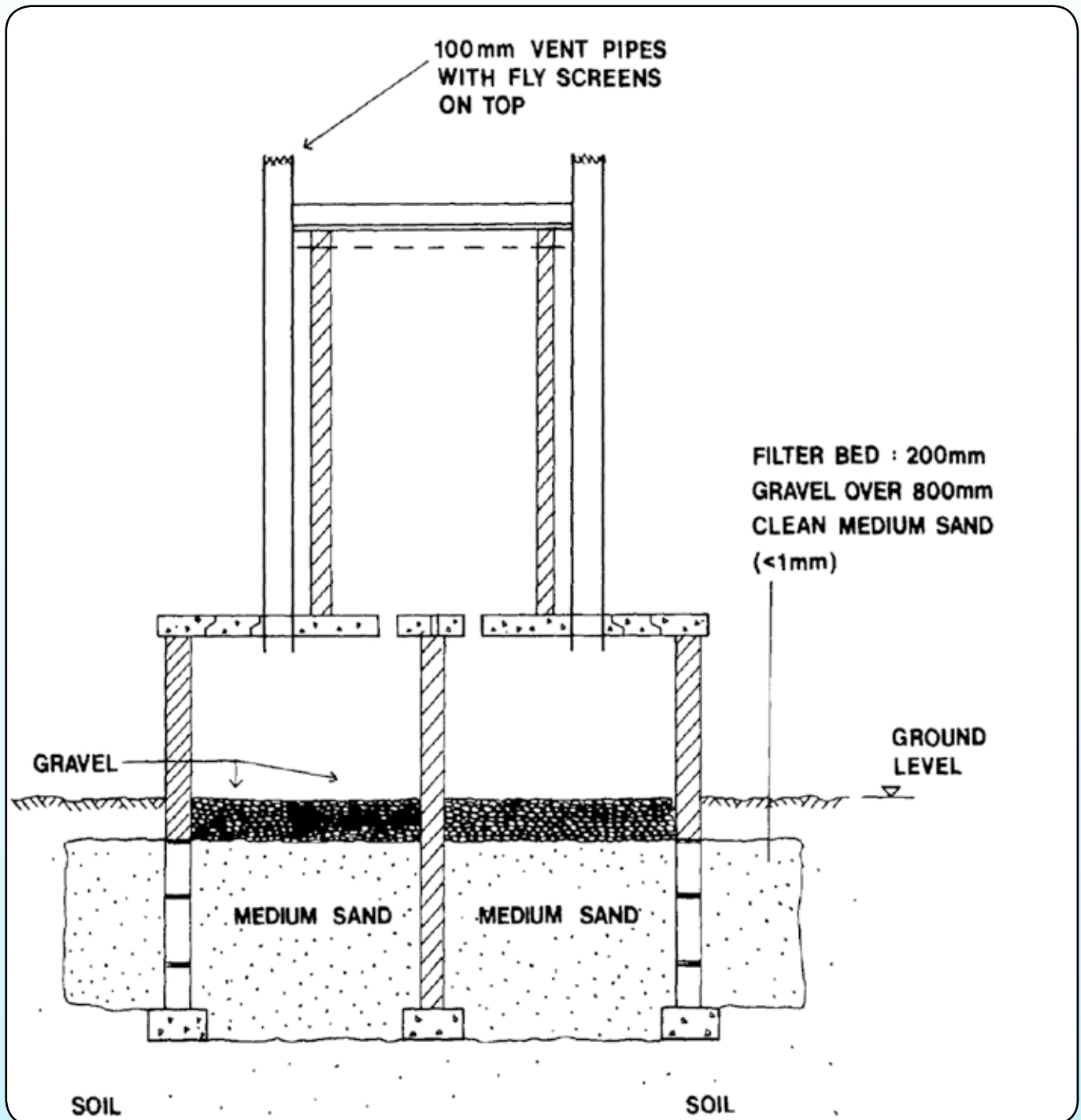

**Figure 6.4: A cross- section part of a double VIP latrine**

The VIP superstructure consists of walls and roofs. The walls should be made of durable materials, normally burnt bricks, cement blocks, or stones. The roof should be made of corrugated iron sheets or any other recommended durable roofing materials. The interior of the VIP in HCFs should be properly lined with wall and floor tiles for easy cleaning and maintenance. Hand washing and hand drying facilities including soap should be provided outside the latrine.

The vent pipe should be 27-200mm, preferably 110mm in diameter made from corrosion and sun-resistant materials commonly made of fibreglass and PVC. The vent pipe should extend for 0.8 above the roof level and covered with fly screen.

### 6.4.4 Toilet features for people with special needs



Public toilets can present accessibility challenges for people with special needs such as the physically disabled persons and even young children. HCFs are therefore required to have accessible toilets which are specifically designed to accommodate these groups of people according to their disability or special needs. There are various technical options of sanitation facilities from which HCFs can select the most appropriate ones suitable to their situations. Accessible toilets for people with disabilities are designed specifically to provide more space and bars for users to grab and hold during transfers (see Figure 6.5). There are also different designs of ramps as such as those illustrated in Figure 6.6, and it is up to the HCF to select which one is more suitable to serve the intended purpose.

Designs of sanitation facilities should essentially take into account the following categories of disabilities:

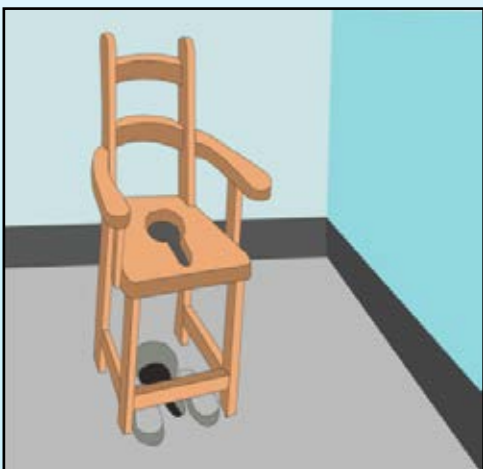
- (i) Blind people and people with poor vision need to have special grips and guiding systems (ramps) as well as proper lighting for the poor-sighted people.
- (ii) For people in wheelchairs or with crutches the design of a toilet should include wider doors, and special grips or foldable seats.

Technical Design	Functional purpose
	<p>To help the blind to access toilets by means of ramps</p>
	<p>A VIP toilet with a washable seat that provides comfort to people with physical disability especially those who cannot squat.</p>

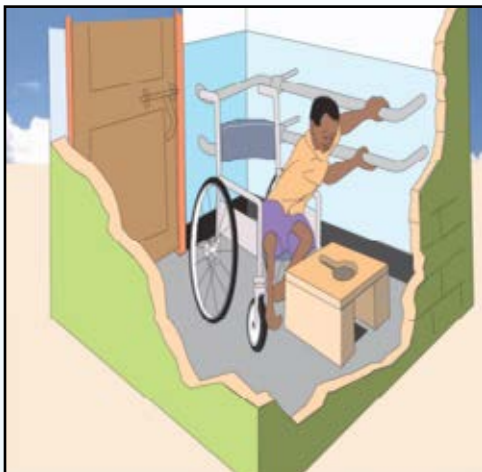

Technical Design	Functional purpose
	<p>Another design of a VIP toilet with a fixed wooden chair and bars to help disabled clients feel ease in accessing and using the toilet.</p>
	<p>A pedestal flush toilet for disabled and children who cannot use the squat toilets. Note also, that the hand washing facility is within reach of a user.</p>

**Figure 6.5: Designs of sanitation facilities for people with special needs**

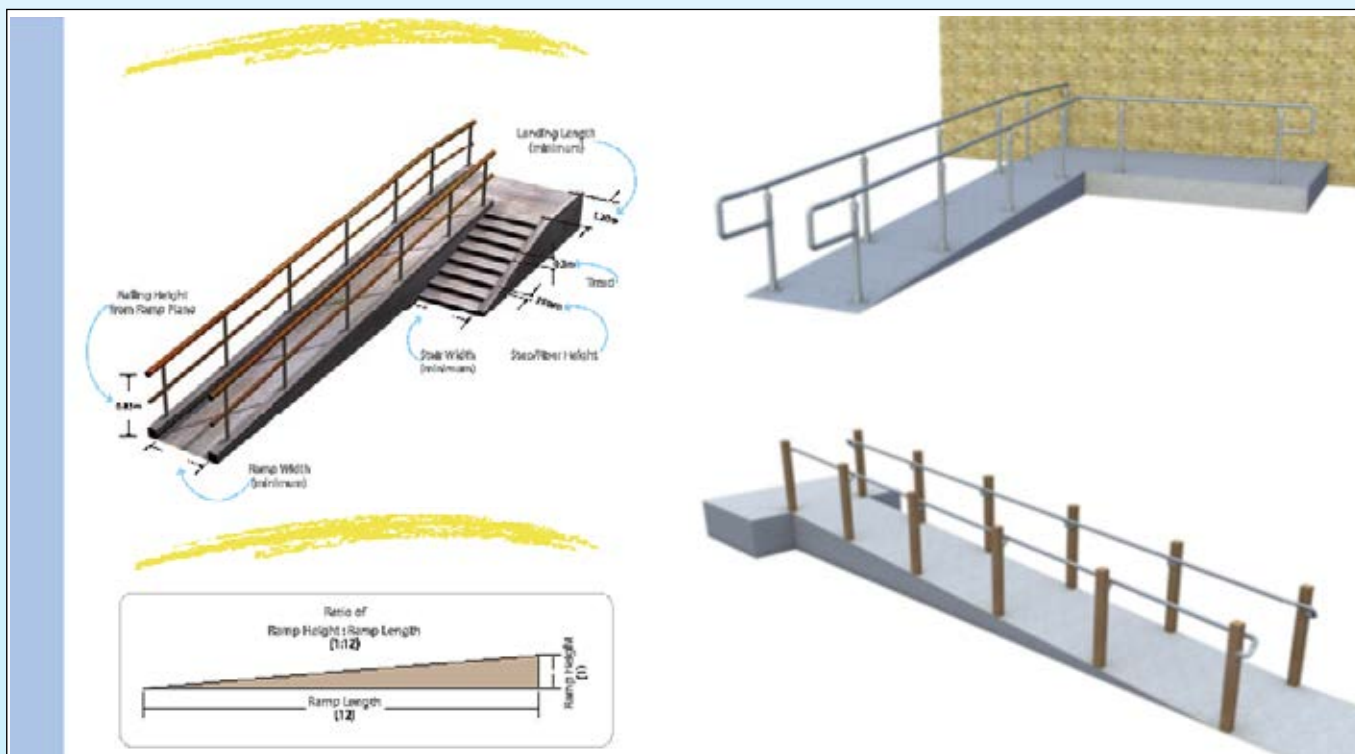
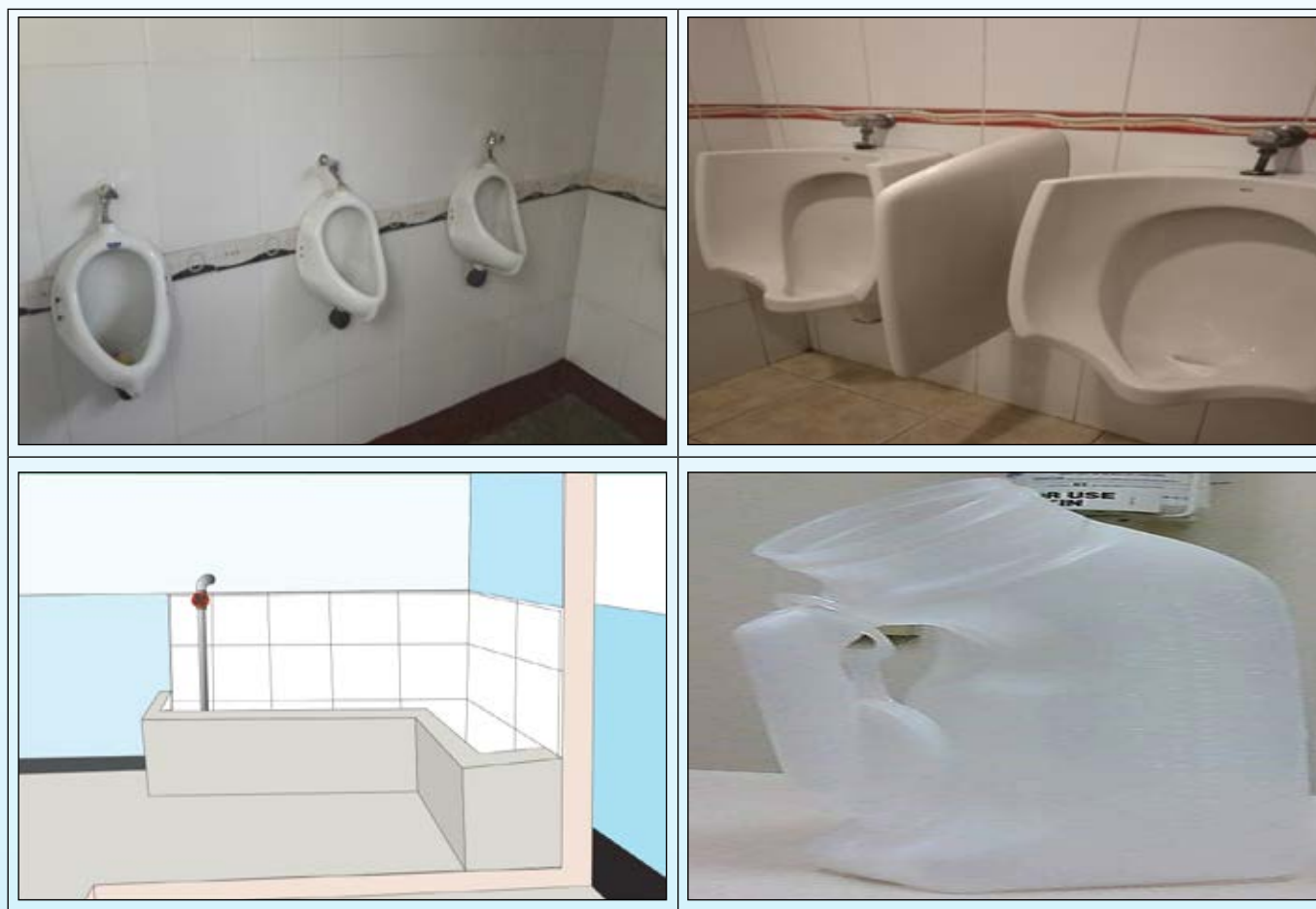

**Figure 6.6: Types of ramps for disabled persons**

## 6.4.5 Urinals

### 6.4.5.1 Urinals

A **urinal** is a sanitary plumbing fixture for urination used by men. It can take the form of a container or simply a wall, with drainage and automatic or manual flushing. Urinals must be seen as part of the package of sanitation facilities in HCFs. The construction of urinals reduces the number of toilets needed especially for male users and is cheaper to construct and maintain than toilets. Furthermore, the use of urinals might prevent the accidental fouling of the boy's toilets, which is in many cases the prime cause of unpleasant odours. The main types of urinals recommended in HCFs are as shown in Figure 6.7.



**Figure 6.7: Types of urinals**

### 6.4.5.2 Major features of a urinal

In constructing a urinal HCFs should take into account the following essential features:

- (i) It is possible for one urinal to include several urinal spaces
- (ii) A urinal space should at least be 0.6 meter of a urinal channel
- (iii) Urinals can be built as separate buildings or as part of a toilet block, i.e. using the back or sidewall of the toilets.
- (iv) There should be a raised footstep with a slope which separates the urine channel from the concrete floor
- (v) It is very important that a plastic or stainless steel trap is incorporated in the drain to prevent debris blocking the pipes.
- (vi) The compartment walls should be plastered and steel floated up to 1.2 meters above the floor. This should then be painted with a “urine” resistant washable paint.
- (vii) The urinals should be connected to a soak-pit.



**KEY POINTS ON URINALS:**

*Provision of urinals should consider the number and frequency of users, male children patients, appropriateness of urinal designs and availability of water, and maintenance arrangements.*

**6.5 Specific excreta disposal requirements for different levels of health care facilities**

Demand for sanitation services should be determined by the level of the facility. In accordance with the sanitation adequacy criteria outlined above, each level of HCF will have excreta disposal facilities (types and number) depending on the number of clients and staff and the services it provides as well as the existing infrastructures such as blocks and departments.

**Table 6.1: Recommended excreta disposal options for health care facilities**

Facility Level	Number and types of excreta disposal facilities
Dispensary	<ul style="list-style-type: none"> <li>(i) Two stances should be available for HCW (separate for male and female users)</li> <li>(ii) There should be one stance for every 25 users in OPD.</li> <li>(iii) There should be two stance for disabled people ( separate for male and female)</li> <li>(iv) One stance for children</li> <li>(v) Male toilets should include urinal units</li> <li>(vi) Additional toilet(s) may be provided next to delivery and Reproductive and Child Health Clinics (RCH) facility depending on the building layout and specific needs in an area</li> <li>(vii) Flush toilets with water seal are the recommended toilet options for dispensaries. However, VIP toilets may be provided in areas with critical water shortages.</li> <li>(viii) In all female toilets there should be a receptacle bin lidded and foot operated lined with a plastic bag for disposal of sanitary pads.</li> <li>(ix) Bath room for mothers after delivery</li> <li>(x) Placenta pit that meet the compost standard</li> </ul>
Health centres	<ul style="list-style-type: none"> <li>(i) There should be separate toilets for staff and clients in both OPD and IPD.</li> <li>(ii) At the OPD and reception area there should be at least 2 toilets for HCWs (separate for males and females) per department.</li> <li>(iii) At least one stance should be available for 20 users for IPD and one for 25 users at OPD</li> <li>(iv) At OPD there should be separate toilets for female and male clients and separate stance for male and female disabled clients and one for children.</li> <li>(v) Urinals should be provided in all male toilet blocks</li> <li>(vi) There should be a set of male and female toilets for HCWs in office blocks.</li> <li>(vii) Flush toilets, should be provided in all health centres with adequate water supplies.</li> <li>(viii) There must be flush toilets with water seal and bathing facilities at the deliver unit.</li> <li>(ix) Bed pans should be provided as per HCF requirements and should be separated between infectious and non-infectious wards.</li> <li>(x) Health centres must be provided with conventional sewage system onsite or offsite for effective liquid waste transportation and disposal.</li> <li>(xi) The final disposal of wastewater should be wastewater treatment ponds or any other recommended treatment methods. The sewerage systems must be properly maintained and monitored.</li> <li>(xii) In all female toilets there should be a receptacle bin lidded and foot operated lined with a plastic bag for disposal of sanitary pads.</li> <li>(xiii) Placenta pit that meet compost standards</li> </ul>

Facility Level	Number and types of excreta disposal facilities
District hospitals	<ul style="list-style-type: none"> <li>(i) There should be separate toilets for staff and clients in both OPD and IPD.</li> <li>(ii) At least one stance should be available for 20 users for IPD and one for 25 users at OPD</li> <li>(iii) At OPD there should be separate toilets for female and male clients and separate stance for male and female disabled clients and one for children.</li> <li>(iv) Urinals should be provided in all male toilet blocks</li> <li>(v) There should be a set of male and female toilets for HCWs in office blocks.</li> <li>(vi) Provision of sanitation facilities; one for people with disability and one for children should be considered in each of the facility's functional block or department.</li> <li>(vii) Actual number of toilets and urinals should be designed based on the average number of clients being attended.</li> <li>(viii) At least one toilet for each ward, service unit and a set of male and female toilets for HWCs in office blocks and reception areas should be provided.</li> <li>(ix) Excreta disposal facilities (including urinals) for hospitals must be water-based with flushing system and must adhere to high quality standards</li> <li>(x) No pit latrines (even improved) are allowed in a hospital setting.</li> <li>(xi) Bed pans should be provided as per hospital requirements and should be separated between infectious and non-infectious wards.</li> <li>(xii) Excreta disposal facilities for hospitals must be provided with sufficient water for regular operations and maintenance at all times.</li> <li>(xiii) Sufficient sewage system onsite or offsite (connected to public sewer) should be provided to support excreta disposal systems in accordance with the type of the sanitation infrastructure</li> <li>(xiv) Excreta disposal and bathing facilities should be provided specifically for delivery clients. Toilets at the delivery unit must be flush toilets with water seal.</li> <li>(xv) High temperature incinerator and Placenta pit with cover is recommended.</li> <li>(xvi) In all female toilets there should be a receptacle bin lidded and foot operated lined with a plastic bag for disposal of sanitary pads.</li> </ul>

Facility Level	Number and types of excreta disposal facilities
Regional referral hospital	<ul style="list-style-type: none"> <li>(i) There should be separate toilets for staff and clients.</li> <li>(ii) Two staff toilets (separate for males and females) per department. At least one stance should be available for 20 users for IPD and one for 25 users at OPD</li> <li>(iii) At OPD there should be separate toilets for female and male clients and separate stance for male and female disabled clients and one for children.</li> <li>(iv) Actual number of toilets and urinals should be designed based on the number of clients being attended.</li> <li>(v) At least one toilet for each ward, service unit and a set of male and female toilets for staff in office blocks and reception areas should be provided.</li> <li>(vi) Bed pans should be provided as per Hospital requirements and should be separated between infectious and non-infectious wards</li> <li>(vii) Adequate quantities of mobile receptacles (wheel chairs with receptacles) and bed pans should be allocated in each ward.</li> <li>(viii) Facilities for excreta disposal, waste water and solid waste management, and environmental cleanness for regional referral hospitals should adhere the minimum requirements as provided for hospitals level</li> <li>(ix) Excreta disposal and bathing facilities should be provided specifically for delivery clients. Toilets at the delivery unit must be flush toilets with water seal.</li> <li>(x) High temperature incinerator should be used.</li> <li>(xi) In all female toilets there should be a receptacle bin lidded and foot operated lined with a plastic bag for disposal of sanitary pads.</li> </ul>
National/zonal/specialized hospitals	<ul style="list-style-type: none"> <li>(i) There should be separate toilets for staff and clients in both OPD and IPD.</li> <li>(ii) Two staff toilets (separate for males and females) per department.</li> <li>(iii) At least one stance should be available for 20 users for IPD and one for 25 users at OPD</li> <li>(iv) At OPD there should be separate toilets for female and male clients and separate stance for male and female disabled clients and one for children.</li> <li>(v) At least one toilet for each ward, service unit and a set of male and female toilets for staff and clients in office blocks and clients reception areas should be provided.</li> <li>(vi) Bed pans as per the Hospital requirements and should be separated between infectious and non-infectious wards</li> <li>(vii) Adequate quantities of mobile receptacles (wheel chairs with receptacles) and bed pans should be allocated in each ward.</li> <li>(viii) Excreta disposal and bathing facilities should be provided specifically for delivery clients. Toilets at the delivery unit must be flush toilets with water seal.</li> <li>(ix) High temperature incinerator is recommended.</li> <li>(x) In all female toilets there should be a receptacle bin lidded and foot operated lined with a plastic bag for disposal of sanitary pads.</li> </ul>

**Note:**

- All OPD toilet must be open for all visitors/relatives
- Toilets should also be provided at waiting areas

## 6.6 Guidelines for waste and faecal sludge management

### 6.6.1 Importance of proper handling and disposal of wastes

Proper handling and disposal of contaminated and infectious wastes generated in the process of delivering medical services or using the toilets is essential in preventing infection and injury to patients, HCWs and carers or visitors at the HCF and the surrounding community. Contaminated and potentially infectious wastes found within HCFs include:

- (i) Faecal sludge from on-site sanitation
- (ii) Grey water produced from washbasins, showers, sinks and flushing toilets
- (iii) Body fluids and tissue specimens from patients
- (iv) Objects that have been in contact with body fluids or tissues, including intravenous catheters, wound dressings, gloves etc.
- (v) Sharp instruments such as scalpels and needles
- (vi) Microbiology specimens including liquid and plated cultures

### 6.6.2 Acceptable procedures in handling and disposal of wastes

The wastes mentioned above are regarded as potentially infectious as they are most likely to be in contact with pathogens. In order to ensure that such wastes are properly handled and disposed, HCFs should abide by the following acceptable procedures:

#### 6.6.2.1 Management of wastewater

For managing wastewater and faecal sludge, HCF should adhere to the following guidelines:

- (i) Treat wastewater from HCFs before final disposal. The treatment should be either onsite by using septic tanks and soakage pit or offsite by using waste water treatment ponds.
- (ii) Flush toilets should be connected to inspection chambers, septic tanks and soakage pit.
- (iii) For HCFs where the wastewater treatment plant is not available, contaminated liquids should be disinfected with chlorine before final disposal.
- (iv) Drainage systems should be installed for management of ablution waste for all Health Care delivery points, lavatories, sluice rooms, laundry, and at any other points where grey water is produced.
- (v) Ablution waste drains should be centralized or detached depending on the complexity of the facility infrastructure and the health and safety risks involved.
- (vi) Wastewater from hand washing points should be disposed in simple ground seepage systems.
- (vii) The wastewater from delivery rooms, dressing rooms, and other places with invasive procedures should be directed to appropriate soak away pits.
- (viii) For HCFs located in urban areas the most appropriate option for wastewater disposal is connection to the existing sewer systems.
- (ix) Provide proper faecal sludge emptying methods for HCFs with on-site sanitary facilities

### 6.6.3 Wastewater treatment systems

For protection of public health and environment, it is recommended that wastewater generated at HCFs is treated onsite before final disposal. Wastewater in HCFs comprises black water (sewage), grey water or sullage and storm water.

The following are the recommended treatment methods for wastewater which HCFs may opt to use:

- (i) Anaerobic reactor system
- (ii) Decentralised septic tank system

#### 6.6.3.1 Anaerobic treatment system

This system consists of a primary and secondary treatment stage, and it should be used where HCF area

is large enough to provide for construction of waste water treatment plant. Figure 6.8 below shows a schematic of a basic hospital wastewater-treatment system.

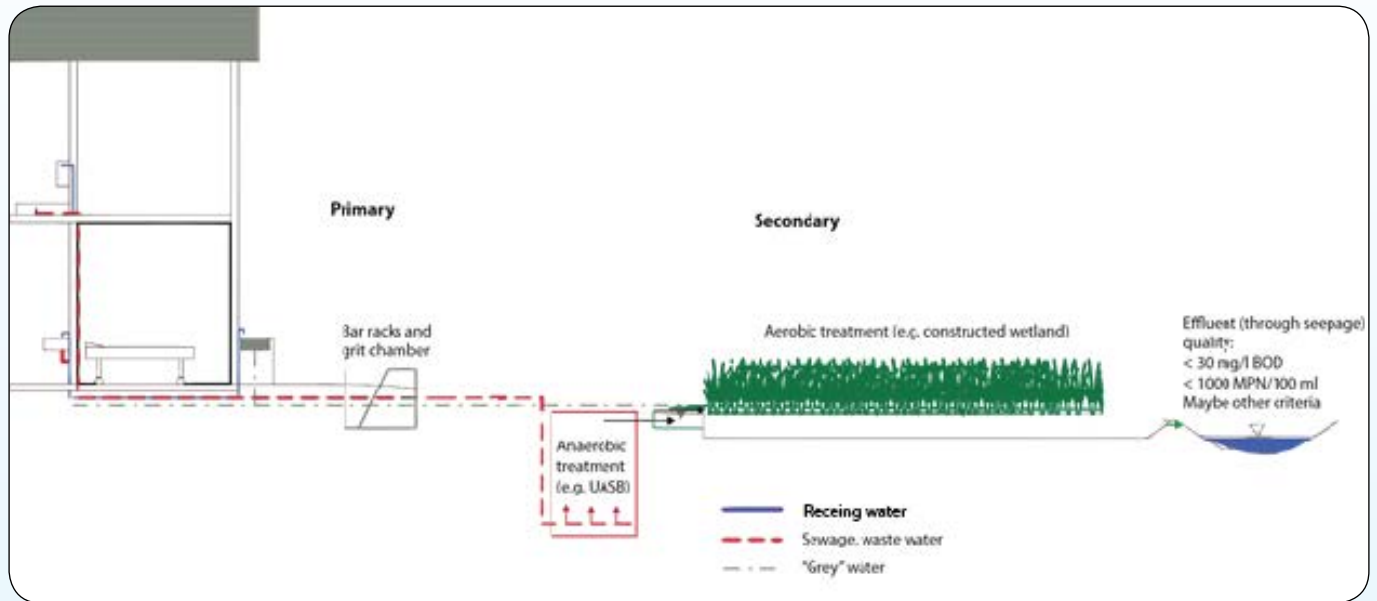
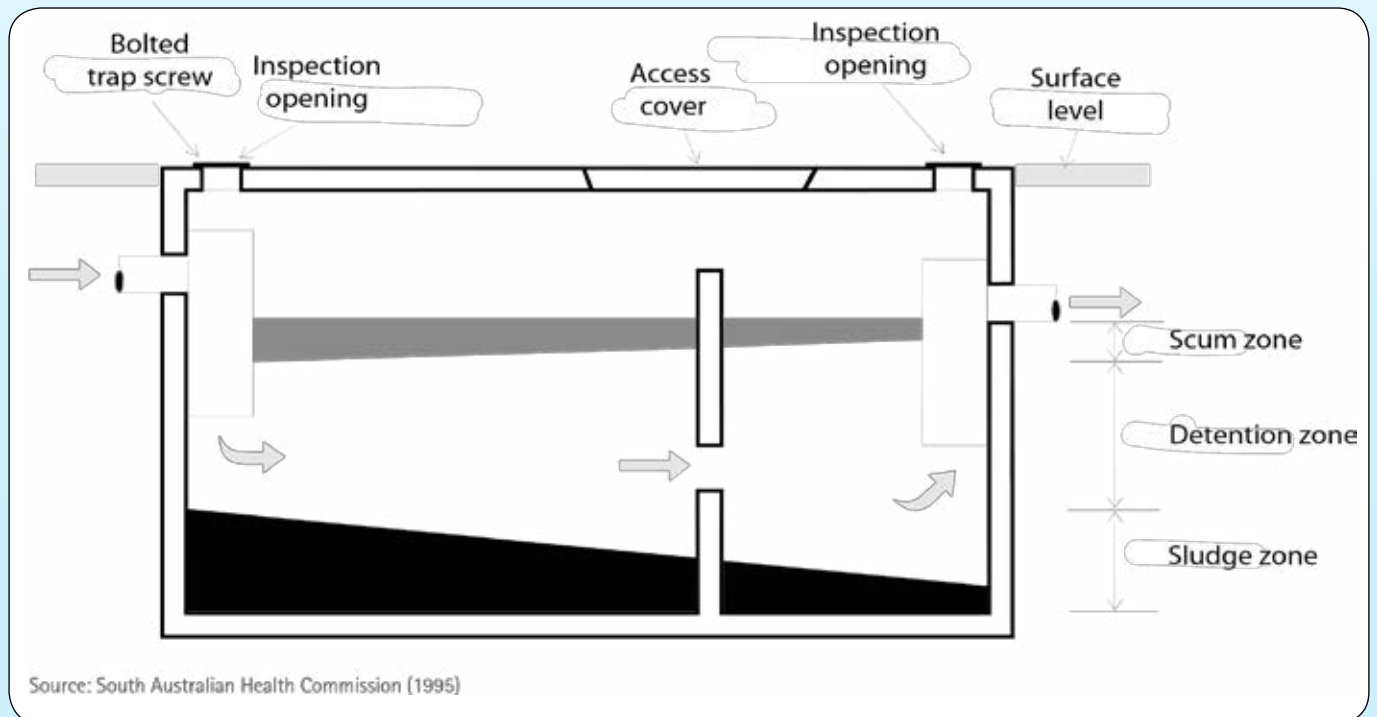

**Figure 6.8: Example of anaerobic treatment system**

\* BOD, biological oxygen demand; MPN, most probable number; UASB, up-flow anaerobic sludge blanket

### 6.6.3.2 Decentralized septic tank system

The minimum treatment method for wastewater in HCFs should be a septic tank which has a watertight receptacle for the separation of solid and liquid components of wastewater and for the digestion of organic matter in an anaerobic environment. A constructed septic tank should consist of two or more chambers and can be divided into the following zones: *Horizontal*: inflow, settlement and clarifying zone and *Vertical*: scum, detention and sludge zone. A cross section part of a septic tank is shown in Figure 6.9.



Source: South Australian Health Commission (1995)

**Figure 6.9: A cross section of a septic tank**

### 6.6.3.3 Guidelines for construction of Decentralised system

The capacity of the septic tank should be equivalent to a total of two days' wastewater flow. If a two-chamber system is used, the first chamber should be two thirds of the total capacity. Access holes, inspection ports and ventilation should be installed in every chamber.

**Note:**

*If levels of solid matter cannot be controlled, it should be removed once every two years*

The wastewater enters the septic tank via a ventilated pipe. The heavier solid matter (sludge) falls to the bottom; fats and other lighter matter (scum) float to the surface. The effective settling and floating of solids is directly dependent upon the retention time within the tank, which should be not less than 24 hours. Anaerobic bacteria partly break down this solid matter.

It should be noted that excessive build-up of sludge and scum reduces the capacity of the detention zone, resulting in discharge of suspended solids to the effluent disposal system. Solid matter (sludge, scum) from septic tanks must be removed when the chambers are half filled with sludge. If the level of solid matter cannot be controlled, it should ideally be removed once every two years.

### 6.6.3.4 Pre-treatment of liquid waste

Service delivery in some health facility departments may result into generation of wastes containing high composition of heavy metals or other constituents that can impair efficiency of the management system. Liquid waste from these departments should therefore be pre-treated before discharging into the waste treatment systems. A summary of treatment options for liquid waste from various department of hospital generating hazardous waste is in Table 6.2.

**Table 6.2: Pre-treatment of liquid waste**

Department/ section	Pre- treatment method(s)
Dental Department	Installing of amalgam separators in sinks, especially by patient treatment chairs. The separated mercury waste must be safely stored.
Radiology department	Separate collection of radioactive wastewater (e.g. urine of patients from the thyroid treatment) and storage for decay in a secured die-away basin until background concentrations have decreased. After the required storage time, the wastewater can be disposed of in the sewer system.
Kitchen	Installation of grease trap to remove grease, oil, and other floating materials

### 6.6.4 Management of faecal sludge

Onsite sanitation results into accumulation of faecal sludge which would require emptying and further treatment to reduce microbial and nutrients load hazardous to human and environment. The physical, chemical and bacteriological characteristics of the faecal sludge vary depending on toilet usage, inflow and infiltration, collection methods and climate. Design and construction of treatment methods of faecal sludge should therefore consider characteristics of prior to designing for effective desludging and treatment.

#### 6.6.4.1 Technology for treatment of faecal sludge

Established technologies for treatment of faecal sludge include co- composting, co- treatment in waste stabilization ponds or through deep well entrenchment. Depending on treatment goal HCFs may adopt other innovative ways for treatment especially when the goal is to recover resources. Vermicomposting, black soldier flies, ammonia treatment, thermal drying and pelletizing, and solar drying are examples of treatment methods for resource recovery (Strande et al., 2014). In Tanzania co- treatment in waste stabilization ponds is the common method used while other methods operate on experimental or pilot scales.



### 6.6.4.2 Selection criteria for treatment technology

The choice of treatment methods is influenced among others by the type of onsite sanitation system being used, the sludge quantity and characteristics, rain patterns (quantity, distribution over time) and the institutional set up. Designers and planners should therefore regard faecal sludge management methods as a combination of systems that facilitate efficient desludging, transportation, treatment and the intended end use. Table 6.3 summarizes the criteria for selection of faecal sludge management technologies.

**Table 6.3: Sludge treatment options in health care facilities**

S/N	Treatment technology	Advantages	Disadvantages
1	Co-composting of faecal sludge with municipal waste	<ul style="list-style-type: none"> <li>The output of co-composting is a good soil conditioner which provide potential for income generation</li> </ul>	<ul style="list-style-type: none"> <li>Operating a composting plant and generating a safe product with value requires technical and managerial skills</li> </ul>
2	Co treatment in waste stabilization ponds	<ul style="list-style-type: none"> <li>Waste stabilization ponds are simple to build</li> <li>Require relatively low operation and maintenance</li> <li>Appropriate for tropical climate</li> <li>Achieve high pathogenic removal in the effluent</li> </ul>	<ul style="list-style-type: none"> <li>Land availability</li> <li>High rates of solid accumulations if preliminary solids separation is not performed</li> <li>Potential inhibition due to high salt and ammonia concentration</li> <li>Removal of sludge that accumulate in the anaerobic ponds may require heavy mechanical equipment (Strauss et al., 2000)</li> </ul>
3	Deep row entrenchment	<ul style="list-style-type: none"> <li>No need of expensive infrastructure or pumps</li> <li>Growing tree has numerous benefits such as CO<sub>2</sub> fixation, erosion protection</li> </ul>	<ul style="list-style-type: none"> <li>Sufficient land has to be available in an area with a low ground water table</li> <li>Legislative control are required to be instituted</li> </ul>
4	Anaerobic digestion	<ul style="list-style-type: none"> <li>Produces biogas while stabilizing faecal sludge</li> <li>Reduces sludge volume and odour</li> </ul>	<ul style="list-style-type: none"> <li>Operation and maintenance requires relatively high skilled operations</li> <li>Restriction measures for detergents and heavy metals should need to be instituted</li> <li>Need for pilot scale prior to full scale implementation to learn more about safety and sustainability</li> </ul>
5	Imhoff tank	<ul style="list-style-type: none"> <li>Small land requirement</li> <li>There is possibility of operating only one tank (Klingel et al., 2002)</li> <li>Physical separation between the settled sludge and the liquid fraction</li> </ul>	<ul style="list-style-type: none"> <li>Increased operation complexity as compared to other methods</li> <li>Comparatively high cost</li> <li>Require skilled operator</li> </ul>
6	Sludge incineration	<ul style="list-style-type: none"> <li>The sludge volume is substantially reduced and 'All pathogens are removed</li> </ul>	<ul style="list-style-type: none"> <li>Potential emission of pollutants</li> <li>Need for highly skilled operating and maintenance staff</li> <li>High capital and O&amp;M costs</li> <li>Residual ashes</li> </ul>

**Table 6.4: Criteria for selection of faecal sludge treatment options**

Treatment performance	Local context	O&M requirement	Costs
Effluent and sludge quality according to national standards	<ul style="list-style-type: none"> <li>• Characteristics of sludge (dewaterability, concentration, degree of digestion, spreadability)</li> <li>• Quantity and frequency of sludge discharge at Faecal sludge treatment plan</li> <li>• Climate</li> <li>• Land availability and cost</li> <li>• Interest in end use (fertilizer, forage, biogas, compost, fuel)</li> </ul>	<ul style="list-style-type: none"> <li>• Skills needed for operation, maintenance and monitoring available locally</li> <li>• Spare parts available locally</li> </ul>	<ul style="list-style-type: none"> <li>• Investment costs covered (land, infrastructure, capacity building)</li> <li>• O&amp;M costs covered</li> <li>• Affordability to users</li> </ul>

Source: *Strande et al, 2014*

The selection process for faecal sludge management system is a participatory process and therefore should involve various stakeholders specifically land use planners, water engineers, environmental engineers, private sector among others. HCF management should utilize environmental health officers (EHOs) in carrying out all processes for selection of appropriate technology for the treatment of accumulated faecal sludge in HCFs. Figure 6.10 is a prototype technology selection scheme.

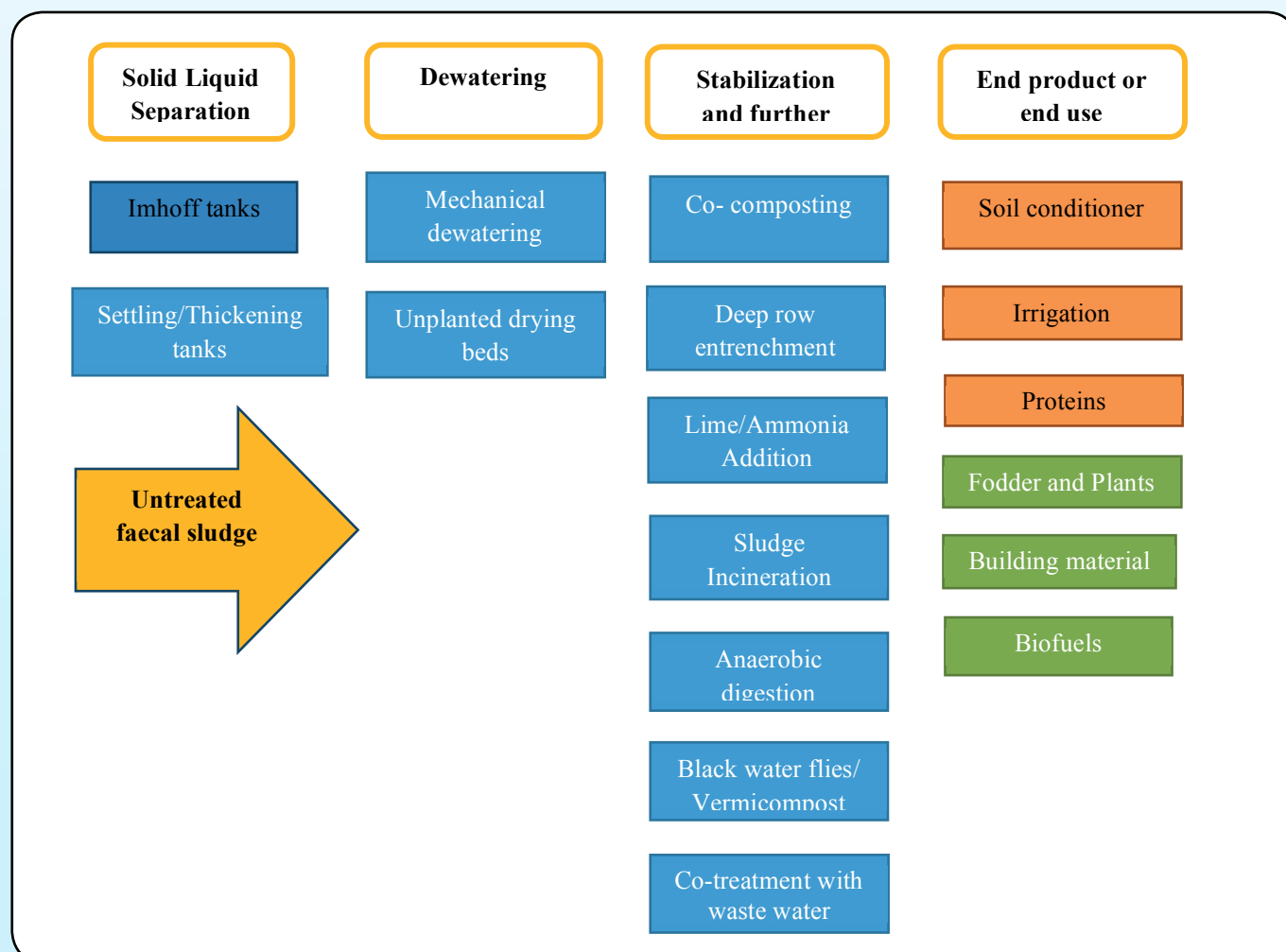

**Figure 6.10: Photo-type technology selection scheme**

Source: *Modified from Strande et al, (2014)*

### 6.6.5 Management of storm water

Storm water refers to water that flows over land from rainfall, and very often causing flooding, erosion and pollution. For proper management of storm water it is important to consider the following;

All buildings should be provided with appropriate storm water drainage to convey water away from the compound

All storm water drainage/open channels should be cleaned up regularly to avoid blockage

#### 6.6.5.1 General storm-water control requirements

In general, storm water management consists of collecting, retaining (infiltrating) and/or detaining runoff before it is released to a natural drainage course. Simple and effective management strategies should be employed to either infiltrate or disperse the runoff on site. However, in some sites, such as, steep sites or sites receiving substantial runoff from adjoining properties more extensive drainage improvements may be necessary to collect and convey runoff in pipes in a safe manner to protect the HCF and property as well as the downstream drainage course or neighbouring properties. On large sites excessive runoff may need to be detained in a detention pond to protect a downstream watercourse or an adjacent property.

Design and construction of a storm water drainage system should be according to the ministry's guidelines. A summary of important considerations for designing and maintenance of storm water are summarized here under

#### 6.6.5.2 Storm water management for small size health care facilities

For HCFs with less than or equal to 2 acres (0.8ha), and appropriate conditions such as safe from risk of flooding, infiltration trenches or shallow dry wells should be used to capture and retain runoff from impermeable surfaces. Impermeable surfaces include roofs, parking lots, driveways, and paved areas. Alternative methods for capturing run off are splash blocks, vegetated and rock-lined swales and shallow rocked trenches.

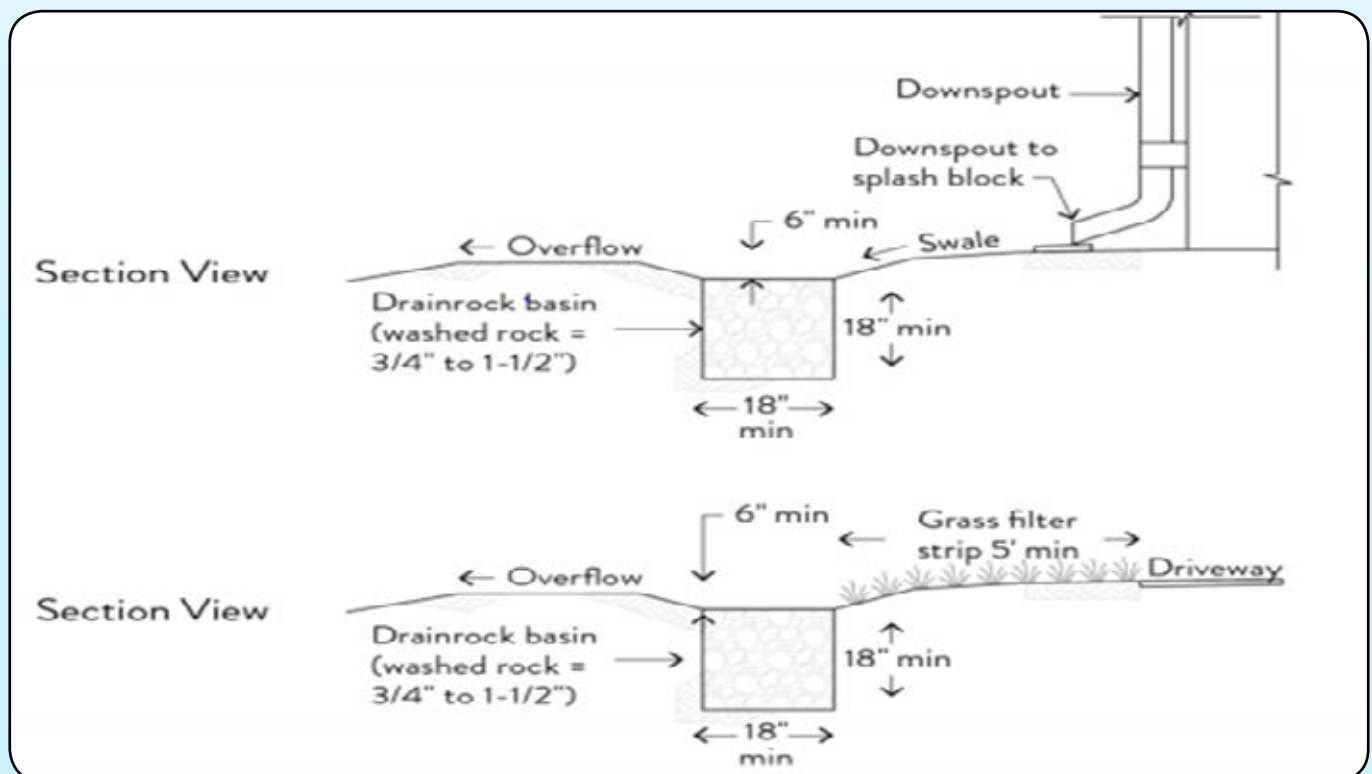

Figure 6.11: A typical example of down spout infiltration

### 6.6.5.3 Storm water management for large health care facilities

Designing and installation of storm water management practices for larger HCFs with larger than 2 acres (0.8ha) or those located in flood prone areas or on steep slopes, require more in-depth drainage analysis, planning and engineering to properly manage runoff. Higher level HCFs, such as a consultant hospitals, regional referral hospitals and district hospitals require the installation of a piped storm drain network to collect, convey and manage runoff in a safe and effective manner. Major considerations during design are:

- (i) Complete drainage analysis to properly size drainage collection, conveyance, storage and treatment systems. The drainage analysis should be completed by a qualified engineer with experience in drainage engineering.
- (ii) Design roof runoff collection systems to accommodate the peak flows from the 2-minute, 10-year rainfall equivalent to 15in (38.1cm) per hour.
- (iii) Detention ponds and bio-retention swales can be constructed for temporarily detaining runoff to reduce the rate at which storm-water flows off the facility and control erosion or flash flooding down slope

### 6.7 Operations and maintenance of sanitation facilities

Sanitation infrastructure and facilities requires careful organization and actions to ensure smooth operations and provision of maintenance services in case of structural or functional changes. Routine and periodic maintenance services are prerequisite for sustaining sanitation facilities in health care facilities.

- (i) There should be a clear description of staff roles on management of sanitation infrastructure and services. Depending on the facility level there should be a committee consisting of a manager, supervisor(s), and attendant(s) each with assigned responsibilities in relation to maintaining sanitation infrastructure.
- (ii) Toilets should be cleaned whenever they are dirty, and at least thrice a day with a disinfectant used on all exposed surfaces and a brush to remove visible soiling. Strong disinfectants are unnecessary and should not be used in large quantities (reference: Essential environmental health standards in HCF, 2008).
- (iii) There should be weekly and daily cleaning schedule that specify when sanitation facilities should be cleaned and supplied with cleaning and hygiene agents. Cleaning schedule should identify persons or groups responsible for undertaking the cleaning tasks and their supervisors. The schedules should be displayed for easy access and be shared among responsible managers.
- (iv) Orientation, training, and education of users is an important aspect of operations that must be implemented. Orientation materials, personnel and time should be dedicated to help new comers, regular visitors, and staff members.
- (v) Operation and maintenance plan must be put in place to cover for the running and repairs of sanitation infrastructure and services. This should include regular or incidental repairs and scheduled maintenance activities.
- (vi) Monitoring tools for sanitation in Health Care facilities will be developed centrally. It will be the responsibility of each individual facility to obtain tools for monitoring and evaluation exercise, and to make sure that they are being implemented on time.
- (vii) Faecal sludge should be emptied when the septic tank is  $\frac{3}{4}$  full.
- (viii) Cleaning and maintenance inspection activities should be documented and reported in weekly meetings.

## CHAPTER SEVEN

### 7.0 HYGIENE IN HEALTH CARE FACILITIES

#### 7.1 Introduction

Good hygiene practices such as hand hygiene, bathing and use of personal protective equipment are very important in preventing the acquisition and spread of infectious microorganisms among health care staff, patients and carers. If done properly, such practices are simple and inexpensive methods of preventing the spread of HCAs. Furthermore, studies have shown that defective or inadequate hand cleaning offers the ability of microorganisms to survive on hands for differing times especially in HCFs whereby the hands of the health care workers (HCWs) become progressively colonized with pathogenic and non-pathogenic during patient care. Thus, it has been indicated that, the longer the duration of care, the higher the degree of hand contamination.

This chapter provides guidelines for maintaining effective hygiene practices within the health care environment which should be adhered by HCFs at all levels in order to minimize risks of contamination. Other related hygiene issues addressed in the chapter include proper laundry and kitchen management, mortuary hygiene as well as environmental management in relation to vector and vermin control.

#### 7.2 Guidelines for hand hygiene in health care facilities

##### 7.2.1 Awareness on transmission of pathogens by hands

It is important that all HCWs should have adequate knowledge on how HCAs are transmitted. This knowledge will help them to take precautions and remedial measures in handling patients and any other contaminated materials or objects within the health care facility.

##### 7.2.2 Hand hygiene practices

###### 7.2.2.1 Routine hand washing

Proper or effective hand-washing with soap aims at removing visible dirty, soil and various organic substances from the hands and most importantly, reducing bacterial counts on the skin. Proper hand washing consists of eleven (11) steps and should take between 40-60 seconds. Figure 7.1 clearly illustrates these steps.





**Figure 7.1: Steps for routine hand washing**

*Adapted from WHO Guidelines on Hand Hygiene in Health Care, 2009*

### 7.2.2.2 Proper drying of hands

It is a fact that transmission of bacteria is more likely to occur from wet skin than from dry skin. Therefore, proper drying of hands after washing should be part and parcel of the hand hygiene process in provision of health care. Proper drying of hands can remove bacteria from the hands rather than only shaking the hands after washing. Drying up of hands after washing can be done by using automated dryers, paper towels and sterile towels. It is strongly recommended that paper towels should be used once and discarded into hands-free non-risk waste bin. Clean cloth towels should not be used as they are likely to be susceptible to contamination due to multiple uses by different people.



### 7.2.2.3 Paper towels

Paper towels are used for drying hands after washing. They are effective, safe and fast, in hand drying than other methods since they dry hands more quickly, remove bacteria and are less likely to lead to cross contamination. Paper towels also offer the advantages of not requiring electrical power as is the case in many rural and remote areas of Tanzania. In order to make effective use of paper towels HCFs will have to do the following:

- (i) Provide paper towel dispensers in all areas where hand washing facilities are installed.
- (ii) Towel dispensers should be mounted such that access to them is free and splashing or dripping onto adjacent wall and floor surfaces is minimized.
- (iii) Provide single - use paper to turn off faucets so as to avoid hand recontamination.
- (iv) Air dryers are discouraged in HCFs as warm air currents dry hands slowly and can be used by only one individual at a time which may result into unnecessary queues and the temptation to dry hands on personal clothing.
- (v) Provide lidded, lined, foot pedal - operated waste bins, with waste bags, in close proximity to each hand washing sink.

### 7.2.3 Critical moments of hand hygiene in health care facilities

#### 7.2.3.1 Hand hygiene in patient handling

Care has to be taken before, during and after handling or touching a patient. Critical moments of hand hygiene are illustrated in Figure 7.2. Hence HCWs should ensure that their hands are properly washed with soap and water at these critical moments as they can easily contaminate their hands at different occasions such as lifting a patient, wound dressing, taking a patient's pulse, blood pressure, or oral temperature, touching a patient's hand, shoulder or groin.

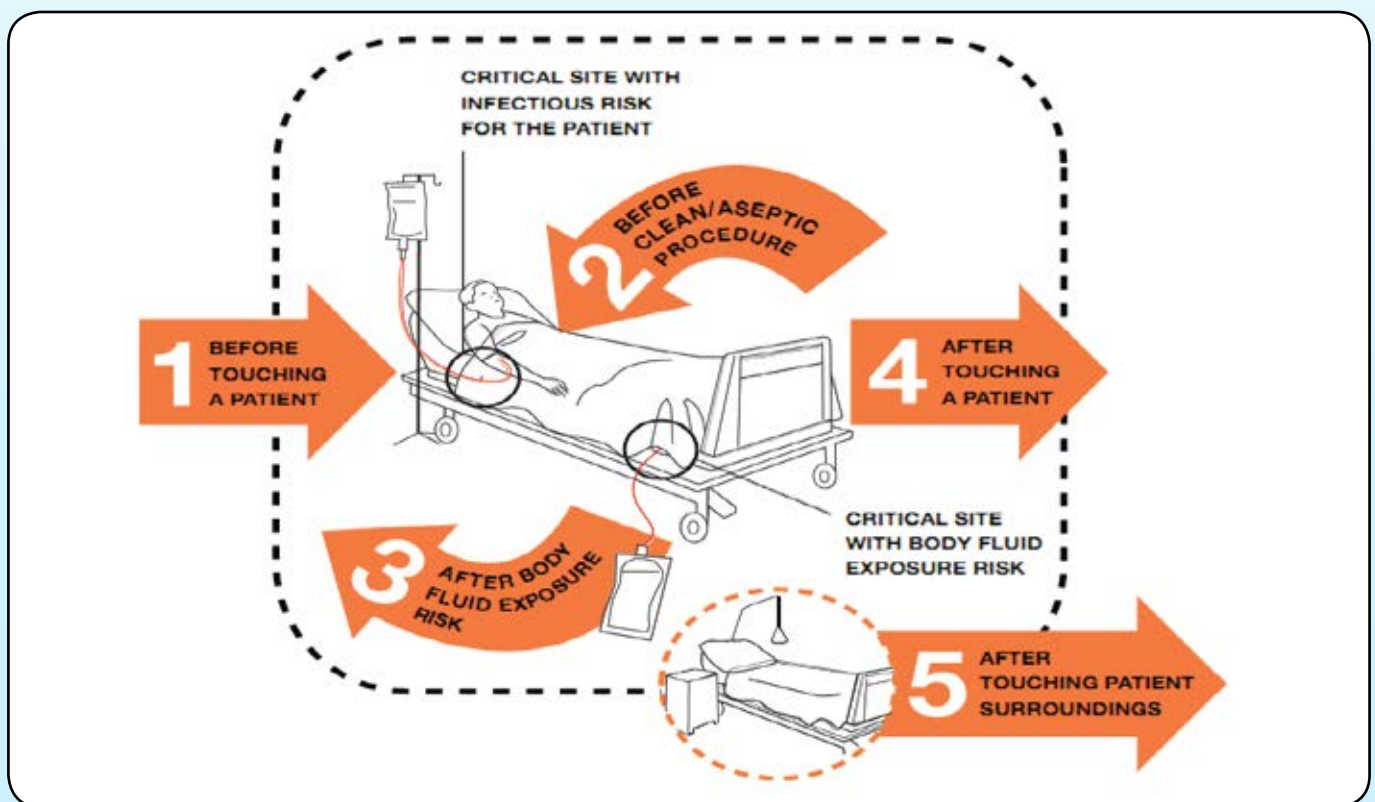

Figure 7.2: Critical moments of hand hygiene in health care facilities

Source: *Guidelines on Hand Hygiene in Health Care (WHO, 2009)*

### 7.2.3.2 Other critical moments for hand hygiene

Apart from the moments in handling patients, proper hand washing in HCF environment should be done:

- (i) When hands are visibly dirty, or soiled with blood or other body fluids.
- (ii) After visiting the toilet
- (iii) Before eating
- (iv) Before preparing food
- (v) Before entering and leaving inpatient wards or any working area of the health facility setting
- (vi) After contact with inanimate surfaces and objects (including medical equipment) in the immediate vicinity of the patient
- (vii) Before and after feeding a patient
- (viii) Before putting on gloves and immediately after removing gloves
- (ix) Before and after caring any patient

#### REMEMBER!

*It is a universally acceptable standard to wear gloves during all patient care activities that may involve exposure to blood or body fluids that may be contaminated with blood. However, practice should not replace the need for proper hand washing as gloves do not provide complete protection against hand contamination. Hand contamination may occur in instances where gloves are either defective thus allowing some pathogens to gain access to the HCWs hands or by contamination of the hands during the glove removal.*

### 7.2.4 Antiseptic hand rubbing

All HCFs should make available alcohol rub (Alcohols: Isopropyl 60–70% Ethanol 70–90% includes methylated spirit 70%) at the point of care and should conform to the national specifications for alcohol-based hand hygiene products. The alcohol rub should be kept in secure place in order to avoid risk of accidental or intentional ingestion at the point of care by individual patient. It should be applied when hands are not visibly soiled in order to decontaminate hands and should follow the steps illustrated in Figure 7.3.

# How to Handrub?

**RUB HANDS FOR HAND HYGIENE! WASH HANDS WHEN VISIBLY SOILED**

**⌚ Duration of the entire procedure: 20-30 seconds**

**1a**



Apply a palmful of the product in a cupped hand, covering all surfaces;

**1b**



Rub hands palm to palm;

**2**



Rub hands palm to palm;

**3**



Right palm over left dorsum with interlaced fingers and vice versa;

**4**



Palm to palm with fingers interlaced;

**5**



Backs of fingers to opposing palms with fingers interlocked;

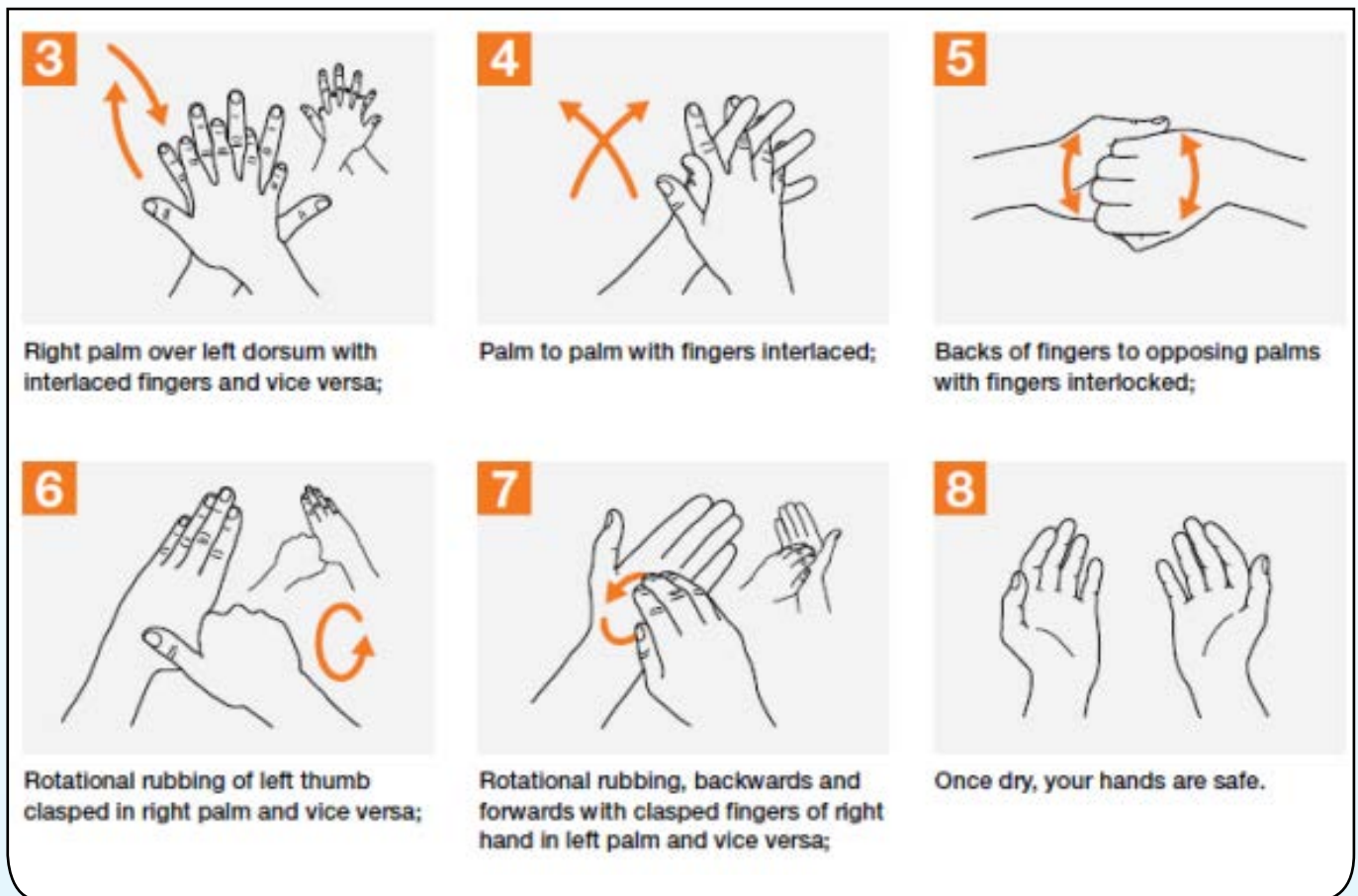

**Figure 7.3:Steps for hand rub**

**Source:** *World Health Organization (WHO) 2005*

### 7.2.5 Antiseptic hand washing

Hand antiseptics remove or destroy transient micro-organisms and confer a prolonged effect. They are similar to that for plain hand washing, but instead of plain soap, antiseptic or antimicrobial soap is used. The steps to be followed while performing antiseptic hand washing are similar to those outlined in Figure 7.1 above.

### 7.2.6 Surgical hand antisepsis

Surgical hand antisepsis aims at reducing the number of resident and transient flora to a minimum but also to inhibit their re-growth for as long as possible, not only on the hands but also on the wrists and forearm.

#### 7.2.6.1 Surgical hand preparation procedures

The objective of maintaining proper surgical hand hygiene is to reduce the skin bacteria from the hands of the team performing surgery during the process especially in case of unnoticed puncture of the surgical gloves which can release bacteria to the open wound. Unlike hand washing with soap or hand rub, surgical hand preparation should aim at eliminating the transient and reducing the resident flora. Also, it is intended to inhibit the growth of bacteria under the gloved hands.

In performing surgical hand preparation, the surgical team should use either an antimicrobial soap or an alcohol-based hand rub with persistent antimicrobial activity or surgical hand rub before to put on sterile gloves when performing surgical procedures. In performing this activity safety procedures and precautions should be adhered to as stipulated in National IPC Guideline, 2007.



### 7.2.6.2 Steps for surgical hand rub

For safety purposes the steps indicated in Figure 7.4 should be strictly followed when performing surgical hand rub.

<p><b>Step 1</b></p> <p>Apply appropriate amount of appropriate solution: 5ml dose from dispenser (one downward stroke action). Work into hands palm to palm and to encompass all areas of the hands and arms to just below the elbows as follows:</p> 	<p><b>Step 2</b></p> <p>Right palm over back of left and vice versa with fingers interlaced.</p> 
<p><b>Step 3</b></p> <p>Rub palm to palm, fingers interlaced.</p> 	<p><b>Step 4</b></p> <p>Rotational rubbing backwards and forwards with clasped fingers of right hand into left palm hand and vice versa.</p> 
<p><b>Step 5</b></p> <p>Rotational rubbing of right thumb clasped in left hand and vice versa.</p> 	<p><b>Step 6</b></p> <p>Rub finger tips on palms for both hands.</p> 
<p><b>Step 7</b></p> <p>Continue with rotating action down opposing arms, working to just below the elbows.</p> 	<p><b>Step 8</b></p> <p>Rinse and repeat steps 1-7 keeping hands raised above elbows at all times.</p> <p><b>This wash should now only cover two thirds of the forearms to avoid compromising cleanliness of hands.</b></p> <p>Local policy may include repeating these steps a third time but to wrists only.</p>
<p><b>Step 9</b></p> <p>Rinse hands under running water – clean to dirty area. Turn off tap using elbows if necessary.</p> <p>Open gown pack into a squared off surface and take a hand towel. Hands are dried first by placing the opposite hand behind the towel and blotting the skin, then, using a corkscrew movement, to dry from hand to elbow. Discard towel. Using a second towel, repeat the process on other hand and forearm before discarding.</p> 	

Figure 7.4: Steps for surgical hand rub

### 7.3 Hand washing facilities and specifications for health care facilities

In order to practice effective hand washing each HCF has to ensure that it provides adequate hand washing facilities. This sub-section provides basic facilities and materials required for this purpose. Annexes 1 and 2 provide a list of recommended numbers of hand washing facilities and their locations within different levels of HCF.



**Figure 7.5: Hand washing facility**

#### 7.3.1 Hand washing facilities and specifications

Hand washing facilities and materials are important for promotion of hand hygiene practices. Each HCF should have access of the hand washing facilities and materials with acceptable WHO specifications as presented in Table 7.1.

**Table 7.1: Specification of hand washing facilities in health care facilities**

HW Facility	Specifications
Hand washing basin	<ul style="list-style-type: none"> <li>• Should be made of non-porous material, round shape inside with dimensions of 25cm by 35cm depth and without overflow</li> <li>• Should be of elbow, foot or automatic operating taps, uPVC traps and plastic gadgets</li> <li>• Should be a wall-mounted basin fixed at 120cm above floor</li> </ul>
Soap/detergents dispenser	<ul style="list-style-type: none"> <li>• Should be soap dispenser (manual or automatic)</li> </ul>
Hand drying equipment/ materials	<ul style="list-style-type: none"> <li>• Should be a centered feed hand towel dispenser</li> <li>• Hand drying material should be a disposable paper towel</li> </ul>

HW Facility	Specifications
Water supply	<ul style="list-style-type: none"> <li>Both hot and cold water should be provided</li> </ul>
Sanitizer	<ul style="list-style-type: none"> <li>Should be used when hands are visibly clean</li> </ul>
Waste bin	<ul style="list-style-type: none"> <li>Should be a round black/blue pedal bin of 12 liters (340mm (height) x 270mm (diameter))</li> </ul>
Hand washing basin for disabled people	<ul style="list-style-type: none"> <li>Wheel chair accessible hand wash basin which is wall mounted with dimensions of 510mm (length) by 685mm (width).</li> </ul>

### 7.3.2 Surgeon scrub - sinks

These are plumbing fixtures well equipped to enable medical personnel to scrub their hands prior to a surgical procedure. Surgical scrub sinks are essentially used in an operating theater and are designed in a way that promote proper hand washing practices and reduce any possible contamination since all operating tools are sterilized. The sinks are provided with hot and cold water supply which is activated by a knee-action mixing valve or by wrist or foot control as shown in Figure 7.6. Another option of the surgical scrub sink is shown in Figure 7.7.

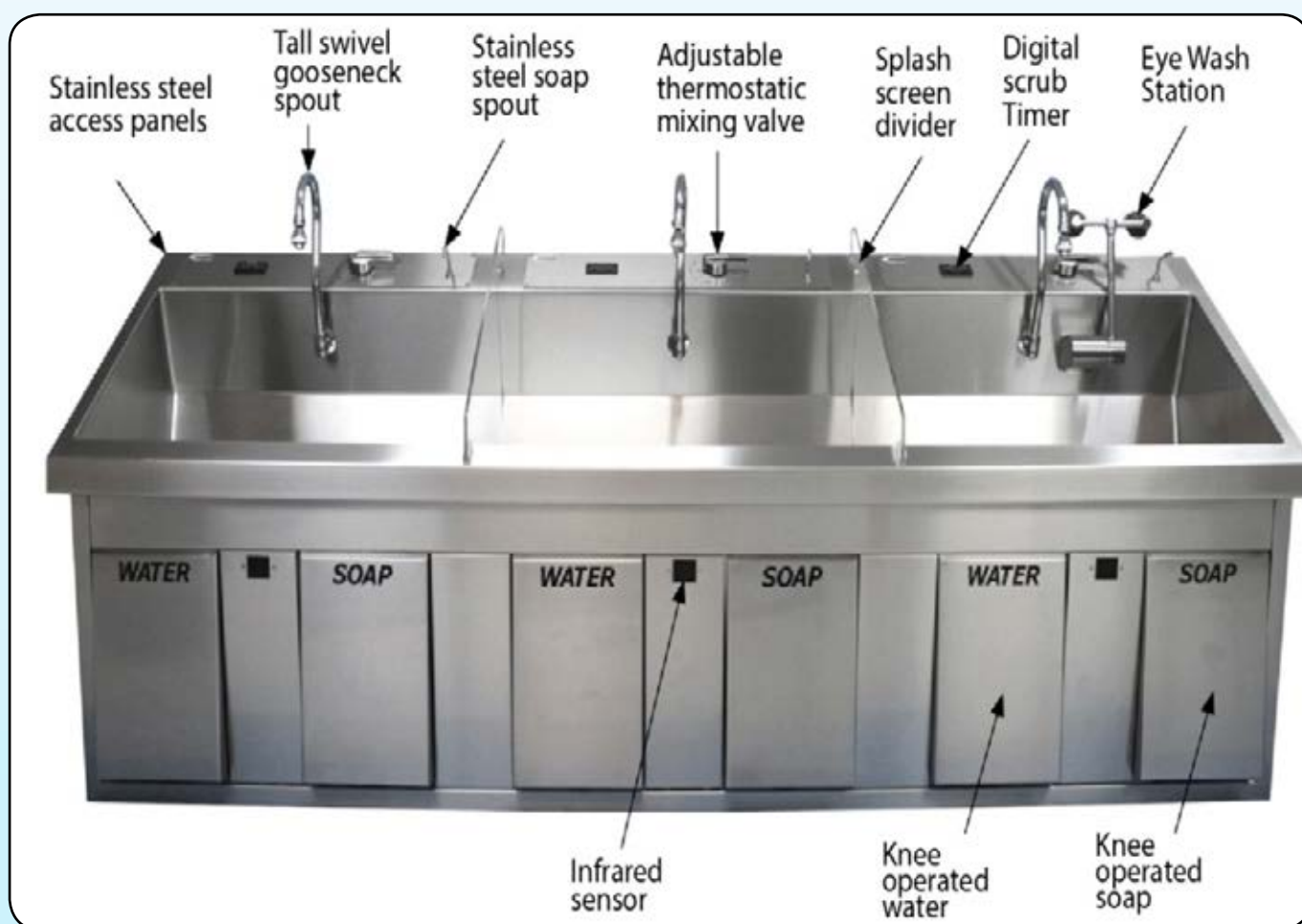

**Figure 7.6: Types of surgical scrub sinks**

For maintaining the required hygiene practices the surgeon scrub sink should have the following characteristics:

- (i) Made of vitreous china, stainless steel, or a material whose durability and imperviousness are equivalent to vitreous china;
- (ii) Adequate size and designed to permit the scrubbing of both hands and arms without having to come in contact with any surface;



- (iii) Shaped and sized to prevent splashing of the user;
- (iv) A non - swivel faucet that provides adequate flow for quick rinsing;
- (v) Hands - free operation (electric eye or knee/foot operation) to prevent contamination of the hands when water is activated;
- (vi) Provide manual means for adjusting water temperature;
- (vii) Equipped with a seam - free backsplash integral with the sink that extends at least 60 cm above sink level;
- (viii) Provide backsplashes covering the areas under the paper towel dispenser and soap dispenser.



**Figure 7.7: Photo- type of surgical scrub sink**

### 7.3.3 Hand hygiene facility usage and maintenance

The following precautions should be taken in order to ensure proper use of hand hygiene facilities and maintenance:

- (i) Hand hygiene facilities should not be dedicated to any other purpose
- (ii) Hand washing facilities should be regularly inspected and cleaned to ensure they remain in good working condition.
- (iii) Paper towels and liquid soap should be provided at each hand washing sink.
- (iv) A current hand washing guide should be posted at each hand washing sink in order promote proper hand washing

#### **IMPORTANT NOTE:**

*Hand washing facilities (sink, water, soap, antiseptic and paper towel or drier) should be provided for all toilet compartments and sections/rooms which provides services*

## 7.4 Guidelines for bathroom hygiene

Bathrooms are important infrastructures for both patients and HCWs for preventing and controlling transmission of diseases. To improve hygiene practices within HCFs it is necessary to have adequate numbers of bathrooms which correspond to the level of bed capacities and staffing levels with the ratio of patient per bathroom of 1:6.

A proper bathroom within the HCF should have the basic qualities as outlined in the box below.

### Minimum qualities of a bathroom in HCF

- *A minimum surface area of 3.25m<sup>2</sup>*
- *Well drained non slippery floor*
- *Impervious walls*
- *Mixture taps for both cold and hot water*
- *Adequate lighting and ventilation for use safety*
- *Furnished with wall mounted seats with functional emergence alarm call system with free room for wheelchair maneuvering*
- *Bathrooms should be separated for HCWs and patients and clearly labeled to identify the type of users and sex.*

The minimum requirements of bathrooms for each level of HCF are provided in Annex 3.

## 7.5 Guideline for laundry hygiene

In HCFs soiled linen harbours pathogenic microorganisms, and hence the risk of actual disease transmission from soiled linen is inevitable. Proper handling of linen will help to reduce possible risks of transmitting diseases causing microorganisms from contaminated patient linens to HCF workers and also reduce hospital acquired infections from linens to patients.

### 7.5.1 Safe handling of laundry

HCF laundries should be well designed with good drainage system easy to clean and must conform to the standards and procedures spell out in the guidelines for Health Care Waste Management (HCWM). Hence, laundries in HCFs must have the following minimum qualities:

- (i) The laundry should not be located in a site which is directly accessible to the kitchen.
- (ii) The design of the laundry should facilitate the creation of dirty and clean areas to prevent cross contamination.
- (iii) A separate hand hygiene sink for staff with wall mounted dispensers for soap and paper towels should be provided.
- (iv) All workers at the laundry should be vaccinated against Hepatitis B virus and TT
- (v) Appropriate PPE should be worn by laundry staff as required.
- (vi) There should be a changing room for staff
- (vii) Washable smooth walls, edges, corners and projections with glazed ceramic tiles should be fixed up to 8 inches high.
- (viii) The laundry room should have a smooth ceiling, washable surface and enough height to allow installation and repair.
- (ix) Laundry containers/skids should be part of a routine cleaning schedule.

### 7.5.2 Basic principles in handling linen

All used linen should be handled with care to avoid dispersal or microorganisms into the environment and to avoid contact with staff clothing. HCFs should therefore comply with the following principles for linen used by all patients regardless of their infectious status:

- (i) All used linen should be considered contaminated thus requiring cautious handling.
- (ii) Appropriate PPE must be worn during the handling of soiled linen to prevent skin and mucous membrane exposure to blood and body fluids.
- (iii) All linen should be disposed into an appropriate linen container at the point of care.
- (iv) Linen which is heavily contaminated with blood and/or other body fluids which could leak should be contained by a leak-proof bag and secure prior to transport.
- (v) Hand hygiene must be performed following the handling of all used Linen or clothing soiled with blood or body fluids should be placed in an alginate or water soluble bags at the point of care.
- (vi) Linen or clothes soiled with blood or body fluids should be machine-washed using soap/detergent at or above 60°C. A biological washing powder is highly recommended.
- (vii) Always hold used linen and clothing away to avoid contaminating staff clothing.
- (viii) As a precaution measure, laundry service providers should avoid filling the alginate bags more than 2/3 full.
- (ix) Rinsing or spraying clothes soiled with blood or body fluids by hand or carrying out manual sluicing should be discouraged.
- (x) Sharps objects and other items such as incontinence wear should not be inadvertently discarded into laundry bags.
- (xi) Clean and soiled linen should be stored separately.
- (xii) Clean soiled mattresses by wiping with 0.5% chlorine solution and letting them dry before putting clean linen on them.
- (xiii) Proper collection and transport of linen should be maintained (see the box below).

#### Basic guidelines for collection and transportation of HCF linen

- *Used linen is transported from the ward to the laundry in leak proof containers with lids or covers, to avoid leaking.*
- *Extra linen is not left in patients' rooms.*
- *Items are checked for cleanliness and rewash if necessary.*
- *Washed linen is placed in clean containers or on clean surfaces.*
- *Carts, marked trolleys or other leak proof containers are cleaned before taking clean linen back to the wards.*
- *Clean linen is covered or wrapped during transportation*



Figure 7.8: Showing laundry hampers

### 7.5.3 Operation and maintenance of a laundry facility

Simple preventative maintenance practices on washer-extractors and tumble dryers, helps to extend the life of the equipment. Hence, it is important that the following preventive practices should be done as recommended:

- (i) There should be a working schedule for daily, weekly and monthly laundry cleanliness and laundry monthly assessment tool to determine any damage of the laundry facility and plan for replacements and repair.
- (ii) Staff working in laundry should wipe down the door seals at least once a day to make sure they are dry and clean. This will prevent dirt and grime from accumulating on the door gasket, which can cause leaking.
- (iii) Each day laundry staffs should check all visible hoses, paying close attention to the water inlet valve hose connection on the machine's backside as well as any chemical connections.
- (iv) The lint compartment and screen are to be cleaned on a daily basis. Doing so will allow electrical components to blow, maintaining proper airflow and avoiding overheating.
- (v) It is important for staff to check the cylinder daily for such debris to avoid damage to the linens and the equipment.
- (vi) It is also important to wipe down the outside surfaces of both washer-extractors and tumble dryers each day. This will significantly reduce the need for additional maintenance and deep cleaning caused by a build-up of lint, debris and chemical remnants.

### 7.5.4 Guidelines for kitchen hygiene

Food can become contaminated at any point during preparation and distribution within the kitchens. Food may be contaminated with disease organism during preparation or storage if main hygiene aspects are not taken into considerations, these are contaminated hands, polluted water, flies and utensils for serving cooked food. Food handlers have a role to play to ensure the prepared food does not cause disease transmission.

HCF kitchens should be well designed with good drainage system, ventilation, easy to clean, and should conform to standards and procedures for running food premises as stipulated by TFDA. The kitchen should have separate toilets for male and female with adequate hand washing facilities and proper waste collection. Moreover, kitchen services (outsourced or operated by HCF), should be closely monitored by a designated Environmental Health Officer for quality assurance.

## 7.6 Guidelines for mortuary hygiene

This section refers to maintenance of hygiene in Mortuary. Specifically it highlights guidelines on general cleaning, laundering and disinfection of equipment. It also provides details about the functioning of refrigerators, availability of formalin, use of PPE, vaccination, available post exposure prophylaxis, HCWM and information on hand hygiene facilities.

### 7.6.1 General cleaning

This includes cleaning of the different areas such as preparation tables, chairs, lights, doors, cupboards, floors, walls, washing sinks, washrooms and windows. The general cleaning procedures in the mortuary should be as follows:

- (i) Cleaning is carried out every day in the morning hours, after every service or whenever necessary.
- (ii) All parts of equipment and furniture that was used to provide mortuary services should be cleaned by using disinfectants mixed with soaps.
- (iii) Linen and mackintosh after post-mortem examination should be changed
- (iv) Single use gloves should be worn when handling contaminated re-useable linen and placed in a laundry bag for routine laundering.
- (v) Cleaning equipment such as mop and brushes should be cleaned after use. If they are solid they have to soak in Chlorine solution 0.5% for 10 minutes and then dried.

### 7.6.2 Cleaning and disinfection of essential post-mortem/autopsy equipment

When cleaning and disinfecting of essential equipment for post-mortem and autopsy the following aspects should be seriously taken into account:

- (i) Cleaning of instruments must be done in a dedicated sink and not the normal hand washing sink
- (ii) Personal protective equipment preferably heavy utility gloves should be worn while cleaning
- (iii) Instruments used on contact skin should be cleaned and stored in a dry place, but instruments that penetrate the skin must undergo cleaning and sterilization.
- (iv) Used items should be removed from their transport containers and sorted out according to the appropriate cleaning method.
- (v) If cleaning cannot be performed immediately, then instruments should be covered in warm water to prevent soils from becoming fixed, which would make cleaning difficult
- (vi) Instruments should not be soaked for longer than one hour. Instruments that cannot be immersed should be cleaned immediately
- (vii) Disinfectant solutions should be labeled appropriately (with the name, date and dilution strength)
- (viii) Chemical disinfection should be used only for items for which sterilization and thermal disinfection are not suitable for example, items unable to be immersed in water (thermal) or unable to withstand high-pressure gradients (sterilization).
- (ix) Sufficient and appropriate disinfectant should be 0.1% hypochlorite solution for routine mortuary work, embalming and post-mortems.
- (x) Soaking should be done in 0.1% hypochlorite solution in a plastic container for 10 minutes then removed and rinsed with distilled water before being dried and stored.
- (xi) Chemical disinfectant solutions should be discarded immediately after use.
- (xii) The container should have a close-fitting lid.

### 7.7 Other essential aspects in maintaining mortuary hygiene

In addition to the above guidelines other critical hygiene practices which each HCF are properly addressed in the mortuary environment are outlined in Table 7.2.

**Table 7.2: Other critical aspects in maintaining mortuary hygiene**

Aspect	Precautionary measures
Appropriate PPE	<ul style="list-style-type: none"> <li>• Mortuary staff and relatives should wear PPE (gloves, plastic aprons, gowns, protective eye wears, face masks covering mouths and noses, boots) when handling of dead bodies</li> <li>• Personal protective equipment should be removed after handling of the dead body, then wash hands with liquid soap and water immediately</li> <li>• Placement of boots and procedures for discarding or washing of clothing must be clearly designated.</li> <li>• Single use PPE must be disposed of as an infectious waste</li> </ul>
Instrument processing	<ul style="list-style-type: none"> <li>• All items must follow instruments processing procedures as laid down by National guidelines and procedures (decontamination, cleaning, high-level disinfection and sterilization)</li> </ul>
Body storage	<ul style="list-style-type: none"> <li>• Bodies should be stored in a functioning refrigerator and must be maintained at a temperature between 2 to 6°C.</li> <li>• If long-term storage is required, the body should be maintained at approximately -20°C</li> <li>• A body suspected of harbouring infectious diseases, decomposition, trauma or suspicious deaths should be contained within a body bag which is durable and impermeable to body fluids.</li> </ul>
Embalming chemicals	<ul style="list-style-type: none"> <li>• There should be embalming chemical (formalin) to temporarily prevent decomposition and restore a natural appearance of the body</li> </ul>



Aspect	Precautionary measures
Washing facilities	<ul style="list-style-type: none"> <li>Changing rooms with shower facilities must be provided in the mortuary</li> </ul>
Vaccination	<ul style="list-style-type: none"> <li>Hepatitis 'B' virus and TT vaccines should be provided to all mortuary staff</li> </ul>
Accidental exposure to blood or body fluids	<ul style="list-style-type: none"> <li>In case of percutaneous injury or mucocutaneous exposure to blood or body fluids of the dead body, the injured or exposed areas should be washed with copious amount of water</li> <li>All incidents of percutaneous or mucocutaneous exposure should be reported to the supervisor for proper wound care and post-exposure management</li> </ul>
Health Care waste management	<ul style="list-style-type: none"> <li>Items classified as HCW must be handled and disposed of according to colour coding as stipulated in the guidelines of HCWM</li> </ul>

## 7.8 Promotion of hygiene practices in health care facilities

Good hygiene practices are closely linked to hygiene behaviour change as an essential part of achieving infection prevention and control in health care facilities.

## 7.9 Approaches for promotion of hygiene practices in health care facilities

There are many approaches for promoting proper hygiene practices in health care facilities both among HCWs, patients and carers. However, the degree of adaptability depends on a number of factors including level of education of the patients or carers, customs, traditions and the level of commitment on the part of respective HCF management and staff. For the purpose of these guidelines the following approaches are recommended to be applied by HCFs so as to ensure that all HCWs, patients and carers progressively adapt proper hygiene practices in order to minimize the risks of transmission of diseases:

- (i) Make WASH a permanent agenda in HFCs Quality Improvement Team,
- (ii) Increase funding allocation for hygiene activities,
- (iii) Orientation to the HCF management on hygiene practices,
- (iv) Conduct continuing hygiene education to all departments for example, inpatient wards, Reproductive Child and Health Clinics (RCH), and at Outpatient Departments (OPD),
- (v) Provide information, education and communication, self-explanatory posters including SOPs on hygiene behaviours in ward walls, notice board and offices,
- (vi) Provide adequate WASH facilities.
- (vii) Ensure that proper hygiene practices are components of emergency response programmes,
- (viii) Developing strategies and tools to encourage hand-washing promotion by community health and outreach workers.

### REMEMBER:

*Hygiene practice will work effectively if there are adequate hygiene facilities in HCFs which are easily accessible.*

## 7.10 Sustaining hygiene practices in HCF

Each HCF should have an O&M strategy so that proper hygiene practices are maintained by staff, carers and patients and regularly monitored. The following hints will help HCFs to ensure good hygiene practices are maintained:

- (i) Conduct regular supportive supervision on matters related to hygiene. The template for O&M schedule is provided in Table 7.3.
- (ii) Prepare a checklist of issues which require regular monitoring



- (iii) Prepare a working schedule which will show who is responsible for cleanliness, when and how it will be conducted.
- (iv) Each HCF should, according to its working environment adopt a behaviour change and communication model which will be used by HCWs to educate client on behaviour change to improve people's behaviours on personal hygiene.

**Table 7.3: Template for O & M schedule for hygiene practices in health care facilities**

Activity	Responsible person	Frequency	Materials, fixture & fitting conditions	Material, tools & equipment needed for replacement
Cleaning surrounding areas of hand washing facilities				
Check whether taps are functioning and not leaking				
Check whether there is functioning liquid soap dispensers next to the hand washing facilities				
Check whether there is soap or detergent next to the hand washing facilities				
Refilling the soap dispenser				
Check cleanliness of toilets and bathrooms				
Check cleanliness and functionality of laundry facility				
Check cleanliness and functionality of kitchen				

## CHAPTER EIGHT

### 8.0 WASH SERVICES IN HEALTH CARE FACILITIES DURING EMERGENCY

#### 8.1 Rationale of WASH in health care facilities during emergencies

Emergency situations referred to in these guidelines are any emerging and re-emerging diseases that disrupt routine functioning of HCFs which need urgent or immediate attention. The disruption may lead to a total or partial suspension of WASH related services. These diseases include; Ebola, SARS, Rift Valley Fever, Marburg virus disease, Cholera, anthrax, Avian Influenza etc.

An overwhelmingly surge in the number of patients resulting from these incidences may significantly increase the risks of infection transmission specifically if there is inadequate water supply, sanitation facilities and hygiene to cope with the influx of the patients. Furthermore, HCFs may find themselves having insufficient numbers of staff to deal with control, cleaning, disinfection and waste collection requirements.

#### REMEMBER:

*Emergency situations happen within a short period of time with little or no prior warning and hence, a need for preparedness to respond to these eventualities.*

It is a common phenomenon for many HCFs to face challenges and difficulties in meeting the WASH needs during such emergencies mainly due to:

- (i) Lack of preparedness and mitigation response plans.
- (ii) Lack of collaborative primary assessment of the event in all hazard approach
- (iii) Lack of a proper emergency management framework

This chapter therefore, provides procedures in a stepwise manner to be implemented by the HCFs in collaboration with respective Councils, regional level government and other related organization such as humanitarian agencies, water supply and sewage authorities in addressing WASH issues during emergencies. It sets minimum WASH standards during emergencies regardless of type or size of HCFs in order to maintain their daily operations and patient care services. In other words, it is imperative for HCFs to have in place an emergency plan to respond to and recover from total or partial interruption of WASH services.

#### 8.2 Preparedness and response planning

The appropriate response to WASH in emergencies will depend on the nature of the emergency and the effectiveness of mitigation measures of the HCFs. This response will be largely determined by the availability of the appropriate response plan that has been validated through various simulations during preparedness phase. Hence, it is very much encouraged to have the response plan detailing roles and responsibilities of various sectors/actors involved.

#### 8.3 Conducting rapid assessment of WASH

A thorough needs assessment is crucial for informing authorities and different actors on the requirements and for a successful emergency response. The needs assessment results will inform the responsible authorities at national, regional, council and HCF levels of the priorities and the magnitude of the problems/impacts as well as on the needs requiring external support. In this regards, the WASH sub-committee in collaboration with other members from other SC will be responsible to carry out the needs assessment during emergency.

The WHO Rapid Assessment Tool (RAT) for WASH in HCFs in emergencies as presented in Annex 4 will guide the sub-committee to collect the data on the WASH needs during emergencies. This assessment will result in better understanding leading to good decision making done by the emergency managers.

## 8.4 Recommended guidelines for WASH in HCFs during emergencies

### 8.4.1 Priority response actions

In implementing the immediate emergency response actions, HCFs should aim at addressing the critical and priority needs resulting from an emergency. In this regard, they will be required to itemise the common priority needs depending on the nature of the emergency. First priority response actions should aim at reducing chances of:

- (i) Infections to health care workers who are providing services at the HCFs or designated emergency centres.
- (ii) Infections amongst the affected communities being attended at the HCF or in designated emergency centres.

### 8.4.2 Water supply

**Emergency water supply:** In determining how much water supply (quantity and quality) will be required during the emergency, the HCF should first carry out a water use audit which will involve:

- (i) Working out estimates of the quantity of water required to continue with operation of essential functions so as to meet the emergency demands as stipulated in these guidelines.
- (ii) Identifying which functions are essential to protect patients' safety and should remain in operation. This could include such functions as medical gas and ventilator if compressors are water cooled,
- (iii) Identify functions that can be temporarily restricted or eliminated (e.g. elective surgery, routine outpatient clinic visits) in the event of an interruption of the facility's water supply,
- (iv) Determining the steps required to restrict or eliminate some functions temporarily. For instance, this could include transferring of new acute patients to unaffected facilities,
- (v) Finding out any other available alternative water supplies,
- (vi) Identifying other emergency water storage measures.

**Water quantity:** HCFs must ensure that sufficient quantities of water are available to meet all the minimum daily requirements such as infection control and medical activities, drinking, laundry, bathing, hand washing, and cleaning. This may require interventions to repair the water supply or power supply if the water system requires power to function. It may also involve the installation of temporary water storage facilities such as demountable steel water tanks, bladder tanks or polyethylene tanks. Table 8.1 shows the recommended minimum water quantities during emergencies

**Table 8.1: Recommended minimum water quantities for HCFs in emergencies**

Users/ Area	Quantity of Water Required
Staff	5 litres/consultation
Outpatients	5 litres/consultation
Inpatient	40-60 litres/patient /day 15 litres/carer /day
Operating Theatre or Maternity Unit	100litres /intervention
Dry / Supplementary Feeding Centre	0.5–5 litres/consultation (depend on waiting time)
Wet Supplementary Feeding Centre	15 litres/consultation
Inpatient Therapeutic Feeding Centre	30 litres/patient/day 15 litres/carer/day
Cholera Treatment Centre	60 litres/patient/day 15 litres/carer/day
Acute Respiratory or Isolation Ward	100 litres/patient/day 15 litres/carer/day
Viral Hemorrhagic Fever Isolation Ward	300–400 litres/patient/day 15 litres/carer/day

**Source:** *Water, sanitation and hygiene in Health Care facilities in emergencies (WHO, 2012)*

**Water quality:** Infection control and prevention is of paramount importance in HCFs during emergencies. Except for water specifically prepared for specific medical purposes such as dialysis, all water supplies in the HCFs regardless of their use should therefore be treated with chlorine to drinking water standards. The purpose is to provide microbial safety in emergencies. In case the HCF is dealing with diarrheal epidemic, the level of residual chlorine should be increased to 1mg/l at end points. However, for other emergencies, the free chlorine residual after each contact time should be between 0.5 and 1.0mg/l.

Similarly, effective disinfection will require that water has a low turbidity. The median turbidity should be below 1 nephelometric turbidity unit (NTU). In emergency cases however, the turbidity level should not exceed 5-NTU otherwise water should be treated to remove suspended matter before disinfection.

**Sanitation services emergency control measures:** In times of emergencies the influx of clients in HCFs is likely to render the existing toilets unsanitary leading some users to resort to open defecation (OD). In order to rectify this situation HCFs should:

- (i) Maintain general cleanliness in and around toilets is maintained. This will be effective if the HCF increasing the number of cleaners and constant surveillance on the use of toilets.
- (ii) Construct additional toilets when required.
- (iii) Conduct hygiene sensitisation/educational awareness to clients on the importance of use of toilet and maintaining free from human excreta as well as proper hand washing after toilet use and patient care.
- (iv) Temporary emergency facilities should be provided with temporary toilets such as trench/pit latrines at the beginning of an emergency or disease outbreak.
- (v) Construct improved toilets if the outbreak persists for more than 21 days.

**Table 8.2: Essential emergency control measures in health care facilities**

Effect suspected	Control measures
Excreta disposal	<ul style="list-style-type: none"> <li>• Provide sufficient numbers of staff toilets for both male and female</li> <li>• Provide sufficient toilets for patients and carers for both male and female</li> <li>• Provide toilets for people with special needs for both male and female</li> <li>• Avoid contamination of water sources</li> <li>• Provide sound drainage system</li> </ul>
Wastewater disposal	<ul style="list-style-type: none"> <li>• Dispose properly wastewater from hand washing facilities, bathing, cleaning and laundering</li> <li>• Provide sound drainage system</li> <li>• Provide properly functioning septic tanks and soakage pit or public sewer</li> </ul>
Storm water management	<ul style="list-style-type: none"> <li>• Design storm water drainage to prevent carrying potentially infectious material away from the health care facility into the community</li> <li>• Frequently clean storm water drainage to avoid blockage</li> </ul>
Health-care waste management	<ul style="list-style-type: none"> <li>• Safely segregate, store, collect, transport, treat and dispose of health-care waste.</li> <li>• Provide adequate coloured coded containers with liners and covers for health care waste segregation.</li> <li>• Provide HCWs with appropriate personal protective equipment.</li> <li>• Construct a fence around HCF collection point</li> <li>• Empty collection bins whenever necessary</li> <li>• Orient/ re-orient HCWs on health care waste management</li> </ul>

**Ratio of users per Stance:** It is inevitable that due to the influx of people during the emergency the number of toilet units cannot remain one unit per 20 users as recommended in normal situation.

**Inpatient settings:** If the HCF experiences a rapid increase in the number of patients or other temporary facilities are being installed as a response to the emergency, the initial planning should target for one stance per every 20 to 25 users. However, in case a large number of patients are using bed pans the number of stances can be rationalized accordingly. It is recommended that the number of female to male stances should be 2:1

**Outpatient settings:** The number of toilets will vary from one HCF to another with larger outpatient settings having more toilets than smaller ones. The recommended ratio should be two separate toilets for staff (for female and male users), one for female patients, one for male patients, and two for children (one for female and another for male children).

**Toilets for people with special needs:** These include toilet users who are very sick, under five children, pregnant women, elderly, or physically handicapped. HCFs should reserve at least one emergency toilet for each of these people (one toilet for male and female users).

**Signposting:** All toilets should be signposted to help users to find them much easier and to avoid interference of users.

#### **8.4.3 Personal Protective Equipment (PPE)**

The provision of PPE is of paramount significance to all HCWs involved in the mitigation process in order to keep them safe against the established threat. The PPE might empower and give them the needed capacity and capability in saving lives and environment at large. Various PPE might be needed depending on the nature of the event/emergency, they include gloves, gowns, boots, masks, goggles and other various incident related materials that are known to confer effective protection in the restoration of WASH services.

#### **8.5 Establishing of operational monitoring system**

A key requirement in identifying control measures is that their performance can be monitored. Thus, operational monitoring procedures should be established for each newly identified or existing control measure. Operational monitoring is used to assess the performance of individual control measures to ensure that they are working effectively, as designed. Monitoring frequencies should be compared with the established target in the response plan to ensure the corrective actions are mounted timely to prevent loss of lives and environment. Monitoring should not only be established quantitatively but also qualitatively accomplished to effectively mitigate the event adversary by doing:

- (i) Simulation/exercise
- (ii) After action review
- (iii) Assessment report

During the response, the coordinating body may ask actors to provide them with frequent (weekly, bi-monthly, monthly – depending on the nature of the response) reports on key WASH indicators so they can track the progress of the overall WASH in health-care facilities response.

## CHAPTER NINE

### 9.0 LANDSCAPING AND VECTOR/VERMIN CONTROL

The preceding chapters focus mainly on improvement of WASH services in HCFs. However, this chapter deals with two other critical aspects related to environmental cleanliness and control of diseases within the HCFs namely landscaping and vector/vermin control. These guidelines will help HCFs to ensure that the environment is kept attractive and appealing to staff and clients at the same time minimizing risks of acquiring vector/vermin borne diseases.

#### 9.1 Landscaping, gardening and outdoor spaces

Landscaping on one hand, refers to activities that aim at modifying or altering the visible features of land within and around the HCF so that it may become more attractive by adding ornamental features and or planting trees. On the other hand, gardening refers to the act or craft of growing plants, flowers or special shrubs with a purpose of creating a beautiful environment within the HCF landscape. Attractive outdoor environment in HCFs is said to have psychological and social positive impacts on both HCWs, patients and carers.

In other words, outdoor spaces play a critical role in the creation of dignified environments for treatment and infection control. Landscape should be considered and integrated into any facility design to produce well-planned exterior environment. Durable and appropriate furnishing can be easily integrated into the landscape approach to create comfortable and low cost outdoor gathering areas that contribute to infection control as well as staff and patient comfort.

#### 9.2 Basic considerations in planning for outdoor environment of health care facilities

When planning for outdoor environment, HCFs should take into account the following issues in order to create the environment attractive (see Figure 9.1):

- (i) Landscape should be designed in conjunction with covered waiting areas, taking into account proximity of waiting areas to check-in and diagnostic consultation rooms
- (ii) Each HCF should designate special room for storing out of order hospital equipment and furniture
- (iii) Playing areas for recovering children or those accompanying sick parents—especially long-term patients should have access to the outdoors, sunshine, and opportunities for play to support improvements in health. In addition care should be taken to ensure that playing areas are safe and comfortable for both children and their carers.
- (iv) Planting of trees and flowers should be used as strategy for providing shade, air purification, dust control, and noise pollution buffering. In each case design strategy should adhere to basic design principles for instance consideration of wind direction, sun rise and sun set directions as well as noise barriers.
- (v) HCF management team should consult horticulture officers for selection of appropriate planting of trees and flowers for gardening and other purposes. Use of local climate friendly, allergy free and native trees is highly encouraged.
- (vi) HCFs should allocate and mark a space for parking transport facilities e.g. bicycles, motorcycles and vehicles. The design should consider proper traffic or circulation patterns for vessels and pedestrians. Directing traffic patterns e.g. KEEP LEFT or DO NOT HOOT etc. should be clearly marked.
- (vii) All boundaries of the Health Care facilities should be known and secured by fencing.
- (viii) Cleaning of gardens including drainage should be done on daily basis.
- (ix) HCFs should be fenced for security, keeping out stray dogs and cats as well as limit tress passers who could otherwise damage the landscaping and ruin efforts made to improve outdoor environment and amenity.
- (x) Walk ways should be appropriate for each area of a facility and the expected patient load in that area. The recommended path sizes are 3', 4' and 8' for tertiary, secondary and primary paths respectively.



- (xi) Walk way material should be impermeable where adjacent to buildings or beneath covered verandas and permeable when there is landscape on both sides.
- (xii) All paths should be well drained, accessible to handicap individuals and provided with handrails where needed.
- (xiii) Every HCF should have an overall site plan of the entire area.



*Pictures: Courtesy Mr. Anyitike P. Mwakitalima*

**Figure 9.1: Examples of landscaping and gardening in health care facilities**

### 9.3 Operational and maintenance

The following actions should be taken in order to maintain the neatness of HCF's surroundings;

- (i) Cleaning of gardens and drainage on daily basis
- (ii) HCFs fences should be well maintained leaving no chance for stray animals such as dogs and cats or trespassers to enter the HCF premises.
- (iii) All damages on the landscape should be identified timely and measures taken immediately to repair them.
- (iv) All wastes should be disposed of properly
- (v) Obsolete furniture and appliances should be stored properly prior being disposed of properly.

### 9.4 Vector and vermin control

Vector and vermin control is an important aspect in the prevention of majority of diseases in HCFs. Vector/vermin controls works more effectively when integrated approach is applied. Table 9.1 provides approaches for control of selected common vector and vermin in HCFs.

#### **NOTE:**

*Fumigation/indoor residual spray should be done at least every six months in order to eliminate vermin and vector. Also HCFs should ensure that only registered pesticides are used during fumigation.*

*Before applying vector or vermin control measures, conduct a survey to determine the extent of infestation as a baseline information.*

**Table 9.1: Vector /vermin control measures**

S/No	Vector /vermin	Control measures
1	BATS	Use bat proofing as a best long term solution for excluding bats from buildings.
		Provide tight fitting, weather stripping, windows screen, and chimneys covered with hardware cloth screens and ensure there is a colony inhabiting a roof space or wall at dusk to locate the entry or exit holes.
		Seal openings with screening or insulation.
		Use a piece of bird netting of 1/16 inch or smaller mesh, at least 2ft wide, fixed above the bat entry extending at least two feet below the exit.
		Use light bulb in areas where bats reside as bats tends to escape from light.
		Roofing of health facilities should be accompanied with clear polycarbonate roofing sheets or transparent roofing sheets
		Use naphthalene beads or pellets to repel
2	BED BUG	Maintain cleanliness in all health facility setting
		Provide clothes to all in patients (IPD)
		Use insect repellents or insecticides (malathion, lindane)
		Plaster/ re-plaster cracked walls.
3	HOUSE FLIES	Reduce sources that attract flies from other areas eg through proper garbage management
		Use fly proof screen with plastic coating and openings of 1.5 mm or less
		Use Organophosphorus compounds such as diazinon, fenchlorphos, Malathion, fenthion, dimethoate and trichlorfon; carbamates such as propoxur dimetilan; and pyrethroids such as cypermethrin, deltamethrin, permethrin and cyfluthrin are recommended toxicant to be used in killing houseflies.
S/No	Vector to be controlled	Control measures
1	HOUSEFLIES	Attract flies with toxic baits(attractant) by using milk or sweet liquids with 1–2% formaldehyde or use organophosphorus and carbamates compounds that are highly toxic to kill flies
		Dip diluted emulsion of insecticide with some sugar, glycerol or other attractant and glue or oil and place the emulsion on house fly resting sites.
2	MOSQUITOES	Conduct social participation by motivating personal and family protection, health education and community involvement and participation
		Remove all long grasses around the HCF, dispose all stagnant water
		Conduct daily and weekly environmental cleanliness
		Dispose any item likely to cause outdoor water stagnation.
		Conduct biannually indoor residual spraying by using pyrethroid lambda-cyhalothrin (ICON 10 CS) and ultra-low volume sprays.
		Reduce human-mosquito contact by using insecticide mosquito nets and window mosquito screening.
		Destruct mosquito larvae by peri-domestic sanitation and conduct larviciding of water surfaces, intermittent irrigation and sluicing.

S/No	Vector /vermin	Control measures
3	TERMITE	Conduct monthly termite inspection in the HCF premises to determine any presence of infestation
		Treat the soil around and beneath the building with termiticide
		Don't store firewood, lumber, or other wood debris against the foundation or inside the crawl space.
		Use wood or laminated texture-flavored cellulose, impregnated with a toxicant and/or insect growth regulator.
		Discourage termite attacks, by building with metal termite shielding and the shielding should extend at least 2 inches out and 2 inches down at a 45° angle from the foundation wall
		Ensure proper drainage and repair of plumbing to prevent moisture of HCF building foundations
		The recommended insecticide for termite control is GLADIATOR 4 TC
4	COCKROACHES	Reduce sources that attract cockroaches from other areas e.g. through proper garbage management
		Eliminate habitat and prevent entry and maintaining hygiene in food stores and kitchen
		Use of insecticides and traps
5	RATS	Maintain proper sanitation including waste management
		Eliminate habitat and prevent entry
		Use rodenticides to kill rats and other similar rodents which harbor fleas.
		Use pyrethroids, such as permethrin, to kill adult fleas, and pyriproxyfen (Nylar Archer), and methoprene (Precor), to suppress flea eggs, larvae and pupae.
6	PETS	Fencing of HCFs
		Kill stray dogs/cats
		Prohibit entry of pets

**NOTE:**

*Mixing concentration for fumigation/ indoor residual sprays commodities should follow manufacturer's specifications*

## CHAPTER TEN

### 10.0 MONITORING OF WASH IN HEALTH CARE FACILITIES

#### 10.1 Introduction

This chapter provides guidance on how to prepare and conduct monitoring of the implementation of WASH interventions in health care facilities. It accounts the rationale for conducting monitoring, indicators to be monitored. In addition, the chapter provides the tools to be used for collecting data during monitoring activities at different level of facilities. Further timeline for data collection and responsible persons are detailed as well as steps for data quality management, reporting and development of monitoring plan.

#### 10.2 Why monitoring of WASH services in health care facilities-

The primary objective of monitoring WASH services in HCFs is to measure the extent to which the set guidelines (i.e. minimum WASH standards in HCFs) are adhered to and identify areas for remedial actions. Through the process of monitoring key stakeholders at different levels, community, HCF, Council, regional and national levels will be informed of the WASH status and actions needed for improvement. The periodic feedback on the WASH status in HCFs is critical in making informed decisions aimed at maintaining improved WASH in health care facilities in the country.

In this context, monitoring will involve:

- (i) Measuring the level of adherence by the HCFs in maintaining the minimum standards of WASH services as prescribed in these guidelines
- (ii) Identifying any shortfalls in the O&M of WASH facilities
- (iii) Alerting actors at different levels of the needed remedial actions either in the design or construction of the WASH facilities

#### 10.3 What to monitor?

Monitoring of WASH in HCFs will be a regular and continuing function that will primarily aim at providing the HCF health management teams and other stakeholders with information on the provision of minimum standards of WASH services. In order to achieve this, several indicators have been developed to guide the monitors on what they should look for during the process. In this regards, indicators have been developed around the key aspects of WASH namely, water availability and accessibility, adequate accessibility of sanitation and hygiene facilities as well as vector/vermin control systems in HCFs.

#### 10.4 Who monitors and when?

Institutionally, the health sector at all levels is responsible for monitoring and following up of implementation and progress as well as status of WASH services in all HCFs in the country. However, in order to ensure ownership of the process a bottom-up participatory approach will be adopted in accessing the data, starting from HCFs themselves to district, regional and eventually through national level.

WASH monitoring will therefore be undertaken at five levels namely, HCF, ward, district, regional and central or national level. In this way monitoring teams will be structured in a cascading manner from the HCF to the national level. Thus, the process will require different actors as presented in Table 10.1.

**Table 10.1: Actors involved in monitoring of WASH in HCFs**

Level	Involved Actors	Specific Monitoring/Follow up Tasks
HCF Level	<ul style="list-style-type: none"> <li>• In charge of HCF</li> <li>• Designated health care staff and estate manager</li> <li>• Health facility management team</li> <li>• Community Health Workers (CHWs)</li> <li>• Health Facility Governing Committees (HFGCs)</li> </ul>	<ul style="list-style-type: none"> <li>• Establish in-house routine monitoring and follow up of WASH services within HCF and implementation of remedial actions e.g. repairs and maintenance of WASH facilities</li> <li>• Coordinate monitoring process within HCFs</li> <li>• Collect data using the provided tools</li> <li>• Submission of collected data to WEHO for validation</li> <li>• Provision of health education during home visits regarding WASH</li> <li>• Fund approval and allocation of non-professional operations</li> </ul>
Ward Level	<ul style="list-style-type: none"> <li>• WEHO</li> <li>• WEO</li> <li>• Health Facility Governing Committees</li> </ul>	<ul style="list-style-type: none"> <li>• Coordinate the monitoring process in HCFs within the ward</li> <li>• Carry out periodic monitoring of the WASH services in HCFs within the ward</li> <li>• Validate and compile/consolidate collected data from HCFs and forward to DMO</li> <li>• Responsible for all operations in the facility</li> </ul>
LGA Level	<ul style="list-style-type: none"> <li>• DMO</li> <li>• DHO</li> <li>• NSMIS FP</li> <li>• MTUHA Coordinator</li> <li>• DNO</li> <li>• DHS</li> <li>• DWE</li> <li>• Health Facility Management Teams (HFMT)</li> <li>• Council Health Service Boards</li> </ul>	<ul style="list-style-type: none"> <li>• Provide oversight of the monitoring activities in all HCFs within the district/municipality/city</li> <li>• Compile collected data from all HCFs in the district and submit the same to RHO</li> <li>• Make periodic follow up visits to HCFs within the district/municipality/city to monitor WASH status</li> <li>• Oversee all operations in the hospital</li> <li>• Oversee health services provided by the Health facilities in the council</li> </ul>
Regional Level	<ul style="list-style-type: none"> <li>• RMO</li> <li>• RHO</li> <li>• RNO</li> <li>• RWE</li> <li>• MTUHA FP</li> <li>• NSMIS FP</li> <li>• Regional Referral Service Boards (RRHBs)</li> </ul>	<ul style="list-style-type: none"> <li>• Establish a team for overseeing data collection on WASH status in all HCFs within the region</li> <li>• Provide oversight on the monitoring process of WASH status in HCFs within area of administration</li> <li>• Validate and compile collected data for submission to MoHCDGEC through PO-RALG</li> <li>• Oversee health services in the regions</li> </ul>

Level	Involved Actors	Specific Monitoring/Follow up Tasks
National Level	<ul style="list-style-type: none"> <li>• MoHCDGEC</li> <li>• PO-RALG</li> <li>• MoWI</li> <li>• DPs</li> </ul>	<ul style="list-style-type: none"> <li>• Design, refine and review national monitoring framework for WASH in HCFs</li> <li>• Define monitoring indicators and standards of WASH in HCFs</li> <li>• Store national WASH in HCFs performance data from different LGAs and regions</li> <li>• Provide technical advice to LGAs and RSs on monitoring and follow up process of WASH in HCFs</li> <li>• Review monitoring reports from LGAs/RSs</li> <li>• Undertake periodic visits for quality assurance of monitoring process</li> <li>• Organize national review meetings for key stakeholders</li> <li>• Compile/aggregate data on national level WASH status in HCFs</li> </ul>

### 10.5 Reporting

Reporting of progress in the implementation of WASH in HCFs should be done monthly by the different actors at different levels in the following manner:

#### 10.5.1 Ward level

Ward level Health Officers should submit reports from all HCFs from their catchment areas and submit to the NSMIS where computer and internet is available.

#### 10.5.2 Council level

The team should verify the data in the system and against the hard copies submitted by Hospital or Ward Level Officer. For the case of offline data submitted by Hospital or Ward Level Officer the Focal Person shall enter the data into the NSMIS.

#### 10.5.3 Regional level

RHO shall review the councils' reports and send narrative summary of the regional consolidated report to PO-RALG and copy MoHCDGEC, MoWI by the fifteenth day of the first month of the following quarter using the reporting form for the RS.



## REFERENCES

- Anna Charkowska, 2008, *Ensuring Cleanliness in Operating Theatres*, International Journal of Occupational Safety and Ergonomics (JOSE) Vol. 14, No. 4, 447–453.
- Ben Taylor, 2009, *Situation Analysis of Women, Children and the Water, Sanitation and Hygiene Sector in Tanzania*, Version for Discussion at the Joint Water Sector Reviews, Draft 5.3.
- Benova, L, Cumming O, Gordon B.A, Magoma A, Campbell O.M, 2014, *Where there is no toilet, water and sanitation environments of domestic and facility births in Tanzania PloS one*, 9(9), e106738.
- Fidelis Paul and Marko J. Msambazi and reviewed by Bethlehem Mengistu, 2012, *Fact Sheet on Sanitation Financing*, WaterAid Tanzania.
- Hari J. Krishna, 2005, *The Texas Manual on Rainwater Harvesting*, 3<sup>rd</sup> edn, Texas Water Development Board, USA.
- Janne Brigs, Wonder Goredema, Terry Green, Mohan P. Joshi and Mupela Ntengu, 2013, *Infection Control Self-Assessment Tool for Primary Health Care Facilities*, USAID and SIAPS.
- John Adams, Jamie Bartram, Yves Chartier (eds), 2008, *Essential Environmental Health Standards in Health Care*, World Health Organization, Geneva, Switzerland.
- John Adams, Yves Chartier, Ben Harvey and Dominique Maison (eds), 2012, *Water, Sanitation and Hygiene (WASH) in Health Care Facilities in Emergencies*, World Health Organization, Geneva, Switzerland.
- John M. Boyce and Didier Pittet, 2002, *Guideline for Hand Hygiene in Health-Care Settings: Morbidity and Mortality Weekly Report: Centers for Disease Control and Prevention*, US Department of Health and Human Services, Atlanta, USA.
- Kaposo Boniface Mwambuli, 2015, *Enabling Sanitation and Hygiene Performance Review - Sanitation Monitoring Handbook for Households and Institutions: Tanzania Mainland*, Water and Sanitation Program/ WB Report.
- Li Liu, Shefali Oza, Daniel Hogan, Jamie Perin, Igor Rudan, Joy E Lawn, Simon Cousens, Colin Mathers, Robert E Black, 2014, *Global, Regional and National Causes of Child Mortality in 2000-2013 with Projections to Inform Post 2015 Priorities-an Updated Systematic Analysis*, found on <http://www.who.int/immunization/diseases/tetanus/Lancet-2013-Global-child-mortality.pdf>.
- Linda Strande, Mariska Ronteltap and Damir Brdjanovic (eds), 2014, *Faecal Sludge Management – Systems Approach for Implementation and Operation*, IWA Publishing.
- Malebo H., 2015, *Water, Sanitation and Hygiene: Situation in Health Care Facilities in Tanzania Mainland and Way Forward*.
- Ministry of Health, and Water & Energy (Ethiopia) and UNICEF support, *Design and Construction Manual for Water Supply and Sanitary Facilities in Health Institutions*.
- National Institute of Medical Research (NIMR), 2016, *Water Sanitation and Hygiene Situation in Health Care Facilities in Tanzania Mainland and Way Forward*.

Oliver Schmoll, Guy Howard, John Chilton and Ingrid Chorus (eds), 2006, *Protecting Groundwater for Health - Managing the Quality of Drinking-water Sources* published on behalf of WHO by IWA Publishing.

Royal College of Physicians of Ireland, 2015, *Guidelines for Hand Hygiene in Irish Health Care Settings*, Royal College of Physicians of Ireland.

Sepideh B. N., Allegranzi B., et al., 2011, *Health Care Associated Infection in Africa: A systematic Review*, World Health Organization, Oct 1: 89 (10), 757-765.

SIMAVI, 2014, *Upgrading Health Facilities in Dodoma region, Tanzania*, Dutch WASH Sector, The Hague, The Netherlands.

Simonsen L., Kane A., Lloyd J., Zaffran M., Kane M., 1999, *Unsafe injections in the developing world and transmission of blood borne pathogens: a review*, [Bulletin of World Health Organization](#), 77(10):789-800 (ISSN: 0042-9686).

Stephan Simon, 2013, *Orientation Framework – Water, Sanitation and Hygiene: Storm Water Management, Best Management Practices (BMPs) the fact sheet was prepared as part of the Rouge River National Wet Weather Demonstration Project*, USEPA grant #X995743-02 found on [http://www.michigan.gov/documents/deq/ess-nps-savvy-bmp\\_209386\\_7.pdf](http://www.michigan.gov/documents/deq/ess-nps-savvy-bmp_209386_7.pdf).

Tanzania Bureau of Standards (TBS), 2007, *National Environmental Standards Compendium*

Terry Hart and Dr. Nitant Mate, 2004, *Managing Health Care Waste Disposal: Guidelines on How to Construct, Use and Maintain a Waste Disposal Unit*, IT Power India Private Limited, India.

Terry Hart and Nitant Mate, 2004, *Managing Health Care Waste Disposal: Guidelines on How to Construct, Use, and Maintain a Waste Disposal Unit*, IT Power India Private Limited (ITPI) Publication for PATH's Children's Vaccine Program (CVP), prepared by the WHO, Africa Region, Harare – Zimbabwe.

Velleman Y, Mason E, Graham W, Benova L, Chopra M, Campbell OMR et al. 2014, *From joint thinking to joint action: A call to action on improving water, sanitation, and hygiene for maternal and newborn health*. PloS Medicine; 11(12): e1001771

UNICEF, WHO, WaterAid, *Water, Sanitation and Hygiene in Health Care Facilities in Asia and the Pacific – a necessary step to achieving universal health coverage and improving health outcomes* found on [www.wateraid.org/bd/~media/Publications/WASH-in-health-care-facilities-in-Asia-and-the-Pacific.pdf](http://www.wateraid.org/bd/~media/Publications/WASH-in-health-care-facilities-in-Asia-and-the-Pacific.pdf).

United Republic of Tanzania, Ministry of Health, 2012, *National Infection Prevention and Control Standards for Hospitals in Tanzania – Standards-Based Management and Recognition for Improving Infection Prevention and Control Practices – an Assessment Tool prepared by Jhpiego*.

United Republic of Tanzania, Ministry of Health and Social Welfare, 2001, *District Health Management Training – Module One: Health Sector Reforms and District Health Systems*, 2<sup>nd</sup> edn.

United Republic of Tanzania, Ministry of Health and Social Welfare, 2005, *The National Environmental Health, Hygiene and Sanitation Strategy, NEHHSAS 2006-2015*.

United Republic of Tanzania, Ministry of Health and Social Welfare, 2011, *Sanitation and Hygiene Policy*.

- United Republic of Tanzania, Ministry of Health and Social Welfare, 2016, *National Standards and Procedures for Health Care Waste Management*.
- United Republic of Tanzania, Ministry of Water, 2009, *The Water Resources Management Act*.
- United Republic of Tanzania, Ministry of Water and Irrigation, 2009, *Design Manual for Water Supply and Waste Water Disposal, 3<sup>rd</sup> Edition*.
- United Republic of Tanzania, Ministry of Water and Irrigation, 2014, Water Sector Development Programme II; 2016-2021.
- United Republic of Tanzania, Ministry of Water and Livestock Development, 2002, *National Water Policy*.
- United Republic of Tanzania, Ministry of Water and Livestock Development, 2002, *Water and Sanitation in Tanzania – Poverty Monitoring for the Sector Using National Surveys*.
- USAID, 2011, *Tanzania Health System Assessment 2010 Report*, United State Agency for International Development and Health 2020 Systems.
- USAID/SIAPS, 2013, *Infection Control Self-Assessment Tool for Primary Health Care Facilities*, System for Improved Access to Pharmaceutical and Services (SIAPS).
- Velleman Y, Mason E, Graham W, Benova L, Chopra M, Campbell OMR, et al., 2014, *From Joint Thinking to Joint Action: A Call to Action on Improving Water, Sanitation, and Hygiene for Maternal and Newborn Health*. PLoS Med 11(12): e1001771 found on <https://doi.org/10.1371/journal.pmed.1001771>
- WaterAid, 2012, *Hand Hygiene in Health Care Facilities*.
- WaterAid, 2015, *'Its no Joke': The state of the World's Toilets*.
- WaterCan Canada, 2011, *WaterCan Minimum Standard Guidelines for WASH Services*.
- WHO, 2002, *Prevention of Hospital Acquired Infections - a Practical Guide, 2<sup>nd</sup> edn*, World Health Organization; Geneva, Switzerland.
- WHO, 2007, *Epidemic and Pandemic Alert and Response*, World Health Organization; Geneva, Switzerland.
- WHO, 2008, *Essential Environmental Health Standards in Health Care Facilities*.
- WHO, 2009, *Guidelines on Hand Hygiene in Health Care – First Global Patient Safety Challenge, Clean Care and Safer Care*, published by the World Health Organization, Geneva, Switzerland.
- WHO, 2009, *WHO Guidelines on Hand Hygiene in Health Care*, World Health Organization, Geneva, Switzerland.
- WHO, 2012, *Water, Sanitation and Hygiene in health care facilities. Status in low and middle-income countries*, World Health Organization; Geneva, Switzerland.
- WHO, *Guiding Principles to Ensure Injection Device Security* found on [http://www.who.int/injection\\_safety/WHOGuidPrinciplesInjEquipFinal.pdf](http://www.who.int/injection_safety/WHOGuidPrinciplesInjEquipFinal.pdf) (last visited on 2 September, 2016).

WHO, UNICEF & Share, 2016, *Water, Sanitation and Hygiene in Health Care Facilities – Global Strategy, Burden of Disease and Evidence and Action Priorities, Workshop Report*.

WHO, UNICEF, 2016, *Expert Group Meeting on Monitoring WASH in Health Care Facilities in the Sustainable Development Goals, Meeting Report*, World Health Organization; Geneva, Switzerland.

WHO/UNICEF Report, 2015, *Water, Sanitation and Hygiene in Health Care Facilities: Status in Low- and Middle-Income Countries and Way Forward – Question and Answers*, World Health Organization; Geneva, Switzerland found on [http://www.who.int/water\\_sanitation\\_health/publications/qa-wash-hcf.pdf](http://www.who.int/water_sanitation_health/publications/qa-wash-hcf.pdf) (last visited on 7 December, 2016).

WHO/UNICEF, 2015, *Global Action Plan on WASH in Health Care Facilities Summary* found on [http://www.who.int/water\\_sanitation\\_health/healthcare\\_waste/wash-in-healthcare-facilities-action-plan.pdf](http://www.who.int/water_sanitation_health/healthcare_waste/wash-in-healthcare-facilities-action-plan.pdf), (last visited on 19 October, 2016).

## ANNEXES

### ANNEX 1: RECOMMENDED NUMBER OF HAND WASHING FACILITIES PER LEVEL OF FACILITY AND LOCATIONS

S/ N	Health Care Facility level	Location of hand washing facility in the HCF	Number of hand washing basins	
1	Dispensary	OPD consultation room	8 (1 in each section)	
		Injection room		
		RCH section		
		Pharmacy		
		Laboratory		
1	Dispensary	Dressing room	8 (1 in each section)	
		Labour room		
		Sluice room		
		Patient toilets (Male and female)		2 (1 in each toilet)
		Staff changing including shower and wash room (male and female)		2 (1 in each toilet)
2	Health Centre	Patient toilet for disabled (Male and female)	2 (1 in each toilet)	
		2 OPD consultation rooms, Laboratory, Dressing room, Injection room, Labour room, Eye care, Dental section, RCH section, Care and Treatment Clinic, Mortuary, Pharmacy and Sluice room	13 (1 per each section or room)	
		Inpatient department (IPD) (male and female wards)	2 (1 per each ward)	
		Public toilets (Male and female) for normal people	2 (1 per each toilet)	
2	Health Centre	Public toilets (male and female) for disabled	2 (1 per each toilet)	
		Staff changing including shower and wash room (male and female)	2 (1 per each toilet)	

S/ N	Health Care Facility level	Location of hand washing facility in the HCF	Number of hand washing basins		
3	Hospital	OPD consultation rooms, Laboratory, Dressing room, Injection room, Labour room, Eye care, Dental section, RCH section, CTC, Theater, Nutrition room, Mental Health (psychiatric) section, Central sterilization and supplies room, Pharmacy, Mortuary and sluice room	Minimum: 19 Maximum: 19+ depending number OPD rooms for clinicians (1 per each section/ room)		
		Inpatient department (IPD) (male and female wards) Internal medicine Surgical ward Obsy/ Gyne ward Paediatric ward	6 (2 per each)		
		Patient toilets (Male and female)	2 (1 per each toilet)		
		Labour ward	1		
		Catering area	2		
		Patient toilet for disabled	1 (for both sex)		
		Staff changing including shower and wash room (male and female) of labour ward, internal medicine, Obsy/ gyne, paediatric, OPD and surgical ward	9 (1 Hand washing per each changing room should be provided adjacent to WC)		
		4	Referral Hospitals	ODP consultation rooms, laboratory, dressing room, injection room, labour room, eye care, dental section, RCH section, CTC, Theater, Nutrition room, Mental Health (psychiatric) section, Central sterilization and supplies room, Pharmacy, Mortuary and Sluice room	Minimum: 20 Maximum: 20+ depending number OPD rooms for clinicians (1 per each section/ room)
				Inpatient department (IPD) (male and female wards) Internal medicine Surgical ward Obsy/ Gyne ward TB ward Postnatal ward	9
Patient toilets (Male and female)	2 (1 per each toilet)				
Patient toilet for disabled (male and female)	2 (1 per each toilet)				
Labour ward	1				
Neonatal ward,	1 (for Neonatal)				
Intensive Care Unit (ICU)	1+ (for ICU)				
Catering	2				
Staff changing including shower and wash room (male and female) of OPD section, Labour ward, Internal medicine, Obsy/ gyne, paediatric, TB ward, Postnatal ward and surgical ward	12 (1 Hand washing per each changing room should be provided adjacent to WC)				
Administration (Facility in charge, Matron and Patron)	3 (1 for each room)				



## ANNEX 2: HAND WASHING BASIN PROVISION FOR SPECIALIZED/ CONSULTANT HOSPITALS

Location (Directorate/ Department/section)	N <sup>o</sup> . of hand washing basins
<b>MEDICAL DEPARTMENT</b>	
<b>OPD</b>	
Causality/ Emergency	18
ICU	13
Internal medicine	19
CTC services (TB/HIV)	2
Pediatric clinic	12
Physiotherapy	4
Psychiatric clinic	6
Staff washroom/ bathroom (male and female)	2
OPD pharmacy	1
Super specialty services	21
General medicine	15
Nutrition centre	1
Phlebotomy room	1
<b>SURGICAL DEPARTMENT</b>	
8 Surgical wards + 8 washroom	16
2 staff bathroom/wash room (male/ female)	2
Emergency medicine theatre	6 (2 in the theatre, 4 in the office)
ENT Clinic (with 3 offices)	3
<b>Oral Health Clinic</b>	
Radiograph	1
Dental room	2
Specialist room	4
<b>OPD Eye Clinic</b>	
Ophthalmologist room	4
Other offices	4
<b>Anaesthesia services</b>	
7 Service rooms	7
<b>CLINICAL SUPPORT SERVICES DIRECTORATE</b>	
Haematology	1
Microbiology/ immunology	1
Parasitology/ Entomology	1
Clinical chemistry	1
Histopathology/ Cytology	1
Mortuary	1
Administrative pathologist	1
Radiology (X-ray, ultrasound)	1
Special X-ray	1
Infusion	1
Pharmacy	2

## ANNEX 3: REQUIREMENTS AND SPECIFICATIONS OF BATHROOMS

S/N	Level of health facility	Provisions	Location	Description (Number/ User)	Specifications as per user	
					Urban	Rural
1	Dispensary	Shower room Soap dish Towel/cloth Hanger Water supply Water heater Gall trap Sitting facility Soap	Delivery room	1 (for delivering mothers)	<p>Shower: <b>Overhead shower</b></p> <p>Shower tap: <b>Mix tap -cold/ hot water</b></p> <p>Soap dish: <b>Plastic</b></p> <p>Hanger: <b>Stainless steel</b></p> <p>Room size: <b>Width 150cm x Length 200cm</b></p> <p>Water quality: <b>Adequate, Gall trap: Plastic at the bath floor</b></p> <p>Sitting chair: <b>bed like (flexible) with smooth washable materials</b></p> <p>Water heater: <b>Electrical heater</b></p> <p>Wall/ floor materials: <b>Tiles</b></p>	<p>Shower: <b>Hand shower or clean bucket and small jug</b></p> <p>Shower tap: <b>Mix tap –cold/ hot water</b></p> <p>Soap dish: <b>Plastic</b></p> <p>Hanger: <b>Stainless steel</b></p> <p>Room size: <b>Width 150cm x Length 200cm</b></p> <p>Water quality: <b>Adequate, Gall trap: Plastic at the bath floor</b></p> <p>Sitting chair: <b>bed like (flexible) with smooth washable materials</b></p> <p>Water heater: <b>Electrical heater/ Cooker</b></p> <p>Wall/ floor materials: <b>Tiles/ cement</b></p>

S/N	Level of health facility	Provisions	Location	Description (Number/ User)	Specifications as per user	
					Urban	Rural
2	Health Centre	Shower room Soap dish Towel/cloth Hanger Water supply  Water heater Gall trap Sitting facility Soap	Delivery room	1  (for delivering mothers)	Shower: <b>Overhead shower</b> Shower tap: <b>Mix tap- cold/ hot water</b> Soap dish: <b>Plastic</b> Hanger: <b>Stainless steel</b> Room size: <b>Width 150cm x Length 200cm</b> Water quality: <b>Adequate,</b> Gall trap: <b>Plastic at the bath floor</b> Chair: <b>bed like (movable and flexible) with smooth washable materials</b> Water heater: <b>Electrical heater</b> Wall/ floor materials: <b>Tiles</b>	Shower: <b>Hand shower or clean bucket and small jack</b> Shower tap: <b>Mix tap - cold/ hot water</b> Soap dish: <b>Plastic</b> Hanger: <b>Stainless steel</b> Room size: <b>Width 150cm x Length 200cm</b> Water quality: <b>Adequate</b> Gall trap: <b>Plastic at the bath floor</b> Chair: <b>bed like (movable and flexible) with smooth washable materials</b> Water heater: <b>Electrical heater/ Cooker</b> Wall/ floor materials: <b>Tiles/ cement</b>
			Changing room	2  (For staffs  (1- male, 1-female)	Shower: <b>Overhead shower</b> Shower tap: <b>Mix tap -cold/ hot water</b> Soap dish: <b>Plastic</b> Hanger: <b>Stainless steel</b> Room size: <b>Width 150cm x Length 200cm</b> Water quality: <b>Adequate</b> Gall trap: <b>Plastic at the bath floor</b> Water heater: <b>Electrical heater</b> Wall/ floor materials: <b>Tiles</b>	Shower: <b>Overhead shower</b> Shower tap: <b>Mix tap -cold/ hot water</b> Soap dish: <b>Plastic</b> Hanger: <b>Stainless steel</b> Room size: <b>Width 150cm x Length 200cm</b> Water quality: <b>Adequate</b> Gall trap: <b>Plastic at the bath floor</b> Water heater: <b>Electrical heater/ Cooker</b> Wall/ floor materials: <b>Tiles/ cement</b>
			Inpatient department (male and female wards)	4 (2- males, 2-females)	Shower: <b>Overhead shower &amp; Hand shower (for disabled)</b> Shower tap: <b>Shower tap: Mix tap -cold/ hot water</b> Soap dish: <b>Plastic</b> Hanger: <b>Stainless steel</b> Room size: <b>Width 150cm x Length 200cm</b> Water quality: <b>Adequate</b> Gall trap: <b>Plastic at the bath floor</b> Chair: <b>Movable, with smooth washable materials</b> Water heater: <b>Electrical heater</b> Wall/ floor materials: <b>Tiles</b>	Shower: <b>Overhead shower</b> <b>Hand shower (for disabled)</b> Shower tap: <b>Mix tap -cold/ hot water</b> Soap dish: <b>Plastic</b> Hanger: <b>Stainless steel</b> Room size: <b>Width 150cm x Length 200cm</b> Water quality: <b>Adequate</b> Gall trap: <b>Plastic at the bath floor</b> Chair: <b>Movable, with smooth washable materials</b> Water heater: <b>Electrical heater/ Cooker</b> Wall/ floor materials: <b>Tiles/ cement</b>

S/N	Level of health facility	Provision	Location	Description (Number/ User)	
3	District Hospital	Shower room	Labour ward	2 (for delivering mothers)	
		Soap dish	Labour ward		
4	Regional Referral Hospital	Towel/ cloth Hanger	Changing room for staff	2 (1- male, 1-female) in each department	
		Water supply	Changing room for staff		
		Materials walls	Changing room for staff		
		Water heater	Inpatient department (male and female wards),		
		Gall trap	(Internal medicine/Obstetrics/ Gynaecology/Surgical)		
		Sitting facility	Inpatient department (male and female wards),		
		Soap	(Internal medicine/Obstetrics/ Gynaecology/Surgical)		
		Shower room	Labour ward		3 (for delivering mothers)
		Soap dish	Labour ward		
		Towel/ cloth Hanger	Staff changing room		2 (1- male, 1-female) in each department )
Water supply	Staff changing room				
Materials walls	Inpatient department (male and female wards)	2 (1 – male, 1 – female in each inpatient department depending on the number of rooms/wards)			
Water heater	(Internal medicine				
Gall trap	Obstetrics/ Gynaecology				
Sitting facility	Surgical				
Soap	TB ward				
Shower	Postnatal ward				
Soap dish	Mental health)				
Towel/ cloth hanger	Labour ward		3 (for delivering mothers)		
Water supply	Labour ward				
Materials walls/ floors	Inpatient department (male and female rooms/wards)		2 (1 – male, 1 – female in each inpatient department depending on the number of rooms/wards)		
Water heater	Internal medicine				
Gall trap	Obstetrics/ Gynaecology				
Sitting facility	Surgical				
Soap	TB ward				
Shower	Postnatal ward				
Soap dish	Mental health				
Towel/ cloth hanger	Staff changing room	2 (1- male, 1-female) in each department			
Water supply	Staff changing room				

**ANNEX 4: TEMPLATE FOR RAPID ASSESSMENT OF WASH IN HCFs IN EMERGENCIES**

Assessor(s): _____ _____ _____	Contact Details: _____  Date of assessment: ____/____/____										
<b>SECTION 1: HEALTH FACILITY GENERAL INFORMATION</b>											
Health Facility Name and location (District, Town, Village etc.): _____											
GPS Long: ____° ____' ____"    GPS Lat: ____° ____' ____"	Number of Staff: _____										
<input type="checkbox"/> Hospital <input type="checkbox"/> Clinic <input type="checkbox"/> Health Post <input type="checkbox"/> Temp. Clinic	Number of Inpatients: _____										
<input type="checkbox"/> Cholera Treatment Centre <input type="checkbox"/> Cholera Treatment Unit	Number of Beds: _____										
<input type="checkbox"/> Therapeutic Feeding Centre <input type="checkbox"/> Other	Occupancy Rate: _____%										
Contact Person: _____	Outpatients/Day: _____										
Position: _____	Phone Number: _____										
<b>SECTION II: WATER QUANTITY [Tick the hazards encountered (one point for each)]</b>											
<input type="checkbox"/> Insufficient water quantity for all the daily needs in the health facility	Score ____/3										
<input type="checkbox"/> Daily interruptions in water supply or insufficient power or fuel supplies											
<input type="checkbox"/> Insufficient water storage (less than 24 hours backup supply)											
<b>SECTION III: WATER QUALITY [Tick the hazards encountered (one point for each)]</b>											
<input type="checkbox"/> Water is from an unimproved source or sources of contamination (toilets, waste, animals etc.) within 30m / 100ft of the water source.	Score ____/3										
<input type="checkbox"/> Water is unchlorinated, insufficiently chlorinated or is turbid (cloudy).											
<input type="checkbox"/> Broken water pipes, or uncovered or unsanitary water reservoirs.											
<b>SECTION IV: WATER POINTS [Calculate functional water point coverage and hazard score]</b>											
A: Estimate the <b>maximum</b> number of people at the health facility _____											
B: Count the number of functioning water points _____											
Calculate # of people per functioning water point (A/B) _____											
<table border="1" style="width: 100%; border-collapse: collapse;"> <thead> <tr> <th style="width: 25%;">Hazard Score</th> <th style="width: 12.5%;">0 points</th> <th style="width: 12.5%;">1 points</th> <th style="width: 12.5%;">2 points</th> <th style="width: 12.5%;">3 points</th> </tr> </thead> <tbody> <tr> <td>People per functional water point</td> <td>&lt;50</td> <td>50-100</td> <td>100-150</td> <td>&gt;200</td> </tr> </tbody> </table>		Hazard Score	0 points	1 points	2 points	3 points	People per functional water point	<50	50-100	100-150	>200
Hazard Score	0 points	1 points	2 points	3 points							
People per functional water point	<50	50-100	100-150	>200							
Comment(s):											

<sup>1</sup>Sufficient water quantity defined as at least 5 litres/consultation/day for outpatients, 40 litres/patient/day for inpatients, 60 litres per/patient/day for CTCs, 30 litres/patient/day for therapeutic feeding centres, 100 litres/patient/day for respiration disease isolation centres, 300 litres/patient/day for viral hemorrhagic fever isolation, 100 litres/intervention for operating theatres. See guidance notes.

<sup>2</sup>Unimproved drinking water sources include unprotected wells, unprotected springs, rivers, ponds, streams, and open canals.

<sup>3</sup>Insufficiently chlorinated defined as less than 0.5mg/l free chlorine residual at the tap or <1.0mg/l during diarrheal disease epidemics.

<sup>4</sup>Maximum number of people is defined as an estimate of the daily total number of staff, outpatients, inpatients plus inpatient carers.

<b>SECTION V: EXCRETA DISPOSAL [Calculate functional toilet coverage and hazard score]</b>					Score ____/3
A: Estimate the <b>maximum</b> number of people at the health facility _____					<b>Comment(s):</b>
B: Count the number of functioning toilets _____					
Calculate # of people per clean functional toilet (A/B) _____					
<b>Hazard Score</b>	<b>0 points</b>	<b>1 points</b>	<b>2 points</b>	<b>3 points</b>	
People per clean functional toilet	<25	25-50	50-100	>100	
<input type="checkbox"/> Evidence of open defecation (1 point)					
<b>SECTION VI: DRAINAGE [Tick the hazards encountered [score one point for each]]</b>					Score ____/3
<input type="checkbox"/> Pools of standing water observed at water points.					<b>Comment(s):</b>
<input type="checkbox"/> Potentially infectious wastewater from bathing, cleaning, or laundering activities visible in the health facility environment.					
<input type="checkbox"/> Storm-water drains or canals blocked, non-existent, or non-functional.					
<b>SECTION VII: WATER MANAGEMENT [Tick the hazards encountered [score one point for each]]</b>					Score ____/3
<input type="checkbox"/> Insufficient, inadequate or overflowing waste disposal containers.					<b>Comment(s):</b>
<input type="checkbox"/> No source separation of wastes (e.g. infectious, non-infectious, sharps).					
<input type="checkbox"/> Health-care wastes (needles, dressings etc.) observed in health facility grounds or spaces <b>or</b> health-care waste disposal area unfenced.					
<b>SECTION VIII: DISEASE VECTOR CONTROL MANAGEMENT [Tick the hazards encountered [score one point for each]]</b>					Score ____/3
<input type="checkbox"/> Lack of impregnated bed nets, indoor residual spraying, or damaged mosquito window screens in mosquito-borne disease risk areas.					<b>Comment(s):</b>
<input type="checkbox"/> Kitchen stores or prepared food unprotected from flies, other insects or rats.					
<input type="checkbox"/> Breeding sites (stagnant pools, food waste etc.) identified in / around facility.					

<sup>5</sup>A functional water point is defined as one that is in good working order supplying treated water for drinking, handwashing, cleaning or other uses with adequate flow rate (enough to fill a 20l bucket in under two minutes).

<sup>6</sup>A functional toilet is defined as one that is clean, in working order, of a type and location acceptable to users, and that safely separates excreta from users, groundwater and the environment. Toilets that are full, dirty, broken, or inaccessible should not be counted.

<sup>7</sup>Sufficient waste containers defined as at least 1 container <5m of where waste is generated or 1 container per 20 inpatients.

<sup>8</sup>Adequate waste containers defined as containers which protect staff and patients from the health-care waste (typically yellow puncture proof boxes for sharps, and color coded and lined 15-40 litre containers with lids for infectious, non infectious and hazardous waste)

<sup>9</sup>Adequate disinfection defined as at least daily cleaning of floors with detergent and disinfection of surfaces with 0.2% chlorine solution.



<b>SECTION IX: INFECTION CONTROL [Tick the hazards encountered [score one point for each)]</b>		<b>Score _____/3</b>
<p><input type="checkbox"/> Lack of at least one month supply of chlorine products, detergent or soap, sufficient cleaning equipment (buckets, mops etc.), or cleaning staff.</p> <p><input type="checkbox"/> Inadequate disinfection of beds, floors, walls, equipment, surfaces, <b>or</b> inadequate disposal of faeces and vomit from infectious patients.</p> <p><input type="checkbox"/> Lack of disinfection of hands (with soap or 0.05% chlorine solution) and feet (spraying or footbaths with 0.2% chlorine) at entry / exit of isolation areas.</p> <p><input type="checkbox"/> Lack of personal protective equipment (disposable gloves, aprons, masks).</p>		<b>Comment(s):</b>
<b>SECTION X: HANDWASHING [Tick the hazards encountered [score one point for each)]</b>		<b>Score _____/3</b>
<p><input type="checkbox"/> Absence of functional hand-washing points in ANY area where health-care is delivered (wards, consulting rooms, delivery rooms, operating theatres, etc.) <b>or</b> service areas (kitchen, laundry, toilets, waste zone, mortuary etc.)</p> <p><input type="checkbox"/> Patients and carers not informed of essential hygiene behaviours repeatedly starting within 30 minutes of arrival.</p> <p><input type="checkbox"/> Absence of posters reminding users of correct hand-washing procedures.</p>		<b>Comment(s):</b>
<b>Use the space below or additional pages to capture any additional notes, comments, recommendations, actions, or drawings</b>		<b>Total Hazard Score _____/30</b> <i>(Add individual scores together)</i>
<i>Any additional comments</i>		
<b>Send the completed form to _____ email address as soon as it is completed</b>		

<sup>10</sup>Adequate disposal defined as disposal into a structure that separates the contents from users, groundwater and environment.

<sup>11</sup>Functional hand-washing station points as one with continuous supply of water, soap, safe disposal of gray water, and possibly alcohol hand rub for repeat decontamination of clean hands. In all cases, there should also be soap and water for cleaning soiled hands.

<sup>12</sup>Functional hand-washing station points as one with continuous supply of water, soap, safe disposal of gray water, and possibly alcohol hand rub for repeat decontamination of clean hands. In all cases, there should also be soap and water for cleaning soiled hands.

## ANNEX 5: MONITORING FRAMEWORK FOR WASH IMPLEMENTATION AND PERFORMANCE

Topic	Indicator	Frequency	Key Issues to Monitor	Means of Verification	Who to Interview	Data Collector
<b>Water</b>	Water availability within 50 meters	Quarterly	Within 50 meters  Between 50 to 100 meters; 100 meters and beyond  These include the following: piped, public tap, standpipe, tube well/borehole, protected dug well, protected spring, rain water	Observation	Health Facility in charge	Ward Environmental Health Officer
	What is the main source of water for the facility?	Quarterly	No water source, piped into facility, piped onto facility grounds, public tap/ standpipe, tube well/ borehole, protected dug well, unprotected dug well, protected spring, unprotected spring, rainwater, bottled water, cart w/small tank/ drum, tanker truck, surface water, other (specify), don't know.	Observation	Health Facility in charge	Ward Environmental Health Officer
	What is the most commonly used source of water for the facility at this time?	quarterly	No water source, piped into facility, piped onto facility grounds, public tap/ standpipe, tube well/ borehole, protected dug well, unprotected dug well, protected spring, unprotected spring, rainwater, bottled water, cart w/small tank/ drum, tanker truck, surface water, other (specify), don't know.	Observation	Health Facility in charge	Ward Environmental Health Officer
<b>Water Access to Source)</b>	If no piped water on-site HF, what is the average walking time to and from the main source of water? (including waiting time)	Quarterly	Minutes		Health Facility in charge	Ward Environmental Health Officer
	Is the water outlet from this source available on-site, within 50 meters of the facility, or beyond 50 meters of facility?	Quarterly	On-site, within 500 meters of facility, beyond 500 meters of facility		Health Facility in charge	Ward Environmental Health Officer

Topic	Indicator	Frequency	Key Issues to Monitor	Means of Verification	Who to Interview	Data Collector
Water reliability	During the past 3 months, how many times was the water supply from this source interrupted for more than two hours at a time?	Quarterly	Number of incidents	Facility record	Health Facility in charge	Ward Environmental Health Officer
	Is there routinely a time of year when the facility has a severe shortage or lack of water?	Quarterly	Yes or No	Facility record	Health Facility in charge	Ward Environmental Health Officer
	Is there water storage tank	Quarterly	Available with storage capacity enough for three-days use Available with storage capacity enough for use more than three days Available but inadequate capacity for use in less than 3 days (72 hours) No water storage tank	Observation	Health Facility in charge	Ward Environmental Health Officer
Water quality assessment	Is water for drinking or cleaning treated	Weekly	Is water for medical use and drinking have chlorine residue of between 0.2 to 0.5mg		Health Facility in charge	Ward Environmental Health Officer
	Is there a toilet in functioning condition that is available for general outpatient client use?	Quarterly	These include the following: Flush/pour flush to piped sewer system or septic tank or pit latrine, (ventilated improved pit (VIP) or other) with slab, composting toilet.		Health Facility in charge	Ward Environmental Health Officer
Sanitation Access	What type of toilet is available for use by outpatients?	Quarterly	No functioning toilet = 1, Improved traditional toilet = 2, Flush toilet = 3, Flush toilet (but no water) = 4, VIP toilet = 5, Composting toilet (ecosan)= 6, Other (specify)=7		Health Facility in charge	Ward Environmental Health Officer

Topic	Indicator	Frequency	Key Issues to Monitor	Means of Verification	Who to Interview	Data Collector
<b>Sanitation access (and functionality) I</b>	Is there a toilet in functioning condition that is available for general outpatient client use?	Quarterly	Flush or pour flush toilet: flush to piped sewer system, flush to septic tank, flush to pit latrine, flush to somewhere else, flush don't know where.  Pit latrine: VIP, pit latrine with slab, pit latrine without slab/open pit, composting toilet, bucket toilet, hanging toilet/hanging toilet.  No functioning facility, bush, field.		Health Facility in charge	Ward Environmental Health Officer
<b>Sanitation access (number of toilets)</b>	How many of the mentioned (outpatient) toilets are there?	Quarterly	No functioning toilet = 1, Improved traditional toilet = 2, Flush toilet = 3, Flush toilet (but no water) = 4, VIP toilet = 5, Composting toilet (ecosan) = 6, Other (specify) = 7		Health Facility in charge	Ward Environmental Health Officer
<b>Sanitation access (functionality)</b>	How many of the mentioned (outpatient) toilets are currently functioning?	Quarterly	No functioning toilet = 1, Improved traditional toilet = 2, Flush toilet = 3, Flush toilet (but no water) = 4, VIP toilet = 5, Composting toilet (ecosan) = 6, Other (specify) = 7		Health Facility in charge	Ward Environmental Health Officer

Topic	Indicator	Frequency	Key Issues to Monitor	Means of Verification	Who to Interview	Data Collector
Sanitation access	What type of toilet is available for use by inpatients?	Quarterly	No functioning toilet = 1, Improved traditional toilet = 2, Flush toilet = 3, Flush toilet (but no water) = 4, VIP toilet = 5, Composting toilet (ecosan)= 6, Other (specify) = 7		Health Facility in charge	Ward Environmental Health Officer
	How many of the mentioned (inpatient) toilets are there?	Quarterly	No functioning toilet = 1, Improved traditional toilet = 2, Flush toilet = 3, Flush toilet (but no water) = 4, VIP toilet = 5, Composting toilet (ecosan)= 6, Other (specify) = 7		Health Facility in charge	Ward Environmental Health Officer
	How many of the mentioned (inpatient) toilets are currently functioning?	Quarterly	No functioning toilet = 1, Improved traditional toilet = 2, Flush toilet = 3, Flush toilet (but no water) = 4, VIP toilet = 5, Composting toilet (ecosan)= 6, Other (specify) = 7		Health Facility in charge	Ward Environmental Health Officer
Hygiene	Is there toilet for special needs male and female	Quarterly	Number		Health Facility in charge	Ward Environmental Health Officer
	Soap and running water or alcohol based hand rub	Monthly	1 – observed; 2- reported, not seen; 3 – not available	Signed cleaning roster	Health Facility in charge	Ward Environmental Health Officer
	Hand-washing soap (may be liquid soap).	Monthly	1 – observed; 2- reported, not seen; 3 – not available	Signed refill roster	Health Facility in charge	Ward Environmental Health Officer
	Alcohol based hand rub.	Monthly	1 – observed; 2- reported, not seen; 3 – not available	Signed refill roster	Health Facility in charge	Ward Environmental Health Officer

Topic	Indicator	Frequency	Key Issues to Monitor	Means of Verification	Who to Interview	Data Collector
<b>Disinfectant</b>	Disinfectant	Monthly	Chlorine-based or other disinfectant used for environmental disinfection.	Signed refill roster	Health Facility in charge	Ward Environmental Health Officer
	Disinfectant (e.g. chlorine, hibitane, alcohol).	Quarterly	1 – observed; 2- reported, not seen; 3 – not available		Health Facility in charge	Ward Environmental Health Officer
<b>Drainage</b>	All waste water removed rapidly and safely	Quarterly	1 – observed; 2- reported, not seen; 3 – not available		Health Facility in charge	Ward Environmental Health Officer
	No standing (stagnated) water	Quarterly	1 – observed; 2- reported, not seen; 3 – not available		Health Facility in charge	Ward Environmental Health Officer
<b>Laundry</b>	Sound drainage system(no stagnant water)	Quarterly	1 – observed; 2- reported, not seen; 3 – not available		Health Facility in charge	Ward Environmental Health Officer
	Separate staff handling soiled and clean linen	Quarterly	1 – observed; 2- reported, not seen; 3 – not available		Health Facility in charge	Ward Environmental Health Officer
<b>Health Care Waste Management</b>	Segregation and Collection procedures	Quarterly	Availability of colour-coded waste-bin Unavailability of colour-coded waste-bin	observation	Health Facility in charge	Ward Environmental Health Officer
	Storage and transportation	Quarterly	Proper storage is practiced No proper storage practiced	Observation	Health Facility in charge	Ward Environmental Health Officer
<b>Vector and vermin control</b>	Elimination of Health Care waste	Quarterly	Availability of functional incinerator Unavailability of functional incinerator	Observation	Health Facility in charge	Ward Environmental Health Officer
	Absence of disease vector and vermin	Quarterly	1 – observed; 2- reported, not seen; 3 – not available		Health Facility in charge	Ward Environmental Health Officer













